

TEXAS PARKS AND WILDLIFE

WILDLIFE MANAGEMENT ACTIVITIES AND PRACTICES

COMPREHENSIVE WILDLIFE MANAGEMENT PLANNING GUIDELINES

for the

**Trans-Pecos
Ecological Region**

Revised
April 2010



The following Texas Parks & Wildlife Department staff have contributed to this document:

Kirby Brown, Private Lands and Habitat Program Director (Retired)
Calvin Richardson, Technical Guidance Biologist, Midland
Ruben Cantu, Regional Director, Region 1, San Angelo
Linda Campbell, Program Director, Private Lands & Public Hunting Program
Linda McMurry, Private Lands and Public Hunting Program Assistant, Austin

With Additional contributions from:

Terry Turney, Rare Species Biologist, San Marcos
Trey Carpenter, Manager, Granger Wildlife Management Area
Dale Prochaska, Private Lands Biologist, Kerr Wildlife Management Area
Nathan Rains, Private Lands Biologist, Cleburne

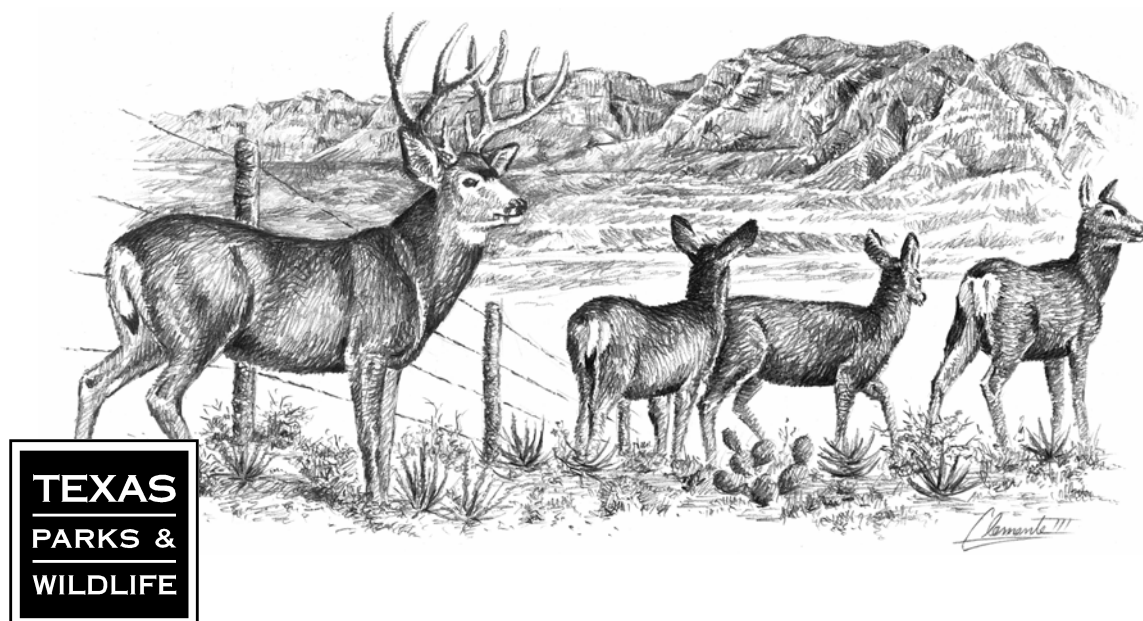

TABLE OF CONTENTS

Comprehensive Wildlife Management Planning Guidelines Trans-Pecos Ecological Region

INTRODUCTION

Specific Habitat Management Practices

HABITAT CONTROL
EROSION CONTROL
PREDATOR CONTROL
PROVIDING SUPPLEMENTAL WATER
PROVIDING SUPPLEMENTAL FOOD
PROVIDING SUPPLEMENTAL SHELTER
CENSUS

APPENDICES

APPENDIX A: General Habitat Management Considerations, Recommendations, and Intensity Levels
APPENDIX B: Determining Qualification for Wildlife Management Use
APPENDIX C: Wildlife Management Plan Overview
APPENDIX D: Livestock Management Recommendations
APPENDIX E: Recommendations for Brush Management in West Texas
APPENDIX F: Recommendations for Prescribed Burning in West Texas
APPENDIX G: Specific Management Recommendations for Mule Deer
APPENDIX H: Specific Management Recommendations for White-tailed Deer
APPENDIX I: Deer Survey Techniques in the Trans-Pecos Region
APPENDIX J: Harvest Record: An Essential Element in Deer Management
APPENDIX K: Specific Management Recommendations for Pronghorn Antelope
APPENDIX L: Specific Management Recommendations for Desert Bighorn Sheep
APPENDIX M: Specific Management Recommendations for Javelinas
APPENDIX N: Specific Management Recommendations for Black Bears
APPENDIX O: Specific Management Recommendations for Rio Grande Turkeys
APPENDIX P: Specific Management Recommendations for Bobwhite Quail
APPENDIX Q: Specific Management Recommendations for Scaled Quail
APPENDIX R: Specific Management Recommendations for Gambel's Quail
APPENDIX S: Nongame Wildlife Recommendations
APPENDIX T: Specific Management Recommendations for Black-capped Vireo
APPENDIX U: Forms
APPENDIX V: Wildlife Watering Facilities
APPENDIX W: Trapping Brown-headed Cowbirds to Reduce Songbirds Nest Parasitism
APPENDIX X: References
APPENDIX Y: Guidelines for Native Grassland Restoration
APPENDIX Z: Wildscapes Native Plant List and Bibliography
APPENDIX AA: Learn About Whitetails
APPENDIX BB: Learn About Turkey
APPENDIX CC: Bobwhite Quail in Texas
APPENDIX DD: West Texas Mule Deer
APPENDIX EE: Texas Pronghorn
APPENDIX FF: Pesticides and Brush Control
APPENDIX GG: Supplemental Feeding of Deer in West Texas
APPENDIX HH: Trans-Pecos Vegetation: A Historical Perspective
APPENDIX II: Minimum Requirements for Supplemental Shelter for the Trans-Pecos

COMPREHENSIVE WILDLIFE MANAGEMENT PLANNING GUIDELINES

for the

Trans-Pecos Ecological Region

(Prepared in partial fulfillment of the requirements of HB 1358 - Wildlife Management Property Tax Valuation and HB3123 - relating to the standards for determining whether land qualifies for appraisal for ad valorem tax purposes as open-space land based on its use for wildlife management.)

Introduction

The Texas Constitution and the legislature provides those landowners with a current 1-d-1 Agricultural Valuation (often known as an Ag Exemption) an opportunity to change from a traditional qualifying agricultural practice to wildlife management as a qualifying agricultural practice while maintaining the current valuation. HB 1358 by Representative Clyde Alexander provided that the landowner must implement and complete at least one management practice from at least three of the seven wildlife management activities listed in **Appendix A**. Most landowners interested in wildlife can meet this requirement, and implement several practices beyond the minimum required.

The 2001 legislative session passed HB3123, co-sponsored by Representative Bob Turner and Representative Clyde Alexander. This bill provided for further clarification of the standards required for determining whether land qualifies for appraisal as open-space land based on wildlife management. As a result of HB3123, more uniform standards of qualifying for wildlife management have been applied statewide.

Wildlife Management Tax Valuation

Land that qualifies for an agricultural valuation is appraised on its productivity value rather than on its market value. While many people refer to such land as having an “ag exemption”, in fact there is no such exemption—it is just a different method of calculating the land’s value for ad valorem tax purposes. Correctly speaking such land has an agricultural valuation.

Under Texas law, wildlife management is legally nothing more than an additional qualifying agricultural practice people may choose from in order to maintain the agricultural valuation on their land. Just as there is no real ag “exemption”, there also is no wildlife “exemption”. Wildlife management is not an additional appraisal, nor is it separate from “traditional” agriculture. For ad valorem tax purposes wildlife management is agriculture. There is no change in the ad valorem tax valuation with wildlife management, only a change in the qualifying agricultural practice.

Acreage Requirements

There are no minimum acreage requirements unless the landowner has purchased or otherwise acquired property that since the previous tax year has also been partitioned out of a larger agriculturally qualified tract. Only when a change in both ownership and tract size occur do minimum acreage requirements apply.

Landowners acquiring property that has been partitioned out of a larger qualifying tract since the previous tax year need to be certain that the property will meet the minimum size as set by the county. Refer to **Appendix B** for the maximum and minimum acreages by region, and to your county Central Appraisal District office for the minimum acreage size adopted. It is important to note that regardless of the property size, it must still be appraised for open-space use before it is eligible to change over to wildlife management use.

When a qualifying tract of land is broken into smaller tracts and sold, the standards for minimum eligible tract size take effect. These sizes are determined by location within the state. Within each area, the county has the ability to choose within a specified range the minimum qualifying acreage. Tracts below this minimum size are not eligible to manage for wildlife as their agricultural practice for ad valorem tax purposes. The exception is for landowners who are buying property in a Wildlife Management Property Owners' Association. Wildlife management property owners associations are community developments similar to wildlife management co-ops, but differ in that each person buying into the neighborhood must make a legal commitment to practice a certain level of wildlife management. Deed restrictions, conservation easements, property owner agreements, or other legally binding covenants insure that the habitat for wildlife is protected and managed in exchange for landowners being able to maintain an agricultural valuation based on wildlife management. If such legally binding covenants exist, the county may set a 1% or 2% lower minimum acreage requirement.

These same lower minimum acreages also apply to landowners who have habitat for threatened or endangered species, or a species of concern. While the actual presence of the species on the property is not required, a qualified wildlife professional must verify that the habitat for the species does in fact exist on the property before this exception is granted by the county.



Although landowners with smaller tracts of land are encouraged to work cooperatively with their neighbors for some wildlife management practices, such as conducting a population census, each landowner must also individually be doing three practices of an appropriate intensity level on their property, submit their own individual wildlife management plan and be able to qualify on their own.

The Wildlife Management Plan

This guide is intended to provide landowners with information to develop their own plans. The plan may be as simple or as extensive as the landowner chooses. The practices described in this guide are intended only as guidelines. Certain site-specific situations may necessitate changes that can be allowed, if based on trained resource professionals' recommendations.

All landowners are required to develop and submit a wildlife management plan to the

county Central Appraisal District along with their 1-d-1 Open Space Appraisal Application. All wildlife management plans must be on the form provided by Texas Parks & Wildlife Department. This form, PWD 885-W7000, is included in **Appendix Y**.

While a comprehensive and highly detailed written wildlife management plan as described in these guidelines is not required by the county, it is highly recommended that the landowner go through this lengthier exercise and use this lengthier plan as a guide when filling out the required PWD 885-W7000 wildlife management plan form. The plan must address a separate practice in at least three of the seven wildlife management categories.

A wildlife management plan describes historic and current land use practices, establishes landowner goals and objectives (also family goals if desired) for the property, and describes specific activities and practices designed to benefit wildlife species of interest and their habitats. **This is the landowner's plan**, designed by the landowner, with the possible assistance of a wildlife biologist of the Texas Parks and Wildlife Department [TPWD], Texas Cooperative Extension [TCE], USDA Natural Resource Conservation Service [NRCS, formerly Soil Conservation Service - SCS], Texas Forest Service [TFS], or other qualified wildlife biologist. Efforts to perform activities identified in the plan are completely voluntary on the part of the landowner, except those practices that are necessary to maintain the agricultural appraisal for wildlife management use.

A complete plan will likely include elements of all seven listed wildlife management activity categories. While Texas Parks and Wildlife Department biologists are available to assist landowners in developing a wildlife management plan for ad valorem tax purposes, it should be noted that the Department's participation is not required in order for the wildlife management plan to be valid.

What Paperwork to File

All paperwork for changing the land's qualifying agricultural practice over to wildlife management must be filed with the Chief Appraiser at the county's Central Appraisal District. No paperwork is required to be filed with Texas Parks and Wildlife Department. Landowners will need to complete a 1-d-1 Open Space Appraisal Application available from their Central Appraisal District and attach to it the completed PWD 885-W7000 wildlife management plan that is included in **Appendix Y**.



With 95% of Texas privately owned, the wildlife that belongs to the people of Texas depends on private landowners to voluntarily provide them with quality habitat.

Habitat Control

Grazing Management
Prescribed Burning
Range Enhancement
Brush Management
Riparian Management and Enhancement
Wetland Enhancement
Habitat Protection for Species of Concern
Prescribed Control of Native, Exotic, and Feral Species
Wildlife Restoration

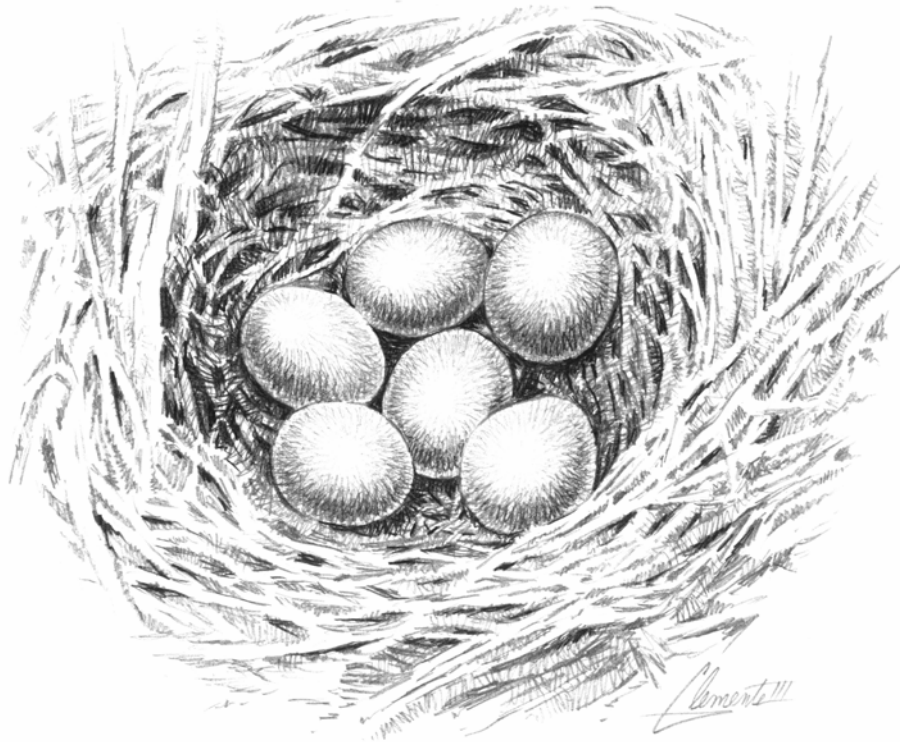

HABITAT CONTROL (HABITAT MANAGEMENT)

Introduction

Habitat is defined as the physical and biological surroundings of an organism and provides everything that a living organism needs to survive and reproduce. The three basic requirements of any wildlife species to survive and reproduce are food, water, and shelter. Quite frequently, we as land managers tend to focus on a specific wildlife species and its needs as opposed to the habitat or community in which they live. The key to managing wildlife and our natural resources is to use a holistic approach and promote healthy ecosystems. Single species deserve less attention, while the system in which they thrive requires more. Knowing how a system functions, and applying the techniques with which that system developed is imperative for its continued health and existence.

Ecosystems are dynamic and continuously changing. Succession is the change in plant species composition and structure over time and it is succession that we as land managers are trying to manipulate. Generally the earlier the successional stage the greater the plant diversity and the greater the number of wildlife species that are benefited. Although some wildlife species are dependent on a late successional stage or even several stages, managing for diversity is important. Maintaining a variety of habitat types, while at the same time promoting plant diversity in both species composition and structure within each habitat type, should be the goal of all good wildlife management programs.

Aldo Leopold, who is known as the “Father of Modern Wildlife Management”, authored a book in 1933 titled *Game Management*. In this textbook Leopold wrote "...game can be restored by the *creative use* of the same tools which have heretofore destroyed it - ax, plow, cow, fire, and gun".

Habitat control or habitat management, as it is most often referred, is the active application of these “tools” to the land in order to promote land health and enhanced availability of the 3 basic requirements (food, cover, water) to all wildlife species. It is very important that land managers today understand basic ecological principles such as plant succession, plant growth, food chains, and water and mineral cycles, as well as how they affect wildlife and range management. This not only produces high quality habitat and animals, but also can lead to more stable conditions during stress periods such as droughts and winter.

Grazing Management

Some people consider livestock grazing to be incompatible with wildlife management. Although this can be the case, sound grazing management can be beneficial to wildlife habitat. Focusing on good land management as opposed to strictly livestock production allows a landowner to adjust the presence or absence of livestock as well as a grazing time and intensity level that is beneficial for both plant health and diversity.



Grasses evolved with grazing pressure.

Historically great herds of bison roamed the central part of the United States and stayed constantly on the move in search of new forage and in front of predators. Bison came into an area, grazed it down, and left. Herds were never in any given area for an extended length of

time. Sheer numbers of bison in the herd did not allow the animals to be selective about plants that were bitten; animals were forced to eat every palatable plant in an area. This type of grazing did several things to sustain a diverse mid- and tall-grass plant community. The intense pressure left a lot of tilled and well fertilized soil, it decreased the overall quantity of grass, allowing sunlight to reach the lower growing forbs (weeds & wildflowers), and allowed those grasses with deeper root systems to respond quicker, during the absence of bison, than those with shallower root systems. While intense for a short time period, this type of grazing provided long rest periods of the range, allowing for rapid responses of annual forbs and grasses. The final result was more plant diversity and more wildlife foods. Bison opened stands of dense grasses, providing more food for deer, turkey, quail, prairie chicken, and songbirds. Without grazing pressure neither the grasses nor the forbs respond the same. The diversity as well as the health of the system is diminished. Undoubtedly, bison were a major force that shaped the ecosystem.

European man brought with him his own form of agriculture and the range appeared unlimited in its ability to support a great number and variety of livestock (cattle, sheep, goats, oxen, hogs, and horses). The demise of the bison and changes in land use patterns eventually brought fences and livestock were increasingly grazed in pastures with limited or no rest periods. Forage availability and production is dependant on stocking rates, rest, and rainfall. Sedentary grazing or limited rotation grazing with even average stocking rates and rainfall can create severely abused and overgrazed range. Grasses are continually grazed beginning with the most palatable first and on down the line until the plant community is primarily less desirable shallow rooted grasses and a few undesirable forbs. Overall plant diversity decreases. An abused range lacks adequate groundcover and available browse to support healthy livestock and wildlife populations. Overgrazing with domestic livestock causes problems in managing for healthy ecosystems.

Good grazing management starts with the basics: 1) the kind and class of livestock grazed 2) stocking rate or intensity 3) duration of grazing to provide rest periods for the pastures and 4) excluding livestock from sensitive areas to promote vegetation protection and/or recovery.

In an ideal program the goal is high intensity short duration. The stocking rate is such that every plant should be bitten off once during each grazed period or rotation. Sedentary grazing allows plants to be bitten over and over starting with the most palatable first. The less desirable species keep growing while the more palatable ones continue to get bitten. This can result in a pasture being underutilized, but still overgrazed and eventually the removal of your most desirable species. Having enough animals to bite the plants only once means livestock can only stay in one place for a short period of time before they have to be moved to another pasture. High intensity short duration grazing requires a number of pastures within the grazing system to allow for extended rest periods.

High intensity short duration grazing systems allow livestock to act as a tool to manipulate and enhance wildlife habitat and plant diversity as the bison did historically in our grassland and savannah ecosystems. There are a number of variations of this system, finding one that you are able to implement on your property is the key. If it is unrealistic to divide a property into enough small pastures to both sufficiently graze and rest the range, a small landowner may want to contact neighbors to pool property and allow each property to serve as a pasture in a grazing rotation. Properties without these options may have to use prescribed burning and/or mowing to achieve some of the results and benefits of grazing.

For additional information see Appendix D. Contact the Texas Parks and Wildlife Department's Kerr Wildlife Management Area at 830-238-4483 or write to Kerr WMA, 2625 FM 1340, Hunt, TX 78024 to schedule a visit and see the effects of both grazing systems and "over-rest" situations.

Prescribed Burning

Bison were not the only major force shaping the system in which pronghorn antelope, black bear, wolf, white-tailed and mule deer, turkey, quail, and prairie chicken thrived historically. Fires, natural and man-made, played an integral role in managing that system. Fire is a natural ecological factor to which native vegetation is well adapted. Since the 1850s, man has suppressed fire, and the grasslands and savannahs that were once dotted with occasional mottes of trees and forests only along drainage systems are now dominated by brush and woodlands. Europeans suppressed fire to prevent damage to wooden structures, farmlands, fences, and grazing lands. In turn this eliminated or reduced the role that fire played in maintaining ecosystems that were dominated by herbaceous vegetation.



Prescribed burning is the planned application of fire to set back succession. It improves habitat and plant diversity and returns nutrients to the soil. Burning can improve accessibility, increase both quantity and quality of forage and browse production, suppress brush and cactus, improve grazing distribution of livestock and wildlife, and remove excessive mulch and debris. Prescribed burning is a tool used to maintain desired vegetation composition and structure.

Achieving a management objective requires a particular set of conditions for burning and a specific type of fire or burn prescription. A burn prescription defines the range of conditions and factors under which a fire boss will light a fire to meet these specific objectives. Factors that influence the type of fire and its intensity include time of the year, fuel quantity and moisture, air temperature, humidity, soil moisture, wind speed, geographic area, and direction of the flame front movement in relation to the wind. Generally summer fires are hotter type fires and fall-spring fires are cooler burning fires. As fuel quantity goes up and fuel moisture goes down the higher the intensity of the fire. The same goes for the higher the wind speed and air temperature and the lower the humidity and soil moisture, the hotter the fire. Fire set to move in the same direction as the wind is a headfire and fire set to move against the wind is a backfire. Headfires burn hotter than backfires.

The plant response after a fire is influenced by fire intensity, plant condition at the time of the burn as well as weather conditions and grazing management practices following the burn. For example forbs are prolific seed producers and valuable resource for white-tailed deer and other wildlife species. Forb seedlings are highly susceptible to fire, and a late winter burn after annuals have germinated may reduce forb production for the following growing season. A winter burn used to target certain evergreen trees or shrubs, such as Ashe juniper (cedar) or

yaupon holly, is less likely to harm deciduous trees, such as oaks, than a late summer fire used to target the same species. Burned pastures can be grazed immediately to reduce grasses that compete with forbs or to make use of now palatable prickly pear, then deferred to allow the pasture to rest.

A successful prescribed burn includes 3 basic steps: 1) develop a burn plan which should include management goals and objectives, burn prescription, safety plan, description and map of the burn unit, smoke management, legal requirements, contacts and notifications, control and firing plan, and evaluation 2) a safe and effective execution of the burn on the planned site and 3) good range, livestock, and wildlife management to maximize the effects of the burn. Inexperienced managers should ask for assistance and/or advice from agencies such as Texas Parks & Wildlife or the Natural Resources Conservation Service. While instructional materials are available, it is suggested that the novice assist on a burn conducted by an experienced person before attempting a prescribed burn.

For additional information contact the Texas Parks and Wildlife Department's Kerr Wildlife Management Area at 830-238-4483 or write to: Kerr WMA, 2625 FM 1340, Hunt, TX 78024 to schedule a visit and see the effects of a good prescribed burn program.

Range Enhancement

Mismanagement and overgrazing can lead to abused rangeland. Continuous over-utilization by livestock and/or white-tailed deer and exotics can remove certain desirable and highly palatable plants from a system. Past land use practices such as mechanical clearing or farming may cause some plants to become rare or even nonexistent on certain ranges. Range enhancement is the re-establishment or enhancement of plant communities with native grasses and forbs. These plants provide both food and cover for wildlife and help to meet the three basic requirements.

Seeding mixes should provide for maximum native plant diversity and should include many broadleaf plants which are important forage for wildlife and seed production. Range enhancement should include appropriate plants or seed mixtures as well as methods of application for the particular ecological region where the property is located. Non-native species are not recommended and should be used only in rare and very specific cases. Even then non-natives should not exceed 25% of the seeding mix.

Managing, restoring, and/or protecting native grass prairies is also considered range enhancement. This may or may not include actual reseeding but could include utilizing some of the "tools" to manage for the earlier successional stages of a native prairie. Grazing, burning, and mechanical disturbance (plow) are all options to manage and restore native prairie.

For additional information see Appendix E.

Brush Management

Historically, fire had a huge impact on most plant communities in the Trans Pecos, and light numbers of bison periodically grazed the region. The removal of these major influences resulted in dramatic changes in most plant communities. Without fire and a high intensity short duration type grazing regime plant communities began to see an increase in woody plant species and a change from grassland or savannah communities to more brushland or woodland habitat types.

As brush continues to increase and begins to form closed canopies, cutting off sunlight to the area underneath, grass and forb production as well as overall diversity decreases. Some

woody species tend to increase at rates greater than others, such as redberry juniper or mesquite, and can begin to dominate a system. Along with this domination come other changes that take place beyond what is realized by observation. Woody plant encroachment has a tremendous impact on the ecosystem by competing with and reducing herbaceous vegetation, increasing soil erosion, and decreasing water absorption and infiltration.

As mentioned before a diversity in both plant composition and structure within differing habitat types is the key to successful wildlife management. An area that is dominated by any single type or species of plant is rarely going to meet the needs of even a single species of wildlife. Again, utilizing the “tools” that Leopold described is the key to managing your property and providing the adequate amount and arrangement of woody cover to meet the needs of a multitude of wildlife species.

Although prescribed fire and proper grazing management can reduce the need for brush management, the “axe” may be needed when a particular piece of property is beyond the point that utilizing other tools is realistic. The axe is rarely used in the 21st century when dealing with extensive brush or woody encroachment. Today chainsaws, herbicide and mechanical equipment such as bulldozers or tree shears take the place of the axe and serve to set back succession.

Brush management, when needed, is only part of a good habitat management program and should be planned carefully to help meet overall management goals. The primary principles that drive any good brush management program are: 1) extent 2) pattern 3) selection and 4) method. The extent to which brush is going to be cleared or treated is the first step in developing a program. Overall goals of the property should be examined and can help to dictate the amount of clearing needed to meet wildlife, livestock, water conservation, and/or aesthetic expectations. Clearing a large portion of the brush may be best from a livestock production standpoint, but if your overall goal includes white-tailed deer management you may only want to clear 50%. Individual plant treatment may be all you need, depending on the amount of brush present. The pattern in which brush is cleared should consider wildlife cover and accessibility. This may include cover from predators, nesting cover, and loafing or roosting cover. Maintaining travel corridors that link bedding and foraging areas is also very important. Selection includes both the site and the species of brush to be cleared. Soil type and slope are key considerations for minimizing erosion. Woody plants on specific soil sites may be selected for treatment because of greater response potential of grasses and forbs. Also Removal of desirable plant species should be kept to a minimum. The proper method of treatment can usually be determined by total cost analysis, soil erosion issues, and the type or species of brush which is being targeted.

Riparian Management and Improvement

Riparian area refers to the low lying areas on either side of a stream course. Management or improvement of the vegetation in these areas helps to alleviate erosion and protect water quality. Much of our bottomland hardwood forests that existed historically have been cleared for agricultural production, degraded through improper timber harvest or other mismanagement, or flooded by the construction of flat water reservoirs. Bottomland hardwoods have been referred to as the single most important wildlife habitat type and provide a wealth of benefits for wildlife, erosion control, flood control, water quality, water retention, and ecosystem health. Managers should attempt to restore and/or manage these riparian areas that include bottomland hardwoods, bogs, mixed pine and hardwood forests, and natural wetlands to promote ecosystem health and diversity.

Riparian management and improvements can include providing alternate livestock watering sites, deferring livestock from riparian areas during critical periods, excluding livestock from pastures with riparian areas, herbaceous plantings or seeding in degraded riparian zones, or planting native riparian woody shrubs and trees that were historically present. Attention should specifically be given to protection of turkey roosting areas and snag retention for cavity nesters.

Wetland Improvements

It has been estimated that Texas has lost 54% of its total wetland acreage in the last 200 years. Wetlands were at one time regarded as waste-lands and nothing more than breeding grounds for insects, pests, and disease. They were considered obstacles to progress and development and were readily converted to other land uses. It is only in the recent past that wetlands were recognized as some of the most ecologically important systems on earth. Wetlands are invaluable for their ability to prevent erosion, purify water, prevent and minimize flooding, and replenish groundwater resources. They provide humans with fossil fuels and food and wildlife with invaluable habitat. Managing, protecting, restoring, or creating wetland habitat plays an integral part in a successful wildlife program.

Texas wetlands may include swamps, bottomland hardwoods, marshes, bogs, springs, playa lakes, or saline lakes. They are found along rivers, streams, lakes, and ponds; in uplands where surface water collects and at points of groundwater discharge such as springs or seeps. Wetlands are characterized by 1) water or saturated soils for at least a portion of the year 2) plants that are adapted to wet environments (hydrophytic vegetation) and 3) soils that develop under depleted oxygen conditions (hydric soils). Managing for wetland improvement can involve any practice that enhances, restores, or creates these 3 characters. Setting back succession in an existing wetland by using the axe, cow, plow, or fire to ensure the integrity of the wetland plant community can be important to the production of wetland wildlife food sources. Closing a ditch that was once used to drain an existing wetland or creating a ditch or drilling a water well to increase water flow into a wetland can be very important to maintaining the hydrology or flooding regime needed for that wetland to continue to function. Cleaning out a seep or spring which is experiencing reduced flow due to siltation can provide more permanent or seasonal water. And building a levee with water control structures to manage the water regime and provide water during the growing season and for fall and winter migrants can be an important habitat source for waterfowl or shorebirds.

The management options for wetlands are as diverse as the wetlands themselves. Where the opportunity exists, wetland management provides unique opportunities for habitat management that benefits a great diversity of wildlife and overall land health.

Habitat Protection for Species of Concern

New and changing land use practices and the exclusion of fire and high intensity short duration grazing by bison has had negative impacts on a number of wildlife species. Endangered, threatened, or rare wildlife species are a by product of endangered and rare habitat. Habitat protection includes managing or developing additional areas to increase nesting sites, feeding areas, and other critical habitat types to overcome limiting factors and meet the 3 basic needs of certain wildlife species.

Habitat protection as it is defined here can include setting aside critical areas of habitat, managing vegetation for a particular species, maintaining overstory vegetation from degradation, and annually monitoring the species of concern. Management for migrating,

wintering, or breeding neotropical birds and should follow specific guidelines provided by the Texas Parks and Wildlife Department specific to your ecological region. Leopold wrote "...game can be restored by the *creative use* of the same tools which have heretofore destroyed it - ax, plow, cow, fire, and gun". Broadscale habitat management for nongame species, just as for game species, should include those practices that promote an increase in plant abundance and diversity in both composition and structure.

Contact the Texas Parks and Wildlife Department for approved management guidelines before implementing activities designed to protect or enhance habitat for endangered species. For additional information see Appendix I.

Prescribed Control of Native, Exotic, and Feral Species

The appearance of most Texas rangelands is very different today compared to 150 or 200 years ago. The expansive grasslands, which were dotted with an occasional motte of trees, are no more. Mid- and tallgrass communities have been replaced with shortgrass communities or even pastures of exotic grasses. The expansive native grasslands were replaced by brush and woodlands which in turn influenced the type and number of wildlife species that flourish. The Texas white-tailed deer population is at an all time high and many ranges support more exotic and feral species now than ever before. The changing land management practices, combined with grazing pressure of too many deer, exotics, and livestock have degraded the quality of wildlife habitat across the state. Over-utilized rangelands have poor plant diversity, are often dominated by exotic or lesser quality vegetation, and support poor wildlife diversity. There may be little or no groundcover to capture runoff, rain water is lost, and groundwater is not recharged. The whole system is suffering. In many areas of Texas using the gun, as a tool, to manage populations at or below the carrying capacity of the range is essential in providing quality wildlife habitat for a multitude of wildlife species.

White-tailed deer have a high reproduction potential, and in the absence of natural predators, can quickly overpopulate a range. If white-tailed deer are allowed to overpopulate, they can have negative effects on the habitat. Deer consume the most palatable plant species first, and excessive browsing pressure can eliminate these preferred plant species from the range. This reduces plant diversity and has negative impacts on all wildlife species, not just white-tailed deer. Once a range is damaged by overgrazing, it can take years to recover, even after deer numbers are reduced to an appropriate level. The most effective way to regulate deer numbers is through hunting. Hunting allows the land manager to maintain deer numbers at a level that the habitat can support without causing damage to the habitat. In addition to habitat damage, deer from overstocked ranges generally have poor fawn survival, low body weights, and poor antler quality. The most effective way to reduce deer numbers is through the harvest of doe deer at appropriate levels. Once deer numbers are at a desired level, doe harvest must be continued to maintain the population at a desirable level.

Each time a deer hunter chooses to shoot a deer, or not to shoot a deer, a management decision that will affect the future of that deer herd and habitat is made. For example, choosing to shoot, or not to shoot a doe, affects the sex ratio and reproductive potential of the herd. Choosing to shoot, or not to shoot, a yearling buck affects the current and future age structure of the buck population. Therefore, not only can the gun be used to manipulate deer numbers, it can also be used to manipulate sex ratios, reproductive potential, and age structure of the herd.

Exotic and feral species, that may include feral hogs or any number of exotic ungulates,

compete directly with native wildlife species for available habitat. Population reduction or elimination of these non-native species will benefit your native wildlife management program (see Predator Control Activity for additional information on feral species).

In addition land managers should attempt to control or eradicate exotic vegetation that in many cases can dominate native habitats and reduce overall vegetation diversity. Native vegetation, as opposed to introduced species, provides for better, more productive wildlife habitat. Removal of species such as chinaberry, Chinese tallow, weeping lovegrass, coastal bermuda grass, King Ranch bluestem, and Kleberg bluestem will reduce competition with native vegetation. Effective control of exotic vegetation is dependant on the species, and the method used should be an accepted or proven practice in the ecological region where the property is located.

Wildlife Restoration

Wildlife restoration has experienced numerous success stories. These efforts have resulted in stable populations of beavers, wood ducks, and white-tailed deer. Without the aid of private landowners these successes would not have been possible. Landowners provide trapping sites for capture of the animals to be relocated, but more importantly they manage the habitat on which these animals depend. Wildlife restoration means restoring or improving habitat for targeted species as part of an overall reintroduction program in a TPWD-approved restoration area.

Erosion Control

Pond Construction and Repair
Gully Shaping
Streamside, Pond, and Wetland Revegetation
Herbaceous and/or Woody plant Establishment on Critical Areas
Dike/Levee Construction and Management
Establishing Water Diversion



Erosion Control

Any active practice that attempts to reduce or keep soil erosion to a minimum for wild animals' benefit is erosion control.

Erosion is the detachment and movement of soil by moving water, wind or ice. When raindrops hit an uncovered soil surface, they dislodge and detach soil particles (*splash erosion*). If there is more rainfall than the ground can absorb, the resulting runoff carries these detached soil particles away.

Erosion is a natural process that cannot be stopped; however, human activity such as earthmoving and tillage can accelerate the process. The erosion process advances through several stages.

- **Sheet erosion** is the removal of a fairly uniform layer of soil from the soil surface by shallow overland flow.
- **Rill erosion** occurs as shallow sheet flow concentrates into small channels. Flow in these channels causes further erosion and carries soil particles away.
- **Gully erosion** is an accelerated form of rill erosion where the channels are much deeper and carry away larger quantities of soil.

Raindrop impact on bare soil surface can also form a "crust" or pan on the soil surface that can be difficult for water to infiltrate. This creates more runoff and less water available to plants, which can decrease plant growth and ground cover leading to further erosion.

According to the U.S. Department of Agriculture the United States loses more than 2 billion tons of topsoil each year to erosion. Erosion removes fertile soil rich in nutrients and organic matter, which reduces the ability of plants to establish, grow and remain healthy in the soil. A reduction in plant growth and subsequent plant residue causes less soil cover, allowing the erosion process to perpetuate and become worse. This in turn affects the wildlife species dependent upon the affected plant communities.

Water Quality and Conservation

Erosion not only causes loss of soil productivity but also creates water quality problems once the sediment leaves the site and enters surface waters. The EPA has declared that sediment contamination of our surface waterways is one of the biggest threats to our nation's water resources. When eroded sediment is transported from its site of origin to nearby water bodies it can also carry fertilizers, pesticides and other contaminants attached to the soil particles.

Water that is loaded with sediments can lead to reduced drainage capacity, increased flooding, decreased aquatic organism populations, decreased commercial and recreational fishing catches, clogged and damaged commercial and industrial irrigation systems, increased expenditures at water treatment plants to clean the water, and decreased recreational and aesthetic value of water resources. Some erosion control practices include:

Pond construction is building a permanent water pond to prevent, stop or control erosion as

an approved Natural Resource Conservation Service (NRCS) watershed project while providing habitat diversity and benefiting wildlife. Whenever possible, owners should use ponds to help create or restore shallow water areas as wetlands and for water management.

Gully shaping involves reducing erosion rates on severely eroded areas by smoothing to acceptable grades and re-establishing vegetation. An area should be seeded with plant species that provide food and/or cover for wildlife.

Streamside, pond and wetland revegetation means revegetating areas along creeks, streams, ponds and wetlands to reduce erosion and sedimentation, stabilize streambanks, improve plant diversity and improve the wildlife value of sensitive areas.

Establishing native plants on critical areas is one method of controlling erosion. These plants also can provide food and/or cover for wildlife and restore native habitat. Some of the ways to establish these plants are listed below.

- Establish and manage wind breaks/shelterbelts by planting multi-row shelterbelts (at least four rows that are 120 feet wide by 1/4 mile), renovate old shelterbelts (re-fence, root-prune and replace dead trees) and establish shrub mottes.
- Establish perennial vegetation on circle irrigation corners by revegetating at least every other corner to reduce erosion and sedimentation, improve plant diversity and improve wildlife habitat.
- Plant permanent vegetation on terraces and field borders to reduce erosion, improve plant diversity and improve wildlife habitat.
- Conserve tillage/no-till farming practices by leaving waste grain and stubble on the soil surface until the next planting season to provide supplemental food or cover for wildlife, control erosion and improve the soil tilth.
- Manage Conservation Reserve Program (CRP) cover by maintaining perennial cover established under the CRP on erodible sites using proper management techniques such as haying, prescribed grazing or burning.

Dike, levee construction or management is a way to establish and maintain wetlands or slow runoff to control or prevent erosion and to provide habitat for wetland-dependent wildlife. Levee management may include reshaping or repairing damage caused by erosion and revegetating levee areas to reduce erosion and sedimentation and stabilize levees. This practice may include fencing to control and manage grazing use.

Water diversion systems also can be installed to protect erodible soils and divert water into wetlands to provide habitat for resident and migratory water birds and wetland-dependent species.

Minimizing Erosion

Building and construction projects can be major causes of erosion. Landowners can take steps to minimize erosion during these projects by following a few simple, commonsense precautions.

- Plan construction activities during the spring and summer months, so that erosion control measures can be in place when rain comes.
- Examine your site carefully before building. Be aware of the slope, drainage patterns and soil types. Proper site design will help you avoid expensive stabilization work.

- Preserve existing vegetation as much as possible. Limit grading and plant removal to the areas under current construction. (Vegetation will naturally curb erosion, improve the appearance and the value of your property, and reduce the cost of landscaping later.)
- Use fencing to protect plants from fill material and traffic. If you have to pave near trees, do so with permeable asphalt or porous paving blocks.
- Preserve the natural contours of the land and disturb the earth as little as possible. Limit the time in which graded areas are exposed.
- Minimize the length and steepness of slopes by benching, terracing, or constructing diversion structures. Landscape benched areas to stabilize the slope and improve its appearance.
- As soon as possible after grading a site, plant vegetation on all areas that are not to be paved or otherwise covered.
- Control dust on graded areas by sprinkling with water, restricting traffic to certain routes, and paving or graveling access roads and driveways.

Temporary Measures to Stabilize the Soil

Grass provides the cheapest and most effective short-term erosion control. It grows quickly and covers the ground completely. To find the best seed mixtures and plants for your area, check with your local nursery, the Texas Department of Agriculture, the Natural Resource Conservation Service, the Texas Cooperative Extension Service and Texas Parks and Wildlife Department.

Mulches hold soil moisture and provide ground protection from rain damage. They also provide a favorable environment for starting and growing plants. Easy-to-obtain mulches are grass clippings, leaves, sawdust, bark chips and straw. Straw mulch is nearly 100% effective when held in place by spraying with an organic glue or wood fiber (tackifiers), by punching it into the soil with a shovel or roller, or by tacking a netting over it. Commercial applications of wood fibers combined with various seeds and fertilizers (hydraulic mulching) are effective in stabilizing sloped areas. Hydraulic mulching with a tackifier should be done in two separate applications: the first composed of seed fertilizer and half the mulch, the second composed of the remaining mulch and tackifier. Commercial hydraulic mulch applicators - who also provide other erosion control services - are listed under "landscaping" in the phone book.

Mats of excelsior, jute netting and plastic sheets can be effective temporary covers, but they must be in contact with the soil and fastened securely to work effectively.

Roof drainage can be collected in barrels or storage containers or routed into lawns, planter boxes and gardens. Be sure to cover stored water so you don't collect mosquitoes, too. Excessive runoff should be directed away from your house and into wildlife watering facilities. Too much water can damage trees and make foundations unstable.

Structural Runoff Controls

Even with proper timing and planting, you may need to protect disturbed areas from rainfall until the plants have time to establish themselves. Or you may need permanent ways to transport water across your property so that it doesn't cause erosion. To keep water from carrying soil from your site and dumping it into nearby lots, streets, streams and channels, you need ways to reduce its volume and speed. Some examples of what you might use are:

- **Riprap** (rock lining) to protect channel banks from erosive water flow.
- **Sediment trap** to stop runoff carrying sediment and trap the sediment.
- **Storm drain outlet protection** to reduce the speed of water flowing from a pipe onto open ground or into a natural channel.
- **Diversion dike or perimeter dike** to divert excess water to places where it can be disposed of properly.
- **Straw bale dike** to stop and detain sediment from small unprotected areas (a short term measure).
- **Perimeter swale** to divert runoff from a disturbed area or to contain runoff within a disturbed area.
- **Grade stabilization** structure to carry concentrated runoff down a slope

Using Livestock to Repair the Effects of Erosion

Overgrazing can cause erosion; however, in some instances livestock can be used to reverse the effects of erosion. When bare soil is exposed by excessive grazing or other disturbances, an algal cap can develop on the surface of the soil that over time becomes impenetrable to water. Grazing deferment provides little benefit to these capped sites. Livestock grazing at a proper stocking rate can help to break the capped soil, allow rainfall infiltration and vegetation growth, and reduced erosion potential.

For information on which plants provide the best erosion control and wildlife benefit, consult the Texas Plant Information Database at <http://tpid.tpwd.state.tx.us/index.asp>.



Algal capping on the soil causes a nearly impenetrable barrier to rainfall, increasing the potential for erosion. Proper grazing helps prevent capping from occurring.

Predator Control

Imported Red Fire Ants
Brown-headed Cowbirds
Grackle, Starling, and House Sparrow Control
Coyotes
Feral Hogs
Raccoons, Skunks, Feral Cats and Dogs

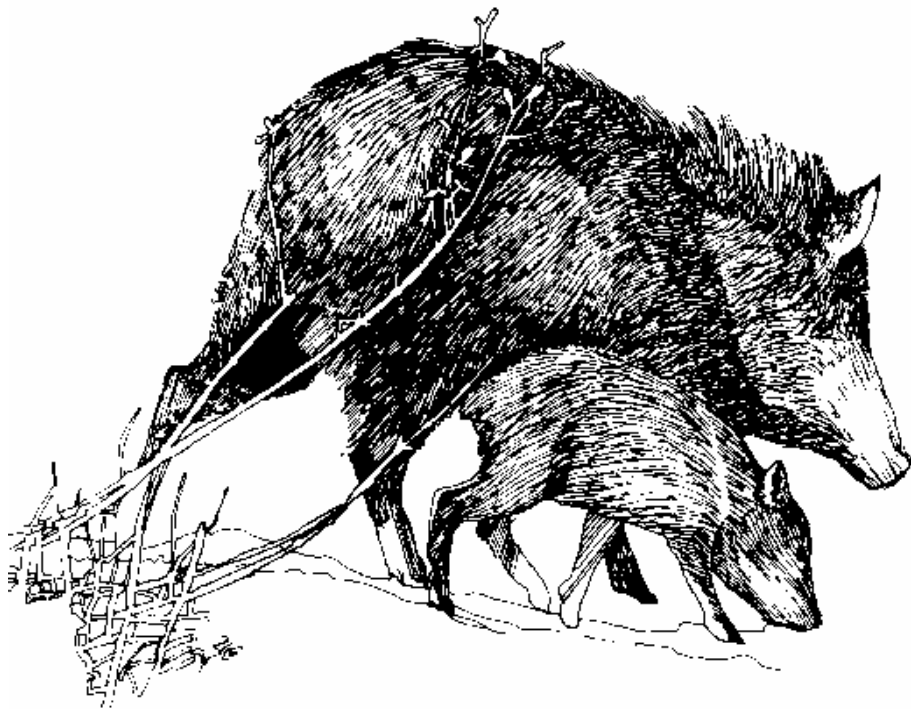

PREDATOR CONTROL

There is no disputing the fact that predators including reptiles, birds, and mammals impact native wildlife populations. Whether that impact is negative or harmful is debated by farmers, ranchers, wildlife professionals and the general public.

Natural systems including predator – prey relationships are complex and evaluating predator impacts on native species may be difficult. Livestock injury and/or loss by predators are measurable with economic consequences and rarely tolerated by ranchers and managers. Loss of wildlife species, such as mule deer preyed upon by mountain lions in West Texas, may not be recognized as readily as livestock losses. But predation on game species may have an economic impact on ranchers through reduced lease revenue or fewer trophy animals.

Landowners and managers of livestock and wildlife should recognize that the goal of predator control should be to protect livestock and minimize losses of native wildlife due to predation, not necessarily maximizing the take of predators.

Landowners and managers must evaluate the need for predator control on their property by assessing the abundance and diversity of predators present, the potential impacts by those predators on desired wildlife species and livestock, and the long-term habitat management goals of the property. For example, removing large predators from high deer density areas will only increase deer populations impacting plant diversity and cover, thus affecting the wildlife species dependant on those plants for food, shelter, and nesting cover.

It may be difficult for landowners new to an area or those not familiar with the needs of wildlife to evaluate the impacts of predators on the resident and migratory species on their property. Wildlife species in Texas have thrived for thousands of years in the presence of native predators (coyotes, bobcats, hawks, etc.), and they possess mechanisms for dealing with annual losses to predators. However, our native wildlife species did not evolve with predators from other continents and often are unable to balance the losses to introduced (non-native) predators. The mere presence of non-native predatory species should prompt an immediate response from the landowner or manager. Feral cats, dogs, and hogs should be removed by whatever means from wildlife habitat and should not be tolerated by owners and managers. Imported red fire ants are another example of a species that should be controlled by every means available.

The Brown-headed Cowbird, a parasitic nester that impacts more than 225 species of birds, should be controlled by trapping when possible and only after attending a certification course given by Texas Parks and Wildlife Department at various times of the year.

Native predator species such as raccoons, ringtails, opossums, skunks, fox, and rat snakes can have localized impacts on resident bird populations especially ground nesting species such as turkey, quail, and a number of songbirds. Control of predators such as these may not need to be a top priority if quality habitat is provided, offering abundant ground and understory cover for shelter, food and nesting.

Coyotes, bobcats, and mountain lions once considered predators of the “wilderness” are now found in close proximity to suburban areas as urban “sprawl” or expansion encroaches on rural farm and ranch lands. As property is developed into this habitat, interaction with these highly

adaptable and mobile species is occurring more frequently. A common sense approach should be taken when considering control of these species. The landowner or manager must evaluate the predicted outcome of control measures prior to starting any control. For example, in many parts of the Edwards Plateau, as well as the State and nationwide, there are too many white-tailed deer and controlling the predators that feed on them would cause increased populations and further loss of habitat for other wildlife species.

Some precautions can be taken when large predators are present in an area close to people. Pets and newborn livestock should be protected by any means available i.e. fencing, enclosures, housing, etc... Keep pet foods from the outdoors and restrict wildlife feeding to a safe and comfortable distance from the house. Maintaining prey abundance (eg., deer harvest) at or below carrying capacity should help to minimize the number of large predators in the area.

If control measures are warranted, consult with a wildlife professional prior to using any measures other than shooting or trapping. Extreme caution should be taken and only the experienced should consider methods such as poisoning.

Some species may not be recognized as predators but cause damage and loss of wildlife by actions other than direct take. For example, European Starlings and English House Sparrows displace native cavity nesting birds such as woodpeckers by taking over and actively defending nest cavities.

The presence of large grackle and blackbird colonies deter other birds from nesting in some areas. Brown-headed and Bronzed Cowbirds have tremendous impacts on songbird populations across the nation. A single female cowbird can lay up to 40 eggs per season, impacting literally hundreds of songbird species including a number of threatened and endangered species in the Edwards Plateau. Trapping and shooting are the most economic means of control, using caution to properly identify species prior to shooting and to release non-target species from traps.

A landowner or manager should first manage the wildlife habitat on his or her property, increasing the plant diversity and abundance of species that provide food, shelter, and nesting cover for all wildlife species prior to implementing a full scale predator control program for all predator species.

For the majority of landowners that feel predator control would be useful in meeting the criteria for H.B. 1358, the bill implemented to allow agricultural appraisal for land used to manage wildlife, a few basic practices will work. The size and location of the property, amount of wildlife habitat, species of predator, and the goals of the landowner will influence the practices used.

Fire ant control and cowbird trapping is not dependant on the criteria above. As well as live trapping of small and medium-sized mammals such as raccoons, opossums, rats, skunks, and others. The control of sparrows, starlings, grackles and feral animals can and should occur on any size property. On larger tracts of land, control of large predators may benefit wildlife present but should be carried out by knowledgeable land managers and/or wildlife professionals when methods other than shooting or live trapping are utilized.

On properties throughout the Trans-Pecos, and across the State, landowners and managers have implemented every known control method for predators and yet they thrive. Landowners need to have a long range wildlife management plan in place defining the goals of any of the

activities occurring on the property including predator control. Once in place, activities can be monitored and results can be recorded to aid in future management decision-making.

Providing Supplemental Water

Marsh and Wetland Restoration or Development
Well, Troughs, Windmill Overflows, and Other Watering Facilities
Spring Development and/or Enhancement

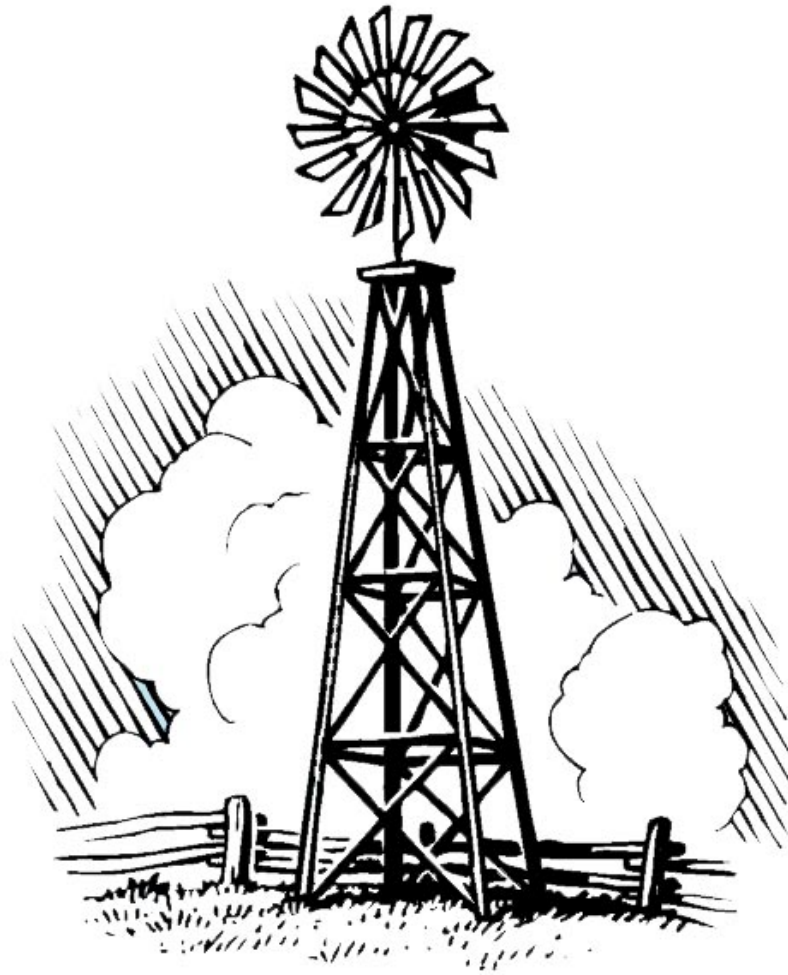

Providing Supplemental Water

Natural water exists in all wildlife environments. Supplemental water is provided when the owner actively provides water in addition to the natural sources. This category of wildlife management activity includes providing supplemental water in habitats where water is limited or redesigning water sources to increase its availability to wildlife. Many people mistakenly believe that water sources suitable for livestock are also suitable for wildlife. Unfortunately, that is not always the case, particularly for young wildlife and many species of birds and small mammals. Wildlife water developments are in addition to those sources already available to livestock and may require protection from livestock.

Marsh or wetland restoration or development can provide supplemental water in the form of shallow wetlands for wetland-dependent wildlife, even in areas where inadequate water does not limit wildlife. Owners may include seasonally available water such as:

- greentree reservoirs;
- specific shallow roost pond development;
- seasonally flooded crops and other areas;
- moist soil management;
- cienega (desert marsh) restoration, development and protection; and
- maintaining water in playa lakes.

Based on wildlife needs and the suitability of the property, managing water levels annually is desirable.

Managing well, trough and windmill overflow can provide supplemental water for wildlife and provide habitat for wetland plants. Owners also may drill wells if necessary and/or build pipelines to distribute water. Building devices—known as wildlife water guzzlers—to collect rainfall and/or runoff for wildlife in areas where water is limited also benefits wildlife, but these devices must be a part of an overall habitat management program.

Spring development and/or improvements can be designed to protect the immediate area surrounding a spring. Excluding and/or controlling livestock around springs may help to maintain native plants and animal diversity. Other ways to protect areas include moving water through a pipe to a low trough or a shallow wildlife water overflow, making water available to livestock and wildlife while preventing degradation of the spring area from trampling.

Improvements also could include restoring a degraded spring by selectively removing appropriate brush and revegetating the area with plants and maintaining the restored spring as a source of wildlife water. Maintaining critical habitat, nesting and roosting areas for wildlife and preventing soil erosion must be considered when planning and implementing brush removal. This practice should be planned and implemented gradually and selectively over a period of time.

Providing Supplemental Food

Grazing Management
Food Plots
Feeders and Mineral Supplementation
Managing Tame Pasture, Old Fields and Croplands
Transition Management of Tame Grass Monocultures



Providing Supplemental Food

Most wildlife environments have many sources of native forages. An owner supplies supplemental food by providing food or nutrition in addition to the level naturally produced on the land.

Food plots are one way to establish locally adapted forage to provide supplemental foods and cover during critical periods of the year. Livestock should be generally excluded from small food plots. The shape, size, location and percentage of total land area devoted to food plots should be based on the requirements of the targeted species.

Feeders and mineral supplements also can help dispense additional food to selected wildlife species during critical periods. These can be as simple as properly placed bird feeders, or more elaborate types of turkey feeders. Once a feeding program has been initiated, it is important to keep it implemented and insure all feeders are kept full. It is also important to clean all feeders regularly to avoid contamination from aflatoxin. Harmful aflatoxin in feed should not exceed 20 parts per billion.

Feeders for deer should not be used except to control excessive numbers of deer and/or exotic ungulates as defined within a comprehensive wildlife management plan with a targeted harvest quota that is regularly measured.

Mineral supplements also may be supplied to wildlife in several ways, however, this practice must be a part of an overall habitat management plan that addresses all animal groups and considers the habitat's carrying capacity.

Managing tame pasture, old fields and croplands can increase plant diversity, provide supplemental food and forage and gradually help convert the land to native vegetation. Recommended practices may include:

- overseeding or planting cool season and/or warm season legumes (for example, clovers, vetches and peas) and/or small grains in pastures or rangeland;
- using plants and planting methods appropriate to the county;
- shallow tillage (discing) that encourages habitat diversity, the production of native grasses and forbs or increases bare ground feeding habitat for selected species; and
- no till or minimum till agricultural practices that leave waste grain and stubble on the soil surface until the next planting season—which provide supplemental food or cover, control erosion and improve soil tilth.

Legumes should be planted annually until all pastures are shifted to native vegetation.

Providing Supplemental Shelter

Nest Boxes
Brush Piles and Slash Retention
Fence-line Management
Hay Meadow, Pasture, and Cropland Management for Wildlife

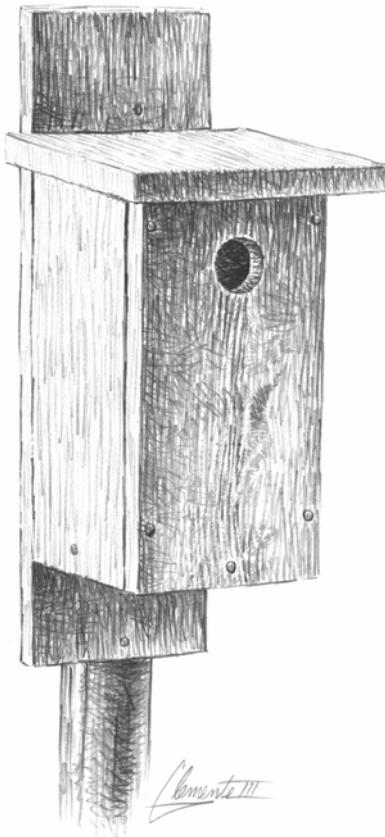

Providing Supplemental Shelter

Cover or shelter is an important part of wildlife habitat. In fact, it is an integral part along side food and water. The arrangements of these key habitat requirements (often called juxtaposition) will often determine the success of wildlife species in a given area. Wildlife cover can take many forms and can vary greatly from one species of wildlife to another. Some species of wildlife are very specific in their need for cover while other are quite opportunistic and can readily adapt to what's available. However, one thing is common when it comes to cover; they all require it.

Although supplemental shelter can be provided in many ways, it will never take the place of good conservation and management of native habitats. When land is properly managed for wildlife habitat, quality cover and shelter will usually be available. Unfortunately in much of Texas, many areas have been so altered, neglected, and abused that one or more of the key requirements of wildlife (including shelter) is absent or in short supply. This is where the opportunity exists for supplementation.

Before beginning on any wildlife management practice, you must determine what wildlife species you are managing for and what its specific needs are. Some need cover on a large scale while others may need a relatively small amount of cover. Some live and reproduce exclusively on the ground while others spend most of their lives in the air or in trees. Management should be targeted to those populations of wildlife in your area and their specific needs.

Cover and shelter can be provided for wildlife in many ways. Some species of birds and mammals nest and reproduce in cavities. Nest boxes and "snags" (dead, standing trees) can be created for these wildlife species. Brush piles can be created to provide cover for many species of birds, reptiles, and small mammals. Other properties lack cover on a larger scale impacting larger wildlife species such as white-tailed deer. Trees and shrubs can be planted to provide this cover requirement. Mowing can be deferred in certain areas to let grasses and weeds (forbs) grow up providing both food, cover and nesting sites for some species of wildlife. Reduced stocking rates or grazing deferment will help develop supplemental food and supplemental shelter in the form of fawning cover and nesting cover. Fence lines can be allowed or encouraged to grow up in trees, shrubs, and vines in areas where cover is limited. Mesquite or other brush can be half cut early in the growing season on provide low growing, ground cover in areas where this is lacking

Census

Spotlight Counts
Standardized Incidental Observations
Stand Counts of Deer
Aerial Counts
Track Counts
Daylight Deer Herd and Wildlife Composition Counts
Harvest data Collection and Record Keeping
Browse Utilization Surveys
Census of Endangered, Threatened, or Protected Species
Census and Monitoring of Nongame Wildlife Species
Miscellaneous Counts

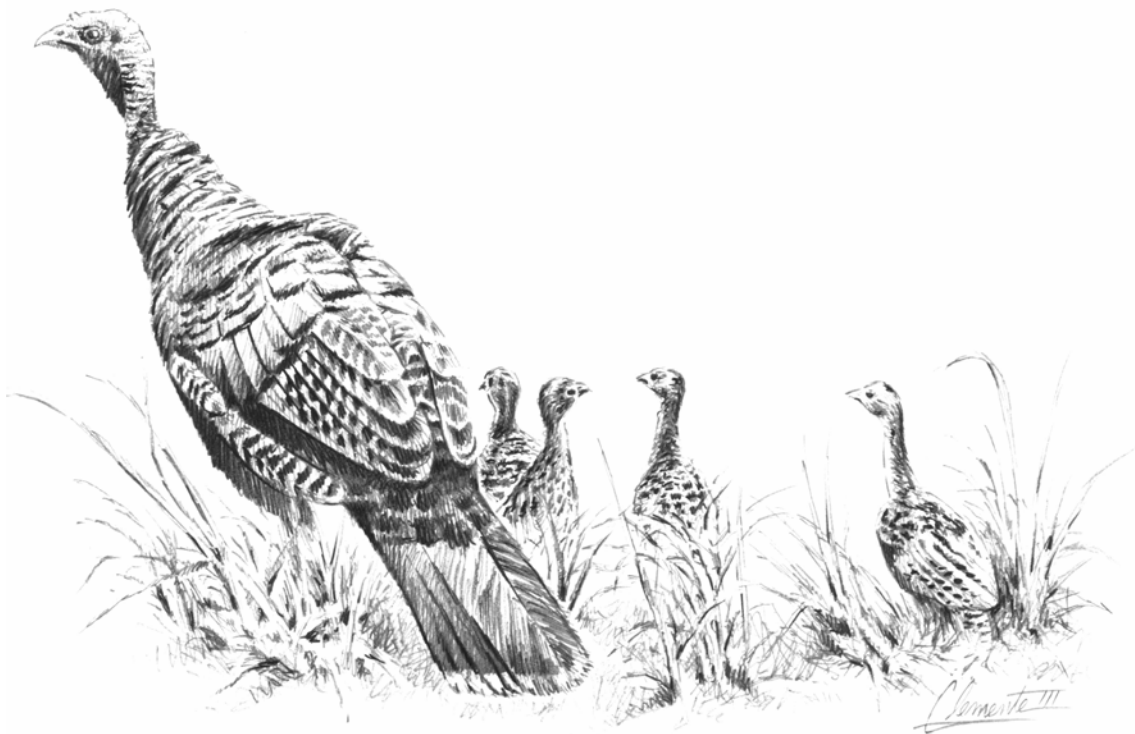

Census

Census counts are periodic surveys and inventories to determine the number, composition or other relevant information about a wildlife population to measure if the current wildlife management practices are serving the targeted species. Such surveys also help evaluate progress toward the goals described in your management plan. Specifically, this activity estimates species numbers, annual population trends, density or age structure using accepted survey techniques. Annual results should be recorded as evidence of completing this practice.

Spotlight counting animals at night along a predetermined route using a spotlight should follow accepted methodology, with a minimum of three counts conducted annually.

Aerial counts using a fixed-wing aircraft or helicopter to count animals also should follow accepted methodology for the region and be performed by a trained individual.

Daylight wildlife composition counts are driving counts used to census wildlife in daylight hours. Annual population trends on dove, quail, turkey and deer, as well as sex/age structure on deer, should be determined by sightings along a standardized transect of a minimum of five miles at least three times during a season.

Harvest data collection/record keeping means tracking annual production of wildlife. Age, weight and antler development from harvested deer, and the age and sex information from game birds and waterfowl should be obtained annually.

Browse utilization surveys annually examine deer browse plant species for evidence of deer use on each major vegetative site on the property. The surveys should be conducted in a way that can be repeated.

Census and monitoring of endangered, threatened or protected wildlife through periodic counts can improve management and increase knowledge of the local, regional or state status of the species.

Census and monitoring of nongame wildlife species also can improve management or increase knowledge of the local, regional or state status of the species. These practices can include developing checklists of wildlife diversity on the property and should be a part of a comprehensive wildlife management plan.

One of the most important things for a landowner to remember when designing a census protocol of nongame species on their property is the ability to be consistent. In other words, be able to do the same thing in the same way at the same time each and every time the census is conducted.

APPENDICES

STANDARD WILDLIFE HABITAT AND POPULATION MANAGEMENT RECOMMENDATIONS

For the

TRANS-PECOS
ECOLOGICAL REGION

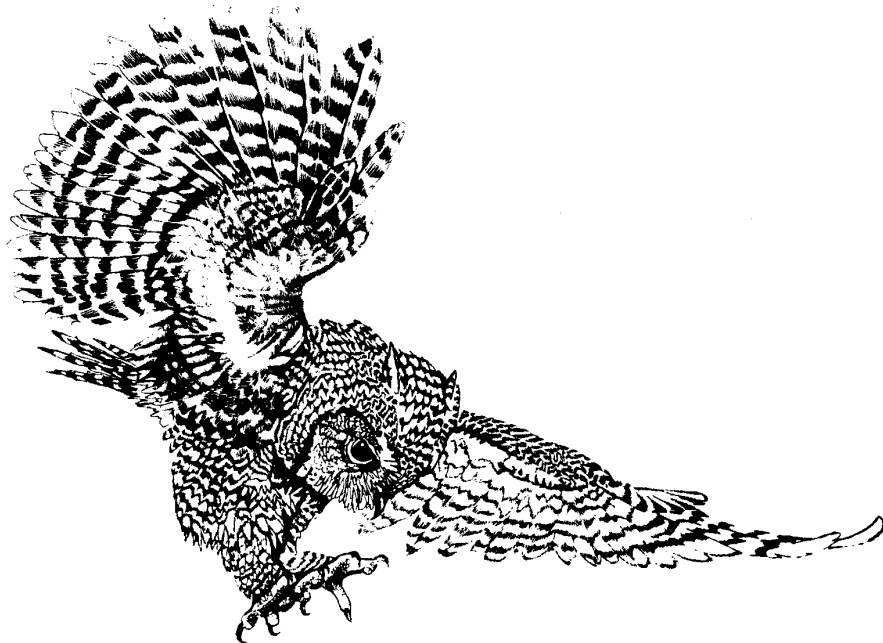

Appendix A

General Habitat Management Considerations, Recommendations, and Intensity Levels

Fundamental requirements which must be considered when managing wildlife habitat include food, cover, water and the proper distribution of these elements.

Wildlife and habitat management should be directed at maintaining a productive and healthy ecosystem. The ecosystem consists of the plant and animal communities found in an area along with soil, air, water and sunlight. All management activities should be aimed at conserving and improving the quantity and quality of soils, water and vegetation.

Managing for plant diversity is essential. A diverse habitat has a good mixture of various species of grasses, forbs (weeds), and browse (woody) plants. Many of these plants will be at various stages of growth, which adds another element of diversity. The diversity of vegetation increases the availability of food and cover for wildlife species. A greater diversity of plants results in more food being made available during different periods of the year. The volume and diversity of plants protects the soil from erosion. Also, the decomposition of vegetation helps restore needed minerals to the soil to sustain plant life. Vegetation improves the water cycle by increasing water infiltration into the soil and reducing surface runoff.

An ecologically based habitat management program serves to improve water cycling, mineral cycling, and energy flow and manipulate plant succession. These processes enhance vegetative quantity, quality and diversity. A greater diversity of all life forms, including microorganisms, insects, reptiles, amphibians, birds and mammals may be achieved under sound management. The land's long term health is improved and conserved for future generations to utilize as a source of income, recreation and for aesthetic enjoyment.

Plant communities with a diversity of grasses and native broad-leaved weeds (called forbs) are more productive than those comprised primarily of grasses. The climax plant community of most rangelands is comprised primarily of perennial grasses with a relatively low forb component. While this may be suitable for livestock and some grassland wildlife, most species are dependent on the seeds and foliage of forbs. Periodic disturbances such as fire, livestock grazing, mowing, and soil disturbance (disking, ripping, aeration) can set back plant succession and maintain a diverse plant community, simulating conditions under which plants and animals evolved within ecosystems in Texas.

Below is an example of a plan format that many landowners in the Trans-Pecos may find applicable to their property, depending on their particular goals and objectives. A fill-in-the-blank plan following this format is attached in Appendix Y. This is presented to help landowners develop a Wildlife and Habitat Management Plan. To meet the

requirements of the wildlife management tax valuation, a landowner must annually implement and complete at least one management ACTIVITY from at least three of the seven wildlife management PRACTICES (i.e. Habitat Control, Erosion Control, Predator Control, Providing Supplemental Supplies of Water, Providing Supplemental Supplies of Food, Providing Shelter, and Making Census Counts to Determine Population). Again, a complete plan will likely include more than three activities, and may include several practices under each activity.

It is important for the landowner to be able to document the wildlife management activities that have taken place during the tax year. Receipts, photographs, and maps are some of the types of documentation a landowner might want to consider using for this purpose. If requested to do so by the county, the landowner may have to file an annual report, including documentation, on management activities undertaken during the year. The required fill-in-the-blank report form is attached in **Appendix Y**.

Wildlife and Habitat Management Plan

General Information

Tract Name: _____	County: _____
Owner: _____	Manager: _____
Address: _____	Address: _____
Address: _____	Address: _____
Phone: _____	Phone: _____
Phone: _____	Phone: _____
Individual Preparing the Plan: _____	
Date: _____	

Is property leased for hunting? Yes No
Consultation is with: Owner Lessee Manager
Location of Property: Distance and direction from nearest town

Is acreage under high fence? Yes No

Acreage:

Cropland:	Non-native Pasture:
Non-Native Grass Pasture:	Native Mixed-Brush Rangeland
Native Grass Rangeland:	Wetlands(optional):
Ponds/Lakes:	Other(specify):

Total Acres:

Current Habitat Description:

Describe vegetation associations or types (eg., Pinyon-Juniper woodland, Oak-Juniper woodland, Chihuahuan Scrub, High-Desert Grassland). State dominant plants occurring and/or crops grown on the property. The description can include the soil types and vegetation associated with the various soil types. Describe livestock and wildlife water sources (eg., permanent or seasonal streams, springs, stock tanks, water troughs) that are present. Documentation may include any NRCS, TPWD, or other plan, map or aerial photo that may exist for the tract to identify soils, vegetation and water sources. The plant list should include browse plants utilized by deer, if deer management is a goal (see appendices G and H). Also, state the degree of use on key browse plants utilized by livestock and deer:

Past History of Land Use and Wildlife:

Describe past land use practices that have been implemented such as prescribed burns, range or pasture reseeding, brush management, etc. Describe past history of cropping, livestock, and wildlife management (census, harvest, etc.). Present other biological information such as the presence of unique cover types, turkey roosts, feral hogs or other exotic big game that compete with native wildlife, et cetera.

Goals and Objectives:

A discussion and outline of landowner (also family if desired) goals and objectives for the property is necessary to define direction and to realistically assess the set of activities and practices that should be incorporated to integrate wildlife and habitat enhancement.

(Select one or more to guide the wildlife and habitat planning process)

1. Improve habitat for native game species (as designated in the Texas Outdoor Annual).
2. Improve habitat for native nongame species (those species not listed as game species, e.g. songbirds).
3. Manage for habitat and wildlife diversity.

4. Restore, maintain or improve native habitats for wildlife diversity.

5. Generate revenue from native wildlife resources.

6. Improve habitat for rare native species.

7. Protect sensitive habitats or critical species.

8. _____

9. _____

10. _____

11. _____

12. _____

Management Practices Normally Beneficial for Representative Wildlife in the Trans-Pecos Ecoregion	Mule Deer	White-tailed Deer	Pronghorn Antelope	Wild Turkey	Scaled Quail	Mourning Dove	Javelina	Red-Tailed Hawk	Curve-billed Thrasher	Black Bear	Desert Cottontail	Big Bend Slider
A. HABITAT CONTROL												
Grazing Management	X	X	X	X	X	X	X	X	X	X	X	X
Prescribed Burning	X	X	X	X	X	X	X	X	X	X	X	X
Range Enhancement (Reseeding)	X	X	X	X	X	X		X		X	X	X
Brush Management	X	X	X	X	X	X	X	X	X	X	X	
Fence Modification			X									
Riparian Management / Enhancement	X	X		X		X		X	X	X	X	X
Wetland Enhancement	X	X						X			X	X
Habitat Protection-Species of Concern										X		X
Prescribed Control-Native,Exotic,Feral Species	X	X	X	X	X		X				X	X
Wildlife Restoration	X	X	X	X								
B. EROSION CONTROL												
Pond Construction	X	X	X	X	X	X	X				X	X
Gully Shaping												
Streamside, Pond, Wetland Revegetation	X	X		X							X	X
Herbaceous &/or Woody Plant Establishment	X	X	X	X	X	X	X		X	X	X	
Dike / Levee Construction / Management				X	X						X	
Establish Water Diversion												X
C. PREDATOR CONTROL												
Predator Management	X	X	X	X	X						X	
Control of Brown-headed Cowbirds						X						
Grackle / Starling / House Sparrow Control						X						
D. PROVIDING SUPPLEMENTAL WATER												
Marsh / Wetland Restoration												X
Well/Trough/Windmill Overflow	X	X	X	X	X	X	X				X	
Fence Modification			X									
Spring Development &/or Enhancement	X	X	X	X			X			X		
E. PROVIDING SUPPLEMENTAL FOOD												
Grazing Management	X	X	X	X	X	X	X	X	X	X	X	X
Prescribed Burning	X	X	X	X	X	X	X	X	X	X	X	
Range Enhancement	X	X	X	X	X	X	X	X		X	X	
Fence Modification			X									
Food Plots	X	X	X	X	X	X					X	
Feeders & Mineral Supplementation	X	X		X	X							
Managing Tame Pasture, Old Fields, Croplands	X	X	X	X	X	X		X			X	
F. PROVIDING SUPPLEMENTAL SHELTER												
Nest Boxes, Bat Boxes												
Brush Piles & Slash Retention					X			X	X		X	
Fence Line Management				X	X	X	X	X	X		X	
Cropland Management	X	X	X	X	X	X					X	
Half Cutting Trees & Shrubs					X						X	
Woody Plant / Shrub Establishment	X	X			X		X		X	X	X	
Natural Cavity / Snag Development								X				
G. CENSUS												
Spotlight Counts	X	X										
Aerial Counts	X	X	X		X		X					
Daylight Deer Herd / Wildlife Composition Counts	X	X	X									
Harvest Data / Record Keeping	X	X	X	X	X							
Browse Utilization Survey	X	X	X									
Census & Monitoring of Endangered/Threatened										X		X
Census & Monitoring of Nongame Species								X	X		X	
Miscellaneous Counts				X	X						X	

Specific Habitat Management Practices, By Activity

HABITAT CONTROL

GRAZING MANAGEMENT

(Refer to Appendix D - Livestock Recommendations, for information to help prepare a specific grazing proposal for the plan.)



Grazing management, which may include deferment, is the planned manipulation of livestock numbers and grazing intensities to increase food, cover, or improve structure in the habitat of selected species.

Grazing management includes: 1) kind and class of livestock grazed, 2) determination and adjustment of stocking rates, 3) implementation of a grazing system that provides planned periodic rest for pastures by

controlling grazing intensity and duration, and/or 4) excluding livestock from sensitive areas to prevent trampling, allow for vegetative recovery, or eliminate competition for food and cover. Planned deferments can be short or long term up to 2 years. Extended rest from grazing (two years or more, if necessary) may be required on some ranges. Seasonal stocker operations may be appropriate to manipulate habitat. Supplemental livestock water (earthen tanks, troughs, wells, piping) to facilitate deferred-rotation grazing of livestock and disperse grazing pressure may be incorporated into planning to improve wildlife habitat. Similarly, it is important to plan and design fence construction to facilitate deferred-rotation grazing of livestock. Fencing can also be used to enhance or protect sensitive areas, woodlands, wetlands, riparian areas and spring sites as designated in plan. Activities should be reviewed annually.

Grazing management systems might include:

- 1 Herd / 3 Pasture (preferably as a step in moving toward a 1 herd / multiple pasture {4+} grazing system)
- 1 Herd / 4 Pasture
- 1 Herd / multiple pasture multiple herd / multiple pasture (goal is to move toward always resting 75% of area)
- High intensity/low frequency (HILF)
- Short duration system

- Other type of grazing system (ex. a short-term stocker system):
- Planned Deferment (e.g., number of years livestock will be deferred from the property, etc.):

PRESCRIBED BURNING

(Refer to Appendix E - Vegetation Management Recommendations, for information to help prepare a specific burning proposal for the plan.)

Prescribed burning is the planned application of fire to improve habitat quality by reducing woody vegetation and increasing plant diversity. Plans should indicate a minimum percent of acreage and general burning cycle (**eg., an 8 to 15 year burning cycle in the Trans-Pecos so that approximately 10% of the designated area is scheduled for burning each year**). Attach a written burning plan as an addendum to the Wildlife and Habitat Management Plan (burn plans and prescribed burning should only be attempted with aid of professionals). The plan should include a map that shows the areas to be burned and the planned dates (month and year) that each area will be burned during the burning cycle. It should also designate areas to be protected from burning, and should incorporate flexibility during periods/ years when conditions are not favorable. Specific areas (eg., sensitive sites) to be protected from burning should be briefly described and shown on a map.



RANGE ENHANCEMENT (Range Reseeding)

Establish native herbaceous plants (grasses and forbs) that provide food and cover for wildlife or erosion control benefits. Plant species selected and methods for establishment should be applicable to the county. Seeding mixtures providing maximum native plant diversity are recommended. Many herbaceous broadleaf plants (known as forbs, weeds, or wildflowers) are beneficial to wildlife for forage and/or seed production. Encourage "weed and wildflower" species by selective application of chemical, biological (eg.,



grazing management) and/or mechanical means on native rangelands, Conservation Reserve Program lands, and tame grass pastures (eg., coastal bermuda, Old World bluestem, etc.). Some periodic weed control may be needed in fields converted to native rangeland to assist in the establishment of desirable vegetation (see Appendix U). This practice must be a part of an overall habitat management plan and designed to reestablish native habitats within a specified time frame. **Range Enhancement should annually affect a minimum of 10% of the total area designated in the plan, or a minimum of 20 acres annually, whichever is less, until the project is completed.**

BRUSH MANAGEMENT

(Refer to Appendix E - Vegetation Management Recommendations, for information to help prepare a specific brush management proposal for the plan.)



Removal of salt cedar through precision aerial application of herbicide can increase plant diversity, enhance habitat for wildlife and help restore instream water flow.

Brush management may be the removal or establishment of woody plants.

It can be the selective removal or suppression of target woody species, including exotics, to allow the increased production of desirable trees, shrubs, grasses, and forbs for forage and nesting or protective cover for selected species.

Brush Management practices should annually affect a minimum of 10% of the total area designated in the plan, or a minimum of 100 acres annually, whichever is smaller. This practice includes retaining the proper kind, amount, and distribution of

woody cover for selected species. Brush management planning must consider wildlife cover requirements, soil types, slope angle and direction, soil loss and erosion factors, and subsequent planning to control re-invasion. This practice also includes retention of snags to provide cover and nesting sites for cavity nesting animals. When used, herbicides should be applied in strict accordance with label directions.

This practice can include **the planting of a minimum of 50 native plants (trees and/or shrubs) per year for the area designated in the plan** to provide food, corridors and/or shelter using species and methods applicable to the region. In areas virtually devoid of woody cover, a practice that is beneficial to quail, songbirds, and other species that use low-growth woody cover involves the establishment of irregular mottes (clumps) of shrubs one-tenth of an acre in size. Mottes should contain approximately 30 seedlings (i.e., skunkbush sumac, littleleaf sumac, four-winged saltbush, prickly pear, catclaw acacia, condalia spp.) at a spacing of about 12' between seedlings to allow for crown development at maturity. Establish a minimum of one planting per 2 acres in areas devoid of woody cover or a minimum of one planting per 5 acres in areas where woody cover exists but is considered insufficient. For most sites

in the Trans Pecos, irrigation of woody plantings is necessary for the first 3-5 years to improve survival. **Woody plant establishment should annually affect a minimum of 10% of the acreage designated in the plan or a minimum of 5 acres annually, whichever is less.**

VEGETATION SURVEYS

Annually survey vegetation transects (normally fall or spring) and identify grass, forb and woody species to evaluate the impact of management practices on range condition and range condition trend. This practice can provide important information regarding changes in habitat quality over time. **A minimum of five, 300-foot permanent transects are required for each major vegetative type.** Surveys should be conducted using standard methodology to identify 100 plants per transect (i.e., identify a plant every 3 feet along the transect line).

FENCE MODIFICATION

Modify net-wire or “sheep-tight” barbed-wire fences to allow free movement of pronghorn antelope and/or bighorn sheep. Pronghorn antelope and bighorn sheep will



rarely jump over fences; therefore, net-wire and sheep-tight barbed wire fences often serve as effective barriers to movement. However, antelope and bighorn sheep can easily negotiate 4-strand, barbed-wire fences by crawling under or through the wires. The long-term survival of antelope and bighorn herds is dependent on their ability to move long distances on a seasonal basis to find the best habitat conditions available, especially as conditions relate to forage quantity and quality.

Long-distance movements also may be necessary to access a remnant water source during drought. In addition, individuals may be more susceptible to predation when they venture near these barrier-type fences. This is particularly true for antelope fawns (see Appendix K).

This practice can include the development of “gaps” in the fence by folding up the lower portion of sheep-netting and stapling it in place, such that a 16-18” space is created between the wire and the ground. This practice can also include replacing sections of net-wire with 4-strand barbed wire, or replacing entire net-wire fences with barbed wire. The bottom wire should be located 16-18” above the ground. The greater the freedom of movement for antelope and bighorn herds, the better their chances for long-term survival. **The minimum intensity of this practice to qualify is a 100-yard gap installed for every ½ mile of net-wire fence that exists within the range of the target species. A fence modification project will qualify for 5 years, and a**

minimum of 20% of the designated fencing must be modified annually.

RIPARIAN MANAGEMENT AND ENHANCEMENT

Annually and seasonally protect the vegetation and soils in riparian areas (low areas on either side of stream courses) from mismanagement, such as caused by excessive, long-term livestock trampling. Riparian management and enhancement can include providing livestock with alternate watering sites, deferring livestock grazing in pastures with riparian areas during critical periods of the year, total exclusion of livestock from pastures with riparian areas, and fencing riparian areas to exclude or provide short duration grazing by livestock. Establish trees, shrubs, or herbaceous vegetation along streams or water courses to provide food, cover, and travel corridors, and to reduce erosion. Corridors should be at least 100 yards wide. Refer to “Agroforestry Notes - A Riparian Buffer Design for Cropland” (AF Notes-5, January 1997) by the U.S. Forest Service that gives details for establishing a 50 ft. wide strip of grass, shrubs, and trees between a stream and cropland. Restore important forested habitats including bottomland hardwoods and turkey roost sites. **A minimum of one Riparian Management and Enhancement project must be implemented and maintained every 10 years to qualify.** See Appendix E.

Proposed riparian management and enhancement projects might include:

- Fencing
 - complete fencing of riparian areas
 - partial fencing of riparian areas
- Deferment from livestock grazing
 - complete deferment
 - periodic deferment.
- Establish vegetation
 - trees
 - shrubs
 - herbaceous
 - both sides of stream
 - one side only

WETLAND ENHANCEMENT

Annually provide seasonal or permanent water for roosting, feeding, or nesting habitat for wetland wildlife. This practice involves shallow wetland management, creation or restoration, and other moist soil management such as rotational grazing or exclusion (fencing out) of livestock from wetlands, especially during the growing season. Selective herbicide



Over 50% of Texas' wetlands have disappeared. Wetland management, restoration or creation is extremely important for wetland dependent wildlife.

applications may be necessary for control of problem wetland vegetation. Annual management as described in management plan, such as water level manipulation qualifies. **Construction and maintenance of a new project will qualify for 10 years.**

HABITAT PROTECTION FOR SPECIES OF CONCERN



Planned protection and management of land or a portion of land to provide habitat for an endangered, threatened or rare species, such as fencing off critical areas, managing vegetation structure and diversity within species parameters, establishing and maintaining firebreaks to protect critical overstory vegetation, and annually monitoring the species of concern. This practice includes the management/protection of nesting sites, feeding areas, and other critical habitat limiting factors, and the development of additional areas.

The broad-scale management of habitat for migrating/wintering/ breeding neotropical birds (primarily songbirds) should follow guidelines in appendix for zones of importance. Refer to Appendix T for guidelines on the management of habitat for the black-capped vireo which occurs in certain oak-juniper woodlands in the Trans-Pecos Ecological Region. **A minimum of one project must be implemented every 10 years to qualify.**

Proposed projects for habitat protection for species of concerns might include:

- Planned protection/management projects:
- fencing
- firebreaks
- prescribed burning
- habitat manipulation (e.g. thinning, etc.)
- control of nest parasites
- native/exotic ungulate control
- other _____

PRESCRIBED CONTROL OF NATIVE, EXOTIC AND FERAL SPECIES

Use legal means to control the number of grazing and browsing animals. Maintain the population density of native wildlife (particularly white-tailed deer — see Appendix F) at the carrying capacity of the habitat to prevent overuse of desirable plant species and enhance habitat for native wildlife species. Exotic species and feral animals should be strictly controlled to minimize negative impact on native wildlife and habitat. This should incorporate harvest and vegetative monitoring over time to assess control intensity and impact on habitat to meet plan objectives. **Removal intensity should be documented as to species, number, control method, and date.**

Remove or control exotic vegetation impacting native habitats and wildlife populations (eg. large stands of naturalized saltcedar, etc.). Convert non-native grass pastures (such as large areas of coastal bermuda, kleingrass, old world bluestem) to native

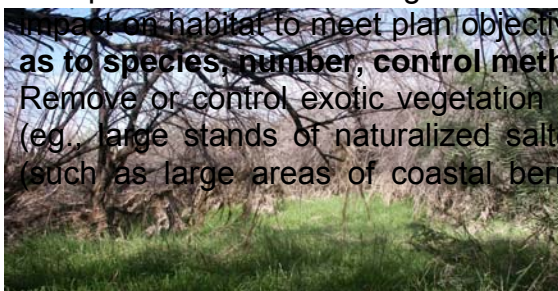

Removal of salt cedar helps increase plant diversity, enhance habitat for wildlife and helps restore instream water flow.

vegetation. **The removal or control of exotic vegetation or the conversion of non-native grass pastures must affect a minimum of 10% of the non-native vegetation on the property or 20 acres annually, whichever is less.**

WILDLIFE RESTORATION

Restoration or enhancement of habitat to good condition for target species, and reintroduction and population management of TPWD approved native species within the carrying capacity of the habitat as part of an approved restoration area at a scale capable of supporting a sustainable population (eg., pronghorn antelope, bighorn sheep, Mearns' quail).



EROSION CONTROL

POND CONSTRUCTION AND MAJOR REPAIR

Construction or major repair of a permanent water pond for the purpose of preventing, stopping, or controlling erosion, such as being part of an approved NRCS erosion control structure. The project must provide habitat diversity and wildlife benefits. Creation/restoration of shallow water areas as primary production wetlands, and associated water level control and management, should be associated with ponds at every opportunity. **A minimum of one project must be implemented and maintained every 10 years to qualify.**

STREAMSIDE, POND, AND WETLAND REVEGETATION

Re-vegetating areas along creeks, streams, ponds, and wetlands to reduce erosion and sedimentation, stabilize stream banks, improve plant diversity, and improve wildlife value of sensitive areas. This practice can include: (a) the construction of permanent or temporary fences to exclude, limit, or seasonally graze livestock; (b) the use of native hay to slow and spread water runoff, in areas where vegetation has been recently reestablished (seeds in the hay aid in re-vegetation); (c) establishing vegetative buffer areas or filter strips along water courses or other runoff areas; (d) establishment of 3:1 upland buffer to lake basin/wetland acreage in diverse grass/legume/forb mixture to prevent sedimentation; (e) the installation of rip-rap, dredge spoil, or other barrier material - placement of material along erodible embankments to prevent erosion and protect wildlife habitat; (f) the establishment of stream crossings to provide permanent low water crossings in order to reduce or prevent erosion. **A minimum of one project must be completed and maintained every 5 years, affecting a minimum of 2 acres**

per project.

Proposed streamside, pond, and wetland restoration project(s) may include the following techniques:

- native shrub and tree plantings
- native hay bales
- fencing
- filter strips
- seeding upland buffer
- rip-rap, etc.
- stream crossings



A flashboard riser box attaches to a pipe installed in a levee to create a shallow water wetland for wildlife.

PLANT ESTABLISHMENT ON CRITICAL AREAS (erodible)

Primarily for erosion control, the establishment of native woody or herbaceous vegetation can also provide food and/or cover for wildlife and restore native habitat. This practice can include: (a) establish and manage wind breaks/shelter-belts by planting multi-row shelter-belts, renovate old shelter-belts (re-fence, root-prune, and replace dead trees), and establish shrub mottes, improve plant diversity, and improve wildlife habitat; (b) establish perennial vegetation on terraces and field borders (30 yard minimum width) to reduce erosion, improve plant diversity, and improve wildlife habitat; (c) conservation tillage/no-till farming practices by leaving waste grain and stubble on the soil surface until the next planting season to provide supplemental food or cover for wildlife, control erosion, and improve the soil tilth; (d) manage Conservation Reserve Program cover by maintaining perennial cover established under the Conservation Reservation Program (expired contracts) on erodible sites using proper management techniques such as haying, prescribed grazing or prescribed burning. **A minimum of 50 seedlings per acre must be planted annually on 5 acres or a minimum of 10%, whichever is smaller, of the total designated area treated annually.**

DIKE/LEVEE CONSTRUCTION/MANAGEMENT

To establish/maintain wetlands or slow runoff to control or prevent erosion, and to provide habitat for wetland dependent wildlife. Levee management may include reshaping or repairing damage caused by erosion, and re-vegetating levee areas to reduce erosion and sedimentation, and stabilize levees. This practice may include fencing to control and manage grazing use, or installation of water control structures. **A minimum of one project must be completed and maintained every 10 years.**

ESTABLISH WATER DIVERSION

Install water diversion systems that will protect erodible soils and divert water into wetlands to provide habitat for resident and migratory water birds and wetland dependent species. Seed diversion areas to species tolerant of seasonally standing

water. **A minimum of one project must be completed and maintained every 10 years.**

PREDATOR CONTROL

PREDATOR MANAGEMENT

The management of predator populations to increase survival of target species. Key native predator species may include coyote, raccoon, bobcat, mountain lion, and rat snakes, while exotic predators may include feral house cat, feral dog, and feral hogs (see imported red fire ants in separate paragraph). Predator Control alone will not be an applicable practice unless it is part of an overall plan to manage the habitats and populations of the target species. Texas Parks and Wildlife Department advocates elimination of feral/exotic predators, with the thoughtful management of native predators as an integral part of functioning natural systems. **The predator control plan should be prepared or approved by a competent professional and include intended method(s), duration and intensity of control to annually manage the target species.**

IMPORTED RED FIRE ANT CONTROL

To protect native wildlife species or their food base, including native fire ants which seem to restrict the spread of the imported fire ants. **Proper treatment of at least 10 acres or 10% of infested area per year, whichever is more.** Treatment will comply with pesticide label instructions, and information is available in Appendix P and on the internet at <http://fire ant.tamu.edu>



CONTROL OF COWBIRDS

Reducing populations of these birds for the purpose of decreasing nest parasitism of target neotropical bird species (eg. endangered Black-capped Vireos and other songbirds) in a PLANNED PROGRAM (see Appendix S, T, and W). **Removal of at least 30 cowbirds annually is required to qualify.**

GRACKLE/STARLING/HOUSE SPARROWS CONTROL

Reducing populations of grackles and/or starlings and/or house sparrows for the purpose of controlling avian diseases and reducing overcrowding to exclusion of other avian fauna in a planned program particularly targeting white-winged dove and other neotropical birds. **Removal of at least 30 grackles/starlings/house sparrows annually is required to qualify.**

Proposed Grackle/Starling/House Sparrow Control Project(s) may include:

- trapping
- shooting
- scare tactics

PROVIDING SUPPLEMENTAL WATER

* This category includes providing supplemental sources of water specifically for wildlife in habitats where water is limited. Wildlife water developments are in addition to those sources already available to livestock and may require protection from livestock.

FENCE MODIFICATION

This practice is identical to Fence Modification in Habitat Control Activity. Refer to Fence Modification in Activity A for information to prepare a specific fence modification proposal for the plan under this Activity. This practice can not qualify under more than one Activity.

MARSH/CIENEGA/WETLAND RESTORATION OR DEVELOPMENT

Provide supplemental water in the form of shallow wetlands for wetland dependent wildlife. Applicable even in areas where water is not a critical limiting factor for upland species of wildlife. May include specific shallow roost pond development, seasonally flooded crops and other areas, artificially created wetlands, marsh restoration-development-protection, and moist soil management. Based on wildlife needs and suitability of the property, the annual manipulation with control structures is desirable.

The minimum requirement to qualify under this practice is one marsh/wetland restoration or development project every 5 years; or the annual manipulation of water (flooding and draw-down) on a marsh, cienega, or other wetland. Call for TPWD OR NRCS for professional assistance when creating/enhancing wetlands.

**WELL, TROUGHS,
WINDMILL OVERFLOW,
AND OTHER WILDLIFE
WATERING FACILITIES**





Designing and implementing watering systems that provide supplemental water for wildlife and promote wetland plants. This practice may include modifying existing water systems to make water more accessible to wildlife (eg., fenced windmill overflows for exclusive use by wildlife, constructing ramps to improve access and escape for birds and small mammals). This practice may also include drilling wells, if necessary, and/or constructing

pipelines to distribute water and/or divert water to specialized wildlife watering facilities. At least one watering site per 2,500 acres is generally adequate for most mule deer populations; however, a watering site per 640 acres or less will normally improve the distribution and abundance of a variety of wildlife species. **A minimum of one project per 5 years must be completed to qualify; or the consistent management and maintenance of watering sites specifically for wildlife benefits.**

Proposed Well/Troughs/Windmill Overflow/Other Wildlife Watering Facility Project(s) may include: (see Appendix O):

- Drill new well:
 - windmill
 - pump
 - pipeline
- Modification(s) of existing water source:
 - fencing
 - overflow
 - trough modification
 - pipeline
- Distance between water sources {waters} _____

- Type of Wildlife Watering Facility
 - PVC/Quickline/Other Pipe Facility
 - Drum with Faucet or Float
 - Small Game Guzzler
 - Windmill Supply Pipe Dripper
 - Plastic Container
 - In-ground Bowl Trough
 - Big Game Guzzler
 - Inverted Umbrella Guzzler
 - Flying Saucer Guzzler
 - Ranch Specialties Wildlife Guzzler

- Other _____

Capacity of Water Facility(ies): _____

SPRING DEVELOPMENT AND/OR ENHANCEMENT

Implementing methods designed to protect the immediate area surrounding a spring. This practice may include excluding and/or controlling livestock around springs to maintain native plant and animal diversity and/or moving water through a pipe to a low trough or shallow wildlife water overflow, making water available to livestock and wildlife while preventing degradation of the spring area from trampling and other animal impacts. It may also include restoring a degraded spring by the judicious removal of dense brush (possibly over a period of years) and the revegetation of drainages and canyons with herbaceous plants, and maintaining the restored spring as a source of wildlife water. Important considerations when planning and implementing brush removal are preventing soil loss and erosion and maintaining critical habitat, as well as nesting and roosting areas for wildlife. **A minimum of one project per 5 years must be completed to qualify, or the consistent management and maintenance of existing or restored springs to prevent degradation.**

Proposed Spring Development and/or Enhancement Project(s) may include the following:

- Fencing
- Water diversion/pipeline
- Brush removal
- Spring clean out
- Ponds, stock tanks, water impoundments (see stock ponds, tanks, lakes)

PROVIDING SUPPLEMENTAL FOOD

GRAZING MANAGEMENT

(This is identical to Grazing Management in Activity A. Refer to Grazing Management in Activity A for information to prepare a specific grazing proposal for the plan under this Activity).

PRESCRIBED BURNING

(This is identical to Burning Prescribed in Activity A. Refer to Prescribed Burning in Activity A for information to prepare a specific burning proposal for the plan under this Activity)

RANGE ENHANCEMENT (Range Re-Seeding)

(This is identical to Range Enhancement (Reseeding) in Activity A. Refer to Range Enhancement (Range Reseeding) in Activity A for information to prepare a specific range enhancement proposal for the plan under this Activity)

FENCE MODIFICATION

This practice is identical to Fence Modification in Activity A. Refer to Fence Modification in Activity A for information to prepare a specific fence modification proposal for the plan under this Activity. This practice can not qualify under more than one Activity.

FOOD PLOTS

The establishment of locally adapted annual or perennial forages on suitable soils to provide supplemental foods and cover during critical periods of the year. **This practice is generally not practical in west Texas without irrigation.** Livestock generally should be excluded from small food plots. The shape, size, and location of food plots and the percentage of total land area dedicated to food plots should be based on requirements for the target species (eg., 2-5% of area for deer or pronghorn) and should meet goals of a comprehensive wildlife plan. **A minimum of 1% of the acreage should be planted in both winter and summer food plots.**

Managing the habitat for proper nutrition should be the primary management goal. Supplemental feeding and /or planting of food plots are not a substitute for good management. These practices should only be considered as "supplements" to the native habitat, not as "cure-alls" for low quality and/or poorly managed habitats. Supplemental feeding should always be combined with population management, or the resulting artificially higher numbers of animals will have a negative impact on native plants. Consult with the NRCS, TCE, TPWD, and local seed dealers for food plot mixtures suitable for your area, as well as local soil conditions. Plant according to soil tests (through TCE County Extension Agent) and fertilize as necessary.

This practice may also include late winter disking to encourage the germination and growth of native forbs. This practice is most beneficial on properties with considerable grass cover (85%+) and relatively low availability of forbs and/or bare ground. Late winter disking promotes annual grasses and seed-producing forbs such as sunflower, croton (doveweed), ragweed, buffalo-bur, and pigweed, which can be particularly valuable to quail, doves, and other seed-eating birds. These patches of forbs also tend to harbor an abundance of insects that serve as forage for a variety of birds, reptiles, and other wildlife. If bobwhite or blue quail are the targeted species, the disked strips should meander through low-growth, woody cover. The strips should be disked in February or early March and may be conducted on the same acreage each year, or the soil disturbance can be alternated between adjacent strips. Disking should be conducted at a depth of 4-6" along the contour and only in areas where the slope does not exceed 3% (preferably less than 1%). **A minimum of 1% of the acreage should be disked annually to qualify.**

Proposed Food Plots Project(s) may include the following considerations:

- Size(s) _____
- Fencing required?
 - yes
 - no
- Plantings:
 - cool season annual crops, i.e. wheat, rye, clovers, etc.
 - warm season annual crops, i.e. sorghums, millets, cowpeas, etc.
 - annual mix of native plants
 - perennial mix of native plants
- Irrigation required?
 - yes
 - no
- Fertilizer recommended?
 - Yes
 - no

FEEDERS AND MINERAL SUPPLEMENTATION



Dispensing supplemental foods from artificial devices to meet the nutritional requirements of selected wildlife species during critical periods of the year. This practice must be a part of a comprehensive habitat management plan that addresses all animal units and attempts to maintain populations below carrying capacity. Using feeders to attract big game animals for harvest does not apply unless used for **selective harvest** to control excessive numbers of deer and/or exotic ungulates as defined within a

comprehensive wildlife management plan. The plan should include a targeted harvest quota that is regularly measured and achieved or nearly so. Aflatoxin levels in grain feeds should not exceed 20 ppb. Mineral supplementation may be supplied from artificial devices or by other means (poured on ground, blocks, etc.).

For big game animals and wild turkeys, **a minimum of one free-choice feeder, feeding station and/or mineral station per 2 sections (1,280 acres) is required to qualify** (See Appendix G and H for deer; See Appendix O for turkeys). Feeders must be in use during recommended seasons and appropriate supplements must be provided. For deer, protein supplements (cottonseed cake, whole cottonseed, 16% or 20% protein pellets, etc.) may be provided during any season, while energy

supplements (corn, whole cottonseed, etc.) may be used during late summer/early fall and winter. For quail and other birds, **a minimum of one free-choice feeder per 640 acres is required to qualify** (See Appendices P, Q and R for quail). Because the distribution of each wildlife species is dictated by habitat type, the above standards for qualification apply only to the portions of the property where the target species occur.

Proposed Feeders and Mineral Supplementation Project(s) should include the following considerations:

- Purpose:
 - supplementation
 - harvesting of wildlife
- Targeted wildlife species
- Feed type
- Mineral type
- Feeder type
 - Number of feeders
- Method of mineral dispensing
 - Number of mineral locations
- Year round
 - Yes
 - No, if not, when practiced_____

MANAGING TAME PASTURE, OLD FIELDS AND CROPLANDS

This practice may include: over-seeding or planting cool season and/or warm season legumes and/or small grains in pastures, easements (pipelines), or range land in order to provide a supplemental food for wildlife, using plant materials and establishment methods applicable to the county; periodic ground disturbance through shallow discing that encourages habitat diversity, the production of native grasses and forbs for supplemental foods, increasing bare ground feeding habitat for selected species. Conservation tillage practices are recommended that leave waste grain and stubble on the soil surface until the next planting season to provide supplemental food or cover for wildlife, control erosion, and improve soil tilth. Shred, disk, and/or fertilize native vegetation to improve the growth and quality of plants. Many broadleaf plants (forbs - weeds and wildflowers) are beneficial to wildlife for forage and/or seed production. Encourage "weed and wildflower" species by selective application of chemical, biological (eg., grazing management) and/or mechanical means on native range lands and non-native grass pastures. **A minimum of 5 percent of the designated area must be treated annually to qualify.**

PROVIDING SUPPLEMENTAL SHELTER

The best shelter and cover for wildlife is provided by a well managed habitat. Some

practices can be implemented to provide types of shelter that may be limited in the habitat.

NEST BOXES, BAT BOXES

The installation of artificial boxes or cavities to provide nesting or denning habitat for selected species. **Number and location of nest boxes should be consistent with habitat needs and territorial requirements of the target species, and sufficient over the area to provide a real supplement to the target population and address an identified severe limiting factor as part of a comprehensive wildlife management plan.**



Proposed Nest Boxes, Bat Boxes Project(s) may include:

- Targeted species: _____
- Box type:
 - cavity type.
 - bat boxes.
 - raptor poles.

BRUSH PILES AND SLASH RETENTION

The planned construction, maintenance, and/or retention of brush piles to provide additional wildlife cover in habitats where low-growth, woody cover has been identified as a limiting factor for the selected species. This practice includes leaving dead brush on the ground where it was cut or uprooted to provide wildlife cover and protection for seedlings of desirable plant species. Stacking posts or limbs in a “teepee” arrangement can provide adequate cover for small game and other wildlife in open areas. Fastening the posts/limbs with wire will substantially extend the usefulness of these structures. Some of the most valuable, long-term brush piles for bobwhite quail, scaled quail, cottontail rabbits, and other wildlife are those suspended 8-10” above the ground by short corner posts and a wire frame (strand and netting). In areas devoid of low-growth woody cover, brush piles should be at least 15’ in diameter and constructed no more than 100 yards apart or about one per acre. In areas with some existing woody cover, artificial brush structures can be constructed at lower densities and still provide a substantial benefit. This practice must be part of a comprehensive wildlife management plan. **A minimum of 10% of the designated area or 10 acres, whichever is less, must be treated annually to qualify.**

FENCE LINE MANAGEMENT

Maintain, establish, or allow the establishment of trees, shrubs, forbs, and grasses

along fence lines to provide wildlife food and cover (minimum width of 30 feet). The wider the corridor or cover strip (eg., 60 feet or 90 feet), the more beneficial it is for wildlife. For example, narrow strips of cover may successfully be used for fawning cover or nesting cover; however, the narrower the strip, the easier it is for predators to find nests or fawns. This practice is only applicable where cover is limiting in the habitat (i.e., cropland or tame pasture) and must be part of a comprehensive wildlife management plan. **A minimum length of 300 feet of Fence Line Management per ¼-mile of applicable fence must be completed/initiated annually to qualify.**

CROPLAND MANAGEMENT FOR WILDLIFE

Use of no till/minimum till agricultural practices to leave waste grain and stubble on the soil surface until the next planting season to provide supplemental food or cover for wildlife, control erosion, and improve soil tilth. Other forms of supplementing and providing shelter include roadside right-of-way management for ground-nesting birds, establishing perennial vegetation on circle irrigation corners, levees, dikes, terraces, fencerows and field borders, establishing multi-row shelterbelts or renovating old shelterbelts, and protecting and managing old homesites, farmsteads and Conservation Reserve Program cover. Weeds are an important source of food for many wildlife species; therefore, weed control practices should be minimized.

Cropland Management Project(s) should consider:

- Acreage to be treated
- Shelter establishment:
 - irrigation corners
 - road side management
 - terrace/wind breaks
 - field borders
 - shelterbelts
- Conservation Reserve Program lands management
- Type of vegetation for establishment:
 - annual
 - perennial
- List species and percent of mixture
- Deferred mowing
 - Period of deferment
- Mowing
 - Acres mowed annually
- No till/minimum till

HALF-CUTTING TREES OR SHRUBS

The practice of partially cutting branches of a live tree or shrub



In open areas with very little near-ground cover, cutting half-way through the lower mesquite limbs and breaking them to the ground can form a "cage" that provides escape and roost cover for wildlife.

to encourage horizontal, living cover near the ground, providing overhead cover for selected species in habitats where low-growth, woody cover has been identified as a limiting factor (see TPWD Bulletin 48). This practice, which should be conducted during the growing season when sap is flowing, also serves to protect nesting cover and other desirable herbaceous plants from grazing animals. This practice is most effective when small groups or clumps (4-5 trees) of shrubs are half-cut within 15-30 feet of each other.

A minimum of one clump of trees/shrubs per 100 yards (~1 per acre) on at least 10 percent of the designated acreage or on 10 acres, whichever is less, must be developed annually to qualify.

WOODY PLANT/SHRUB ESTABLISHMENT

Planting and protecting native seedlings to establish wind rows and shrub thickets, or to restore wooded habitats within former croplands, tame pastures or CRP land. In agricultural areas, this practice may include **planting a minimum of 50 seedlings annually in mottes, clumps, or short rows.** Plantings should consist of native trees and shrubs that produce hard or soft mast, or provide nesting or escape cover. Plantings should be made in groups to provide both cover and additional food, rather than scattered individual trees. For most sites in the Trans Pecos, irrigation of woody plantings is necessary for the first 3-5 years to improve survival.

See Brush Management in Activity A for information on other practices (shrub mottes) that may qualify under this activity. This practice can not qualify under more than one Activity.

NATURAL CAVITY/SNAG DEVELOPMENT

Create and/or retain “snags” (dead trees) for cavity-dwelling species. Undesirable trees can be girdled or individually treated with herbicide and left standing. This practice will have limited applicability in the Trans-Pecos where trees along riparian areas are relatively rare and valuable to a variety of wildlife species. Retention of naturally developed snags generally will be more appropriate than the intentional development of snags. Special measures must be implemented to protect the snags during prescribed burning, mechanical brush management, etc. **A minimum of 1 snag per acre on the applicable portion of the property must be created/retained annually to qualify.**



Girdling trees is an effective means of creating snags, but be selective by avoiding mast producing trees (oaks, hickories) and judicious in extent.

CENSUS

This activity provides an estimate of species numbers, population trends, population density, age structure, or sex ratio using accepted survey techniques. Results of annual surveys should be recorded on appropriate forms as evidence of completion of this practice. Selection of specific survey techniques should be appropriate to the species of interest and at a level of intensity to achieve proper management of the resource in connection with a comprehensive wildlife management plan.



Note: For census activity to qualify for deer, a combination of methods must be used to obtain a reasonable assessment of the deer herd for habitat and harvest management. For most (but not all) properties, this will require spotlight surveys, daylight or incidental observations, and harvest data for all deer (age, weight, and antler measurements). Similar intensity should be applied for other species to qualify in this activity.

SPOTLIGHT COUNTS

Counting animals at night along a predetermined route using a spotlight. Spotlight counts should follow accepted methodology. **A minimum of three counts must be completed annually. At least 10% of the total acreage should be observed during the spotlight survey.**

AERIAL COUNTS

Use of a fixed-wing aircraft or helicopter to count animals. **Counts should employ accepted methodology for the region and be performed by a trained individual annually.**

DAYLIGHT DEER HERD, WILDLIFE COMPOSITION COUNTS, PHOTO STATIONS

Counts used to census deer in daylight hours to improve information of sex/age structure (buck/doe/fawn), as well as to determine annual trends in populations through dove, quail, and turkey sightings. **Counts to evaluate trends in wildlife numbers should be conducted on a standardized route that is at least 5 miles in length and**

run at least 3 times. If shorter routes are used, a total of at least 15 miles must be surveyed. Other standardized methodology may be used to obtain at least 100 observations. For example, sex and age information for deer may be obtained from areas where deer concentrate, such as watering sites, crop fields, food plots, deer feeders, etc. **Observations from stationary blinds should involve at least 5 separate, 2-hour counts during early morning or late afternoon.**

HARVEST DATA COLLECTION/RECORD KEEPING

Collect all age, weight, and antler development data from harvested deer. Age and sex information should be obtained from game birds and waterfowl to determine sex ratios and annual production.

BROWSE UTILIZATION SURVEYS

Annually (normally during the winter) examine deer browse species for degree of utilization on each major vegetative site on the property through vegetation analysis and stem counts.

CENSUS OF ENDANGERED, THREATENED, OR PROTECTED WILDLIFE

Regular, periodic counts of the target species used to enhance management or increase knowledge of local, regional, or state status.

CENSUS AND MONITORING OF NONGAME WILDLIFE SPECIES

Regular, periodic counts of nongame wildlife species used to enhance management or increase knowledge of local, regional, or state status. This practice would also include developing checklists of wildlife diversity for the property, and should be a part of a comprehensive wildlife management plan.

MISCELLANEOUS COUNTS:

Specific species may require special survey techniques. These may include the following and should be addressed in the management plan:

- Time/area counts
 - Roost counts
 - Song bird transects and counts
 - Quail call and covey counts
 - Point counts
 - Drift fences and pitfall traps
 - Small mammal traps
 - Bat census (ex. Departures)
 - Other. Describe:
-

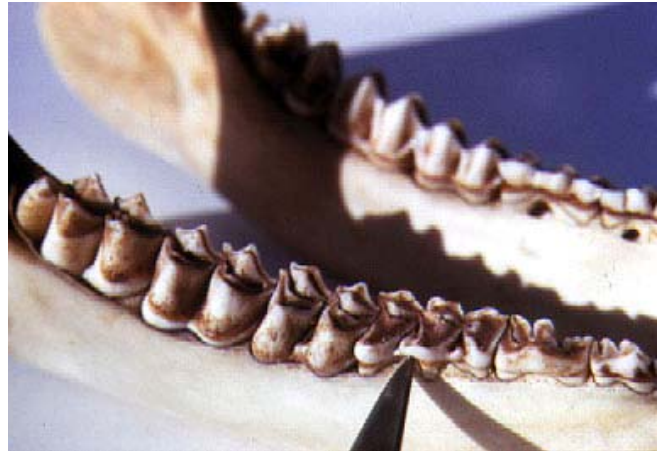

Keeping good harvest records is essential to understanding effects on target populations. Lower jaw bones are used to age deer, and deer aging publications may be obtained from Texas Parks and Wildlife or your County Extension Agent.



Appendix B

Wildlife Tax Valuation Rules

Refer to the Texas Administrative Code link below for the complete text of all rules as adopted in December 2008:

[http://info.sos.state.tx.us/pls/pub/readtac\\$ext.ViewTAC?tac_view=5&ti=34&pt=1&ch=9&sch=G&rl=Y](http://info.sos.state.tx.us/pls/pub/readtac$ext.ViewTAC?tac_view=5&ti=34&pt=1&ch=9&sch=G&rl=Y)

The following is a summary of changes made by the new rules that were adopted on December 11, 2008. Our purpose is to give an overview of rule changes for use by landowners and those that assist them. If you have questions, please contact Linda Campbell (512-389-4395) or Todd George (512-389-4329), Texas Parks and Wildlife Department, Austin.

1. New definitions have been added and some existing definitions have been clarified

- Wildlife Management Practices are defined as those listed in the Tax Code (23.51(7)(A) - Habitat Control, Erosion Control, Predator Control, Providing supplemental supplies of water, Providing supplemental supplies of food, providing shelters, Making census counts to determine population.
- Wildlife Management Activities are defined as methods of implementing wildlife management practices as described in the TPWD guidelines for each region.
- The definition of a tract of land was changed to clarify that tracts of land will be considered contiguous even though they are bisected by a public road or body of water.
- The definition of Wildlife Management Property Association was changed to clarify that tracts of land of landowners in the association will be considered contiguous even though they are bisected by a public road or body of water. Other requirements are the same.
- The term sustained breeding population was changed to breeding population to be consistent with the Tax Code and because the term sustained refers to breeding, migrating, and wintering populations of wildlife. The definition is the same.
- The term Wildlife Use Percentage has been changed to Wildlife Use Requirement in recognition that the formula that determines the minimum acreage requirements is not actually a percentage of use.

2. Changes to the Wildlife Use Appraisal Regions

The appraisal regions have been reorganized to more closely track the defined ecological regions as specified in the TPWD Wildlife Management Guidelines. If a county is in more than one ecological region, the region that comprises the majority of the county was selected.

Trans Pecos

- Brewster
- Crane
- Culberson
- El Paso
- Hudspeth
- Jeff Davis
- Loving
- Pecos
- Presidio
- Reeves
- Terrell
- Ward
- Winkler

High Plains

- Andrews
- Armstrong
- Bailey
- Carson
- Castro
- Cochran
- Crosby
- Dallam
- Dawson
- Deaf Smith
- Ector
- Floyd
- Gaines
- Glasscock
- Hale
- Hansford
- Hartley
- Hockley
- Howard
- Hutchinson
- Lamb
- Lubbock
- Lynn
- Martin
- Midland
- Moore
- Ochiltree
- Oldham
- Parmer
- Potter
- Randall
- Sherman
- Swisher
- Terry
- Upton

- Yoakum

Rolling Plains

- Archer
- Baylor
- Borden
- Briscoe
- Callahan
- Childress
- Clay
- Coke
- Coleman
- Collingsworth
- Concho
- Cottle
- Dickens
- Donley
- Fisher
- Foard
- Garza
- Gray
- Hall
- Hardeman
- Haskell
- Hemphill
- Jones
- Kent
- King
- Knox
- Lipscomb
- McCulloch
- Mitchell
- Motley
- Nolan
- Roberts
- Runnels
- Scurry
- Shackelford
- Stonewall
- Taylor
- Throckmorton
- Tom Green
- Wheeler
- Wichita
- Wilbarger

Western Edwards Plateau

- Crockett
- Edwards

- Irion
- Kimble
- Menard
- Reagan
- Real
- Schleicher
- Sterling
- Sutton
- Val Verde

Eastern Edwards Plateau

- Bandera
- Bexar
- Blanco
- Burnet
- Comal
- Gillespie
- Hays
- Kendall
- Kerr
- Llano
- Mason
- San Saba
- Travis
- Williamson

Cross Timbers and Prairies

- Bell
- Bosque
- Brown
- Comanche
- Cooke
- Coryell
- Denton
- Eastland
- Erath
- Hamilton
- Hood
- Jack
- Johnson
- Lampasas
- Mills
- Montague
- Palo Pinto
- Parker
- Somervell
- Stephens
- Tarrant

- Wise
- Young

South Texas Plains

- Atascosa
- Dimmit
- Duval
- Frio
- Jim Hogg
- Kinney
- LaSalle
- Live Oak
- Maverick
- McMullen
- Medina
- Starr
- Uvalde
- Webb
- Zapata
- Zavala

Blackland Prairie

- Collin
- Dallas
- Delta
- Ellis
- Falls
- Fannin
- Grayson
- Hill
- Hunt
- Kaufman
- Lamar
- Limestone
- McLennan
- Milam
- Navarro
- Rockwall

Post Oak Savannah

- Bastrop
- Bee
- Brazos
- Burleson
- Caldwell
- DeWitt
- Fayette
- Franklin
- Freestone
- Goliad

- Gonzales
- Grimes
- Guadalupe
- Henderson
- Hopkins
- Karnes
- Lavaca
- Lee
- Leon
- Madison
- Rains
- Red River
- Robertson
- Titus
- Van Zandt
- Washington
- Wilson

Pineywoods

- Anderson
- Angelina
- Bowie
- Camp
- Cass
- Cherokee
- Gregg
- Hardin
- Harrison
- Houston
- Jasper
- Liberty
- Marion
- Montgomery
- Morris
- Nacogdoches
- Newton
- Panola
- Polk
- Rusk
- Sabine
- San Augustine
- San Jacinto
- Shelby
- Smith
- Trinity
- Tyler
- Upshur
- Walker
- Wood

Upper Gulf Prairies and Marshes

- Austin
- Brazoria
- Calhoun
- Chambers
- Colorado
- Fort Bend
- Galveston
- Harris
- Jackson
- Jefferson
- Matagorda
- Orange
- Victoria
- Waller
- Wharton

Lower Gulf Prairies and Marshes

- Aransas
- Brooks
- Cameron
- Hidalgo
- Jim Wells
- Kenedy
- Kleberg
- Nueces
- Refugio
- San Patricio
- Willacy

Wildlife Use Appraisal Regions

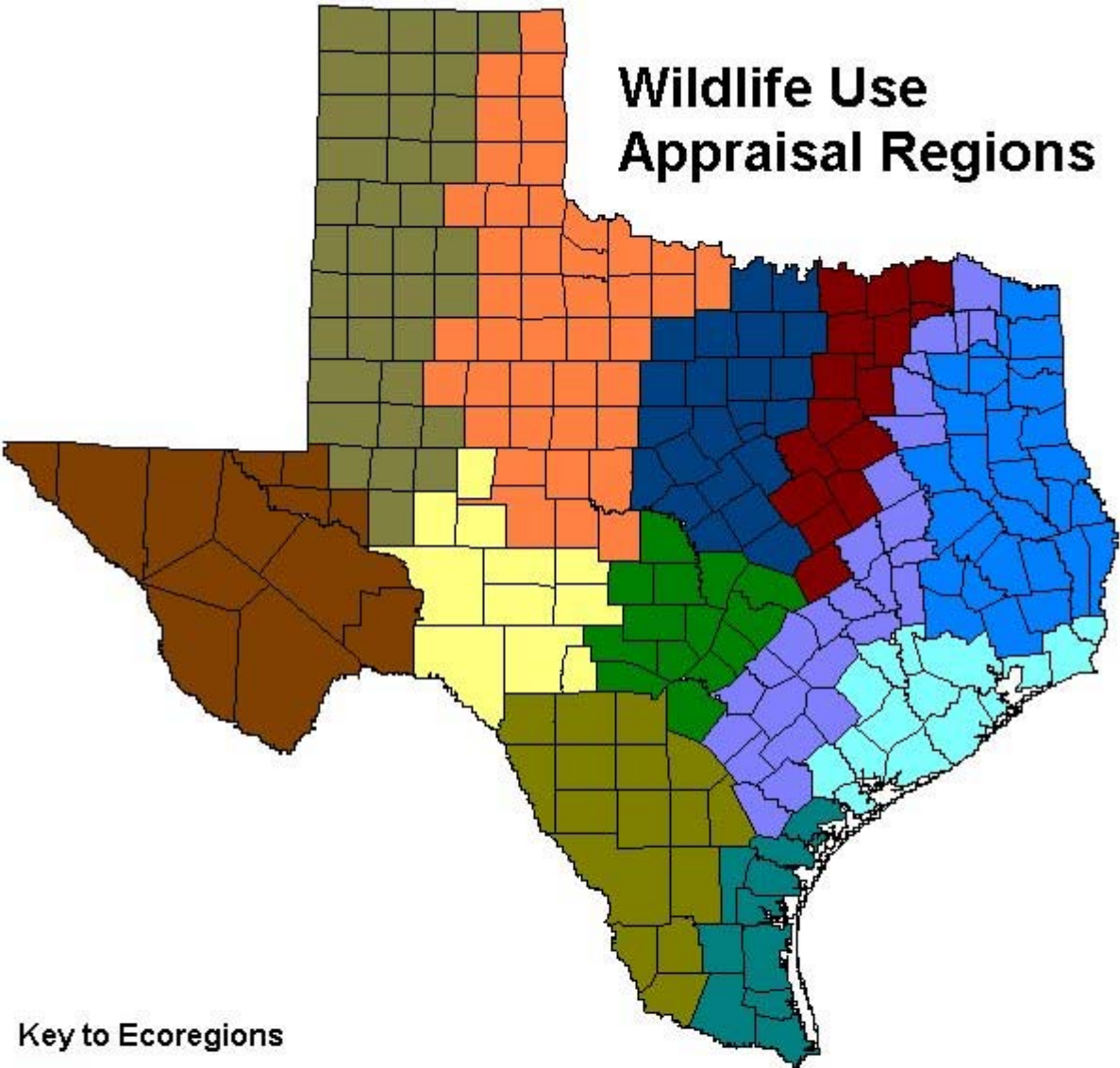

Key to Ecoregions

- | | |
|--|---|
|  Trans Pecos |  South Texas Plains |
|  High Plains |  Blackland Prairie |
|  Rolling Plains |  Post Oak Savannah |
|  Western Edwards Plateau |  Pinewoods |
|  Eastern Edwards Plateau |  Upper Gulf Prairies & Marshes |
|  Cross Timbers & Prairies |  Lower Gulf Prairies & Marshes |

3. Changes to the Wildlife Management Plan (WMP) requirements are as follows:

- The Chief Appraiser may accept, but may not require, a WMP not completed on a TPWD form. All required information must be provided.
- An appraisal district may require an annual report.
- A Wildlife Management Property Association may file a single WMP or annual report, but all members must sign the WMP or annual report.
- Practices implemented in WMPs must not harm endangered species, but they are not required to benefit these species – the change mirrors requirements of the Endangered Species Act.

4. Changes to the Qualifications for Wildlife Management Use are as follows:

- The TPWD Comprehensive Wildlife Management Guidelines set the degree of intensity standard for wildlife management practices and activities implemented in the various ecological regions.
- The landowner selects which 3 of 7 wildlife management practices to implement each year.
- Property must now be "actively managed" to sustain a breeding, migrating, or wintering population of indigenous wildlife, where prior rule required that the land was "instrumental in supporting" this wildlife.
- Primary Use is the same as Principal Use and is defined as:
 - The property is actively managed according to a WMP.
 - Wildlife management practices and activities are given priority over other uses.
 - Secondary uses of the land do not significantly and demonstrably interfere with wildlife management practices and activities and are not detrimental to the wildlife being managed.

5. Changes to Wildlife Use Requirement are as follows:

- Use or minimum acreage requirements now apply only when the property has had a reduction in acreage – it no longer requires both a change in ownership and a reduction in acreage.
- The Chief Appraiser in each county, with the advice and consent of the Appraisal District Board of Directors, now selects the wildlife use requirement from the allowable range based on the appropriate appraisal region.
- Minimum acreage ranges are the same except for Terrell (increase), Clay (increase), McCulloch (increase) and Bee (decrease) counties. Changes result from the reorganization of appraisal regions.
- Existing properties in wildlife management are grandfathered and not affected by these changes.

Appendix C

Wildlife Management Plan Overview

Use this list to assist in planning your wildlife management activities

TREATMENTS	Practice	Year 1	Year 2	Year 3	Year 4	Year 5
Habitat Control:						
HC: Wildlife & Habitat Management Plan						
HC: Grazing Management						
HC: Prescribed Burning						
HC: Range Enhancement (re-seeding)						
HC: Brush Management						
HC: Vegetation Surveys						
HC: Fence Modification						
HC: Riparian Management and Enhancement						
HC: Wetland Enhancement						
HC: Habitat Protection/Species of Concern						
HC: Prescribed Control of Species						
HC: Wildlife Restoration						
Erosion Control:						
EC: Pond Construction						
EC: Gully Shaping						
EC: Streamside, Pond, Wetland Revegetation						
EC: Native Plant Establishment on Erodible Areas						
EC: Dike/Levee Construction/Management						
EC: Establish Water Diversion						
Predator Control:						
PC: Predator Management						
PC: Control of Brown-headed Cowbirds						
PC: Grackle/Starling Control						
Supplemental Water:						
SW: Marsh/Wetland Restoration or Development						
SW: Well/Trough/Windmill Overflow						
SW: Spring Development and/or Enhancement						
Supplemental Food:						
SF: Grazing Management						
SF: Prescribed Burning						
SF: Range Enhancement (Re-seeding)						
SF: Fence Modification						
SF: Food Plots						
SF: Feeders and Mineral Supplementation						
SF: Managing Tame Pasture, Old Fields, Croplands						
Providing Shelters:						
PS: Nest Boxes, Bat Boxes						
PS: Brush Piles and Slash Retention						
PS: Fence Line Management						
PS: Cropland Management						
PS: Half-Cutting Trees or Shrubs						
PS: Woody Plant/Shrub Establishment						
PS: Natural Cavity/Snag Development						
Census:						
C: Spotlight Counts						
C: Aerial Counts						
C: Daylight Wildlife Counts						
C: Harvest Data Collection & Record Keeping						
C: Browse Utilization Surveys						
C: Endangered, Threatened or Protected Species						
C: Nongame Wildlife Species						
C: Time/area Counts						
C: Roost Counts						
C: Song Bird Transects and Counts						
C: Quail Call and Covey Counts						
C: Point Counts						

Appendix D

Livestock Management Recommendations

Livestock management has a greater influence on wildlife habitat and wildlife populations in the Trans-Pecos than any other management practice (with the possible exception of fire). Livestock management practices can be beneficial or detrimental to wildlife, depending on the kind of livestock, stocking rate, duration of grazing, and grazing system.

Kind/Class of Livestock

Sheep and goats have diets similar to deer and often compete with them for available forage. There is considerable overlap in sheep and pronghorn diets, and competition for forage (especially forbs) can be significant. Goats can reduce the amount of low-growing woody plants which are required by many wildlife species for food and cover. Under light to moderate stocking rates, cattle grazing tends to be compatible with most wildlife species.

Stocking Rates (acres per animal unit)

Livestock and wildlife can do very well on the same range; however, when livestock numbers are excessive, they will compete with deer, pronghorns, and other wildlife for available forage and can severely impact reproductive and escape cover. **Stocking rates have a greater impact on wildlife habitat than any other factor of grazing management.** Maintaining light to moderate stocking rates will help to maintain or improve wildlife habitat. Deer and pronghorns are usually at a disadvantage on overgrazed ranges because livestock normally receive supplemental feed when forage is limited. On overgrazed rangelands, reducing livestock numbers is preferable to supplemental feeding of wildlife and the only way of allowing the habitat to recover. Land managers should not rely on traditional or historic stocking rates. Stocking rates should initially be based on the Natural Resources Conservation Service (NRCS) recommended rate and then adjusted as needed to balance forage production with animal numbers. To ensure proper use of forage, recommended stocking rates should be calculated by pasture because of differences in range sites, vegetation communities, and forage production.

Grazing Management Plan

Planning and flexibility are the keys to proper range management. For example, the manager that plans ahead can temporarily limit grazing in pastures traditionally used as fawning grounds by deer or pronghorns. Also, a flexible grazing system is essential to insure proper use of forage, the production of which is highly variable in the Trans-Pecos. Not only is it economically important to the rancher but necessary for maintaining quality wildlife habitat. A flexible grazing plan will allow managers to adjust stocking rates when necessary and to use kinds and classes of livestock that are

compatible with wildlife species of interest.

The Grazing Management Plan should include:

Kind of Livestock: Brangus cattle, Horses, Angora goats, Rambouillet sheep, etc.

Class of Livestock: Cow/calf, Steers, etc.

Stocking rate: Acres per animal unit

Type of Grazing System: 2 Pasture- 1 Herd, 4 Pasture- 3 Herd , HILF, etc.

Grazing Systems

A well-planned grazing system is one which allows adequate rest periods for plants to recover after grazing. Most domestic livestock are selective grazers and consume the most nutritious and palatable plants first. Whenever a plant is eaten, not only is there a reduction in top growth but also a reduction in root growth. A stunted root system directly affects the plant's ability to regrow following defoliation. Herbaceous plants need at least 30 to 60 days of rest to recover from grazing, depending on the growth stage, severity of defoliation, moisture conditions, and temperature. Woody plants need as long as 4 to 6 months of rest to allow for regrowth.

The grazing system that is least compatible with wildlife habitat management is continuous, year-long grazing. This type of grazing usually results in overuse and elimination of the most palatable and nutritious plants and increases undesirable, less palatable plants. Continuous grazing generally results in a gradual decline in range condition, reducing long-term carrying capacity for livestock and habitat quality for most wildlife species. Continuous grazing should not be used as a grazing method if the land manager's desire is to improve habitat for wildlife.

Most North American rangelands (including west Texas) evolved under grazing by nomadic animals such as bison, elk, and pronghorn, whose herd movements resulted in a crude form of seasonal grazing deferment. Rangelands respond best to grazing systems that closely mimic the behavior of these nomadic herds. A deferred-rotation grazing system that incorporates rest and graze periods to regulate the intensity and duration of forage plant use helps to promote plant vigor, seed production, and seedling establishment.

The absence of livestock grazing (or fire) over long periods of time can be as detrimental to range condition and wildlife habitat as overgrazing. Total protection of rangelands in western Texas from livestock generally fails to restore degraded vegetation communities because these plants evolved under a natural system of periodic fires and grazing. Several livestock grazing systems have been developed which provide adequate periods of rest and allow plants to recover from grazing. Each ranch manager should implement the system that best fits their particular situation. Some commonly used deferred-rotation grazing systems are: two pasture/one herd, three pasture/one herd, four pasture/one herd, high intensity/low frequency (HILF), short duration grazing, and four pasture/three herd. Regardless of the type of grazing system

used, their success primarily depends upon stocking rate, kind of livestock, rainfall during the rest period, and the time of year in which the pasture is rested and grazed. Grazing schedules and livestock stocking rates for pastures within a grazing system need to be flexible and continually reevaluated based on rainfall patterns, seasons of the year, and on-site conditions (i.e., range sites, vegetation type, forage production). Determining the appropriate graze and rest periods for each pasture is as much of an art as a science and depends more on local range conditions than on the calendar.

Below are brief descriptions of various deferred-rotation grazing systems. There are many variations of each system and land managers can modify the grazing schedules to fit their situation. For example, ranches that are grazed only a portion of the year (eg., stocker operations) can modify grazing schedules to match the number of months of grazing (the grazing schedules described below assume year-long grazing). The grazing systems described are easier to operate and often more efficient in forage use when pastures are of **similar grazing capacity** (combination of pasture size and soil productivity). When pastures are not of similar grazing capacity, one option is to base stocking rates on the pasture with the least grazing capacity (to prevent overgrazing of smaller or less productive pastures). Another alternative is to base the stocking rate on the total grazing capacity of all pastures and modify the grazing schedule of a rotational system to match the grazing capacity of individual pastures. However, it is critical to maintain a “rotating” rest period – each deferred rotation system was designed to rotate the rest period for each pasture among different times of the year (naturally, it follows that the pastures are grazed during different seasons or months). This continual variation in **timing** of the rest period is the key to improving plant health and species composition.

Two pasture/one herd rotation - All livestock are confined to one pasture, which is grazed for 3 months. The herd is then moved to the second pasture for 6 months. The herd is then moved back to the first pasture for 6 months, then back to the second for 3 months, and so on, continuing with the 3 month/6 month cycle.

Three pasture/one herd rotation - A single herd of livestock is rotated from one pasture to another every 3 months. This allows each pasture to receive 6 months of rest before being grazed again. Over time, the pastures are grazed during different seasons of the year, with a 3 year interval occurring before an individual pasture is grazed during the same season again.

Four pasture/one herd rotation - A single herd of livestock is rotated from one pasture to another every 2 months. Each pasture receives 6 months of rest before being grazed again, with a 2-year interval occurring before an individual pasture is grazed during the same time period.

High intensity/low frequency (HILF) - The number of pastures in this system is variable, but it typically incorporates a minimum of 6 to 8 pastures. The livestock are kept in one herd, and each pasture is grazed for approximately 1 to 1 1/2 months (high intensity), followed by a long period of rest (low frequency). Listed below are the calculations for

determining how long each pasture should be grazed under a HILF system, using a system with 7 pastures as an example:

- 1.) add 1 to the number of pastures in the system ($7+1=8$)
- 2.) divide the number of days in a year by the answer from step 1 to determine how many days each pasture should be grazed (365 days divided by 8 = 46 days of grazing per pasture).
- 3.) It would take 322 days (7 pastures X 46 days each = 322 days) to complete the grazing cycle, and each pasture would receive 276 days of rest between grazing periods.

Short duration grazing - This system requires that a ranch be divided into numerous pastures, typically 12 to 20 (no fewer than 8). The livestock are kept in one herd and the herd is rotated through the pastures. Each pasture is grazed for a short period of time (a few days), followed by 1 to 4 months of rest. The length of the grazing cycle is based on the rate of forage regrowth. For example, a 30 to 45-day cycle may be used during the peak of the growing season when plants recover more rapidly after being grazed. In a system with 12 pastures or paddocks, each pasture could be grazed for 3 days, resulting in a 36-day grazing cycle and 33 days of rest per pasture. As the growth rate of forage begins to slow, the rest period can be increased by slowing to a 6-day graze period (72-day cycle). The cycle could be further lengthened during winter dormancy (eg., 10-day graze period and 120-day cycle) when warm-season plants can withstand heavier grazing pressure without damage.

Four pasture/three herd rotation - Livestock are divided into 3 herds and stocked in 3 of the 4 pastures. On a rotating basis, one herd is moved to a vacant pasture every 4 months. Each pasture is grazed for 1 year and rested for 4 months. This allows each pasture to be rested from grazing during each month of the year (three 4-month periods) upon completion of a 4-year cycle. The four pasture/three herd system is the least preferred rotational grazing method for improving plant species composition because of the long period of time that livestock remain in each pasture.

A deferred-rotation grazing system will fail to produce the desired results of maintaining a healthy and diverse plant community if the range is overstocked with animals, both domestic and wild. Appropriate stocking rates vary by pasture and by range sites within pastures, but they can also vary from year to year and seasonally within a year, depending on environmental factors. The impact of grazing animals should be closely monitored, and the number of livestock on a ranch may need to be adjusted periodically in response to changes in a ranch's grazing capacity. The combined total of all animals on the range, including all classes of livestock as well as deer and exotics, must be considered when determining stocking rates. The following equivalent values of animal unit standards can be used to make stocking rate decisions:

<u>Cattle</u>	<u>Animal Units</u>
weaned calves to yearlings	0.6
steers and heifers (1 to 2 years)	1.0
mature cows, with or without unweaned	1.0

calves at side	
bulls (2 years and over)	1.3

Sheep

5 weaned lambs to yearlings	0.6
5 mutton or ewes (1 to 2 years)	1.0
5 mature ewes, with or without unweaned lambs at side	1.0
5 rams	1.3

Goats

6 weaned kids to yearlings	0.6
6 nannies or wethers (1 to 2 years)	1.0
6 nannies, with or without unweaned kids at side	1.0
6 billies or wethers over 2 years	1.3

<u>Horses</u>	1.0-1.5
---------------	---------

Deer

5 deer (large bodied mule deer)	1.0
6 deer (whitetails or relatively small mule deer)	1.0

Exotics (depends on the species; use animal unit standard for similar size domestic animal)

Water Distribution

Since livestock are confined to individual pastures in a deferred-rotation grazing system, each pasture needs to have at least one source of water available when livestock are in that pasture (when livestock have vacated a pasture, these water sources can be extremely important to wildlife if left "on"). Creeks and draws that provide seasonal water are beneficial to livestock as well as wildlife but are of little value during extended dry periods. Earthen stock tanks and/or water piped to troughs from a well will provide better, more reliable sources of water. One watering facility can serve several pastures if properly located, provided the pastures are relatively small. For example, a water trough could serve two pastures if straddled by a cross-fence. Similarly, a trough in a separately fenced "waterlot" constructed at the juncture of several cross-fences could serve numerous pastures. For larger pastures that exist on many west Texas ranches, several watering sites per pasture may be required. Although not necessary, a watering site per 2,500 acres would be ideal because animals would always be within a mile of water. The better the water distribution in large pastures, the better the grazing distribution and livestock performance (increased forage availability and decreased energy expenditure). Additionally, if these watering facilities are "user-friendly" for local wildlife species, improved water distribution can, in effect, increase useable habitat on the ranch. For water sources designed specifically for wildlife, see Appendix V (Wildlife

Watering Facilities).

Grazing Lease

When leasing grazing rights, a written lease agreement can help the landowner to maintain his rangeland and wildlife habitat in good condition by specifying the type of grazing system, kind of livestock, and the maximum/minimum stocking rate. Grazing schedules (length of graze and rest periods for each pasture) and stocking rates should be flexible and continually reevaluated as dictated by rainfall patterns, season of the year, and local range conditions. The landowner should retain the right to require the lessee to reduce and, in rare instances, increase the number of livestock to ensure the appropriate degree of use and rest for range plants.

Appendix E

Recommendations for Brush Management in West Texas

Woody plants (brush) provide escape cover, loafing cover, nesting habitat, thermal protection, and food (browse and mast) for a number of wildlife species. However, each wildlife species has a particular tolerance range concerning the density and canopy cover of brush. There are instances when the brush density increases beyond a particular species' habitat requirements and preferences. Excessive brush densities can hinder movement, reduce visibility of approaching danger, reduce grass and forbs by competing for moisture and nutrients, and can promote increased predator populations. In such instances, a land manager may want to consider some method of brush management as an option for improving the habitat quality for certain wildlife species. However, managers should avoid excessive removal of woody cover because inadequate cover can be just as detrimental as too much brush.

Several brush management options are available to help accomplish a manager's wildlife objectives. Most of these options fall into 3 categories: herbicides, prescribed fire, and mechanical treatments.

Herbicides

Herbicides may be applied in pellet or liquid form by aircraft (helicopter or fixed-wing) or by ground equipment (backpack sprayer, tractor spray-rig, etc.). Aerial methods allow large acreages of brush to be treated in a relatively short time, and are not limited by rough terrain. Ground-application methods are much more species- and area-specific. Aerial treatments can be applied in strips, as total coverage, or in a variable rate pattern (VRP). The VRP involves aerially applying different rates of herbicide in strips at right angles to each other. This pattern creates numerous small blocks of vegetation ("checkerboard effect") treated with different herbicide rates, ranging from none to heavy and resulting in diversity of vegetation responses. This method has the greatest applicability in areas with dense stands of mixed brush.



Use of helicopters to apply herbicide provides the convenience of aerial application with the added benefits of allowing precision application, virtually eliminating chemical drift, and allowing the landowner to selectively treat very specific areas.

Ground-application methods allow the manager to treat specific undesirable species while avoiding impacts on more desirable woody plants. Herbicides may be stem-applied, foliar- (leaf) applied, or soil-applied. Broadcast treatments are an option, but individual plant treatments provide the

ultimate in selectivity. For low-growth brush, a tractor with a boom-spray rig can be used to target specific areas such as the more responsive deep-soil lowlands, while avoiding less responsive, shallow-soil uplands. Brush management in drainage habitats should be carefully considered because these sites are important in providing food and cover for deer and other wildlife species. The structural features provide areas for midday loafing and bedding, and these moist, fertile sites are very important in producing quality forage. In very broad drainages where mesquite and other shrubs have become too dense, the removal or thinning of shrubs can produce a tremendous herbaceous response. However, it is important to maintain a "buffer" of woody plants along the creek or draw that dissects most drainages (at least 200 feet on each side). This stringer of shrubs and trees will prevent erosion, serve as a travel corridor for various wildlife species, and provide screening cover in an otherwise open habitat. In very narrow drainages, the best option may be to maintain the woody vegetation.

An important disadvantage of herbicides, other than cost, is that the production of some grasses and especially forbs may be suppressed for 1-2 years in treated areas. Although temporary, this can have a significant, short-term effect on deer, quail, and other species that rely heavily on forbs. Another common problem with herbicides, especially broadcast applications, is non-target damage or mortality to desirable woody plants. Unlike other brush management methods, herbicides leave the dead standing remains of woody plants after they have been killed. This may be a problem for some managers. On the other hand, standing shrub "skeletons" can provide an important habitat component for certain wildlife species. Some of the woody debris remaining after herbicide treatment can be eliminated with a prescribed fire (3-5 years later). Once the brush is finally killed by herbicide (sometimes it takes 2 growing seasons), the herbaceous vegetation normally responds with a flush of growth, which provides adequate fuel for a relatively hot burn that will consume smaller shrubs and branches of larger shrubs.

Prescribed Fire

Fire is an excellent wildlife management tool that can be useful in controlling undesirable woody plants or thinning undesirable densities of brush. Unfortunately, the brush species that most often are a problem in west Texas (mesquite, redberry juniper, creosote, and tarbush) are difficult to kill with fire. They generally will resprout from the roots during the following year. However, periodic fire can be a useful tool in controlling the height and canopy cover of brush species, especially mesquite and juniper. With the proper weather conditions and an adequate fuel load, periodic prescribed burning can top-kill these woody plants, and most importantly, prevent the establishment of new seedlings. For example, a very hot fire can kill mesquite seedlings that are less than 3 years old and juniper seedlings that are less than 8 years old. Woody plant reduction will conserve soil moisture and nutrients so that grasses and forbs can increase. The result will be improved cover and food for deer and other wildlife, and a gradually improving fuel load for future prescribed burns.

Most prescribed burns are conducted in late winter (February- March) to suppress woody plants and to improve plant health and plant species composition. Cool-season fires can improve the germination, growth, and vigor of desirable grasses and forbs, but the effects on brush suppression are temporary. Most woody species are only top-killed by cool-season fires and will resprout from the base. The historical expanses of grasslands that once occurred in west Texas were maintained by fires that primarily occurred during hot, dry summers. These summer fires were often caused by lightning strikes, although Native Americans set fires to attract game animals. Grasses certainly require a longer period to recover from a summer fire compared to a cool-season burn, but the long-term benefits may be worth the trade-off. Woody plants are often stressed during dry summers and when this stress is combined with the intense heat of a



summer fire, the result is an increased mortality of large woody plants and a high mortality of young woody plants. Also, seed germination of some of the more desirable plant species (e.g., sideoats grama, bluestems, legumes) is often stimulated by the intense heat associated with a summer fire. Because of the hazardous nature of summer burns, they should be conducted cautiously and only by an experienced fire crew.

In addition to being the most economical method of brush management, fire can also produce a desirable vegetation mosaic because of the discontinuity of fuel (grass) that often exists in arid regions. Although temporary (2-4 months), fire can also increase the palatability and nutrient content of browse as well as herbaceous vegetation. Rangelands in west Texas do not need to be burned more frequently than every 8-12 years, and the appropriate fire frequency will be dictated by the relative fire intensity.

Land managers should seek experienced assistance from Texas Parks & Wildlife Department, the Texas Agricultural Extension Service, or the Natural Resource Conservation Service if prescribed burning is selected as a range improvement tool. Prescribed burning without a detailed prescribed burning plan and preparatory work by the landowner is not advised.

Mechanical Control

Mechanical methods of brush management such as tree grubbing, dozing, roller

chopping, aeration, and chaining are generally recommended over chemical means. These methods are more selective, remove the brush canopy, and promote a variety of forbs and grasses through soil disturbance and decreased competition. Unlike herbicide treatments where forbs are suppressed for a year or two, mechanical treatments produce an almost immediate forb response (provided there is adequate soil moisture). Most brush species will quickly resprout unless their roots are removed through a technique such as grubbing. Top-removal methods such as roller-chopping, discing, and shredding will temporarily improve the palatability and nutritional quality of browse (regrowth) for deer and other browsing animals. Although the improved quality is relatively short-lived (3-4 months), top-removal can increase browse accessibility on taller species (hackberry, bumelia, oaks) for several years by reducing plant height. Because of the regrowth potential of most brush species, top-removal methods are not effective in providing a long-term reduction in the brush canopy or density. However, when prescribed fire is used as a follow-up treatment, the desired effects produced by mechanical brush control can be economically extended for a much longer period than by mechanical treatment alone.

When thinning or removing mesquite or juniper in rolling to rough terrain, management efforts should focus on the deep-soiled flats and lowlands while avoiding the ridges, upper slopes, canyon headers, and draws. The forage production (response) on the lower slopes and flats will be 4-5 times greater (or more) than on rocky, shallow-soiled areas. The shrubs on the upper slopes and ridges serve to stabilize the thin layer of soil that exists on these areas. This type of balance between woody cover and nearby grasslands can be maintained somewhat inexpensively by the use of prescribed fire. The rocky slopes usually don't grow enough fine fuel to carry a fire very far up the ridges (at least not an intense fire); therefore, the shrubs that provide soil protection and cover/food for wildlife are maintained on the upper slopes and ridges. With periodic fire (8-10 years), a good combination of grasses and forbs can be maintained on the deeper soils. When removing brush from flats and lowlands, it is important to maintain a buffer of woody plants along the draws (at least 200 feet on each side). These "stringers" of woody plants will serve as travel corridors for various wildlife species and as key sites for bedding and foraging, and will protect the soil from erosion during heavy rainfall events. When removing mesquite from broad flats and drainages, managers should consider maintaining a few mature mesquite trees. They provide shade for livestock and wildlife, they benefit the soil (nitrogen-fixing legume), the foliage provides fair browse, and the bean crops are excellent forage and highly preferred by livestock and a variety of wildlife species.

General Guidelines for Preferred Amounts of Woody Cover for Selected Wildlife Species¹

WT Deer	50-75% woody cover
Mule Deer	15-40% woody cover
Bobwhite quail	5-25% woody cover
Scaled quail	10-35% woody cover (includes very small shrubs)
Pronghorn	1-10% woody cover (includes yucca, cholla, etc.)

Turkey

40-60% (preferably trees and mast-producing woody plants)
(overstory, midstory, and understory)

¹ Each wildlife species will occur in areas with lesser and greater densities of brush cover. These guidelines represent the optimum range of cover for long-term production and survival of each species and correspond with cover amounts in which the greatest number of animals of each species normally occur. However, woody cover is only one of many habitat parameters and will not compensate for the absence of other important requirements.

Appendix F

Recommendations for Prescribed Burning in West Texas

Prescribed burning is a cost-effective tool for managing woody brush encroachment and improving plant species composition and wildlife habitat. Prescribed burning is conducted with a strategic plan that includes management objectives, weather conditions, fuel loads (woody and herbaceous), protection of livestock and human structures, personnel required to implement the burn, and safety of the fire crew.

The Role of Fire in Desert Grasslands¹

Many grasslands in the Chihuahuan Desert have given way to higher densities of shrubs in the past 100 years, but the mechanisms contributing to the shrub invasion are not well understood. Thornber (1907, 1910), Griffiths (1910), Wooton (1916), Leopold (1924), and Humphrey (1958) were convinced that fire was the primary mechanism that controlled shrubs in the southwestern deserts where adequate fine fuels were present. Thornber (1910) attempted to document this evidence, "That such fires burning over the mesas and foothills have not been uncommon in times past may be judged by the fact that in many places abundant remains of charred stumps of at least 10 years duration are frequently met with." Wooton (1916) commented on fires severe enough to kill woody plants 10-12 feet tall.

When examining the role of fire in desert grasslands, it is necessary to consider all biological and environmental factors operating simultaneously on this ecosystem. For example, seedlings of mesquite and other shrubs sprout most vigorously following years of abundant fall precipitation (Wright et al. 1976). However, grassland fires were common during the dry seasons following 1-2 years of average to above average rainfall because of improved fine fuel loads and continuity. Therefore, a high percentage of invading shrub seedlings could have easily been killed by fire. For those areas that escaped fire, competition from healthy grasses would substantially reduce the number of woody plant seedlings. Vigorous perennial grasses compete strongly with mesquite seedlings (Martin 1975, Wright et al. 1976). Experiments on the Santa Rita Experimental Range showed that 16 times as many mesquite seedlings were established on bare areas as in vigorous stands of perennial grasses (Glendening and Paulsen 1955). Wright et al. (1976) found similar results in Texas with no surviving mesquite seedlings in a healthy stand of tobosagrass. Even if shrubs become established in a vigorous stand of perennial grasses, their growth rate is slowed substantially compared to shrubs growing among grasses in low vigor. Competition with healthy grasses is a key factor in suppressing shrub densities and growth.

Frequent drought, insects, diseases, rodents, and jackrabbits would have also taken their toll on young mesquites and other shrubs. In areas that escaped fire for 10-20

¹ Much of the text included in this section is from Wright, H. A., and A. W. Bailey. 1982. *Fire Ecology: United States and Southern Canada*. John Wiley and Sons, New York. 501 pp.

years, these factors could have kept young invading shrubs suppressed to less than ½-inch in diameter. A fire at this time would kill approximately half of the invading shrubs (Glendening and Paulsen 1955) and would have kept most of them in a non-seed-producing state. Thus, several factors interacting together, with the help of fire and no grazing by domestic livestock, could have kept shrubs out of the southern desert grasslands.

Overgrazing was promoted by forest administrators in Arizona during the early 1900's to reduce fire hazard and promote the growth of trees. This practice helped to prevent wildfires and allowed brush to invade the grasslands (Griffiths 1910). Overgrazing in desert grasslands, especially during drought, had a similar effect (Chew and Chew 1965). Griffiths (1910) and Leopold (1924) concluded that before 1880 when livestock production became prevalent, the southern desert grasslands produced more grass and that fires occurred at approximately 10-year intervals. The dry-season wildfires temporarily reduced grass densities, but without livestock grazing the grasses recovered quickly (2-5 years). Ten years after a fire, enough fine fuel had accumulated to support another fire – a fire capable of suppressing or killing woody seedlings that had begun to invade the grassland. The relatively poor seed production, slow establishment, and slow growth rate of shrubs would have permitted their control with a fire about every 10 years. The key to preventing shrub invasion of productive grasslands seems to be periodic fires, frequent enough to prevent seed production by shrubs. Creosotebush shrubs do not produce seeds until they are at least 13 years old, and significant numbers of fruit appear only after 18-20 years of growth (Chew and Chew 1965). With competition from biotic and abiotic factors, mesquite may also have taken this long to produce seed.

Today, grazing by domestic livestock is the greatest barrier to the potential use of fire in desert grasslands, especially in black grama ranges. Grazing has reduced fine fuels for fires and allowed shrubs to invade (Chew and Chew 1965, Martin 1975). In addition, grazing too heavily or too soon after fire can prevent the recovery of grasses that is needed after wildfire or prescribed burns. There currently are opportunities to use prescribed fire in desert grasslands to prevent further shrub invasion and, to some degree, reverse the trend. In many areas of the Trans-Pecos, however, a major reclamation program involving brush control, light stocking rates, and grazing deferment would be required to restore desert grasslands before fire could be introduced into a management program. The most common application of fire in the Trans-Pecos today is in tobosagrass and sacaton flats.

Benefits of Fire

In the past, wildfire and a few poorly planned and executed prescribed fires have received considerable public attention. These fires have been blamed for “destroying forests” or “destroying prairies.” Fire does not destroy the land – it only causes changes in the vegetation community. Historically, rangelands in Texas evolved under periodic grazing (nomadic herds of bison, elk, pronghorn) and periodic wildfire. The exclusion of fire from rangeland ecosystems eventually will lead to a decline in the overall health and

diversity of those plant communities.

Because range plants evolved under a pattern of grazing and fire, they are adapted to periodic top-removal. In fact, most plants subjected to periodic top-removal through grazing or fire are more vigorous and productive than those that are “protected”. Removing old growth and litter build up from bunchgrasses helps increase production of new leaves, which are necessary for replenishing the roots with starches and carbohydrates through photosynthesis. Other benefits of fire include increased palatability of forages, a temporary (2-4 months) increase in plant nutrients (fertilization effect), and the suppression of undesirable woody plants.

Livestock benefit from increased nutrient content of forage, improved accessibility to the re-growth, and reduced grazing effort and energy expenditure. Wildlife benefits include healthy diverse plant communities on a large scale and at various stages of growth that provide food and cover.

Rangeland fires in early winter stimulate the production of cool-season annuals and perennial forbs, including a group of plants referred to as “legumes” (pea family). This includes plant species such as Illinois bundleflower, Texas snoutbean, wild bean, pine deervetch, and black dalea. Most legumes are highly preferred by deer and contain high levels of crude protein and various other key nutrients. Most legumes are extremely valuable to upland birds such as scaled quail in that they are some of the best seed-producers. Perhaps even more important, legumes and other forbs attract an abundance of insects. The presence of insects can mean the difference between a “boom or bust” year for upland gamebirds and wild turkeys. Quail and turkey hens rely upon insects for protein and calcium, and insects can be an important water source for quail hens just prior to and during nesting. The young chicks are solely dependent upon insects for food during their first few weeks of life.

Periodic fire tends to promote seed germination and growth of perennial bunchgrasses and favors them over less desirable “invader” species of grasses, forbs, and shrubs. Increased perennial bunchgrasses translates to increased forage production for livestock, improved quality of nesting cover, and improved hiding cover for deer and antelope fawns.

The most beneficial burning programs for wildlife incorporate a multi-year rotation so that 10-15% of the property is burned each year. This schedule will allow 7-12 years between burns for any given area. For larger properties, it is more beneficial to burn several smaller blocks rather than one large block each year. This pattern is especially important in grass monocultures that are often found in Conservation Reserve Program (CRP) acreages. The freshly burned blocks can provide good brood habitat for upland birds and turkeys, as well as high quality grazing for deer or pronghorn. During the following year, these blocks will provide excellent nesting cover for upland birds. The blocks with 2 or 3 years growth will serve as nesting cover and escape cover for birds and as potential fawning grounds.

Effects of Fire on Vegetation

The effects of fire on vegetation are often evaluated by land managers within a year after the fire. However, vegetation changes occur very gradually in arid regions like the Trans-Pecos because plant growth and reproduction is relatively slow. Vegetation changes caused by lack of fire and/or improper grazing occur over decades. Likewise, effects of fire on vegetation types must be evaluated over a period of years rather than months. Although immediate impacts can be important (e.g., forb production), habitat improvement in the Chihuahuan desert is a gradual and long-term proposition.

The growth stage of forbs at the time of the burn can have a substantial effect on the current and following year's production. Forbs are prolific seed producers, but an untimely burn can reduce forb reproduction and wildlife food. This situation normally is not a concern in the Trans-Pecos because when forbs (and grasses) are green and growing, the vegetation usually will not "carry" a fire. Prescribed burns conducted in early to mid-winter with good soil moisture promotes late winter annuals and allows rapid recovery of perennials. A late winter burn conducted after many annual forbs have germinated will reduce their abundance.

Perennial grasses are well-adapted to periodic top-removal by fire. The growing points during dormancy are located near or below the soil surface, and perennial bunchgrasses are deep-rooted. This allows them to recover faster than most other classes of vegetation following a fire and to take advantage of the reduced competition. Annual grasses may be killed by fire after they germinate but may be promoted if burning occurs before germination. The differences in growth cycles between warm and cool season grasses allow the timing of a burn to enhance one class over the other. For example, a late winter fire favors the production of perennial, warm season grasses. Most semi-desert fires result in a short-term (1st year) reduction in perennial grasses. The vast majority of fires result in a greater density and biomass of perennial grasses within 2-3 years after the burn, especially if rested from grazing. Of course, the timing and magnitude of the grass response will be dictated by rainfall conditions during the first few years after the fire. Invader grass species such as annual threeawns are easily damaged by fire. Plains lovegrass, sideoats grama, blue grama, hairy grama, tobosagrass, cane bluestem, little bluestem, Arizona cottontop, and tanglehead all respond well to fire. Vine-mesquite tends to increase in sacaton communities that are burned in winter. Black grama seems to recover from fire more slowly than any other southern desert grass. Drought following fire will lengthen the recovery period for black grama (Nelson 1934, Reynolds and Bohning 1956), and if drought is compounded with moderate grazing, black grama may never recover to its preburn basal area (Canfield 1939). If black grama ranges are burned, they should be rested for 2 consecutive years of average or above average summer precipitation. Then if grazing is resumed, stocking rates should be light.

Most species of cholla, prickly pear, and other cacti are damaged by fire, but most cactus plants recover quickly, especially following fires of low severity. Moderate to severe fires produce relatively high mortality rates on cacti, except for plants isolated

from fine fuels. Barrel and hedgehog cacti are susceptible to fire, with documented mortality rates exceeding 60%. Average mortality rates for cholla are approximately 50%, while prickly pear is slightly less susceptible with kill rates averaging about 30%. Prickly pear mortality rates are highly variable and may range from 20-80%. These mortality rates include the interactive effects of fire, insects, disease, and post-fire grazing by livestock, deer, javelina, and rabbits. Cholla and prickly pear usually do not recover from intense fires for at least 13 years (Cable 1967). Sotol is reduced by moderate to severe fires (30-70% mortality) and lechuguilla is severely reduced by fire when growing among fine fuels (up to 80% mortality).

Non-sprouting shrubs are easily killed by fires, even if the foliage is not consumed. However, the vast majority of woody species in the Trans-Pecos are “sprouters,” meaning that they sprout from a bud zone at or below the soil surface after being top-killed. These shrubs are difficult to kill with a low severity fire, especially after they grow beyond the seedling stage. Shrubs in the Trans-Pecos are much more susceptible to an intense fire occurring in the warm season (e.g., May or June), particularly if they are stressed from drought.

A number of woody species in the mixed shrub community (Chihuahuan scrub) may become so dense that they create problems for livestock production and certain wildlife species. However, the woody species that are most often a problem for landowners in the Trans-Pecos are redberry juniper, honey mesquite, creosotebush and tarbush. Saltcedar is a “problem species” along the Pecos River, the Rio Grande, and along some other permanent bodies of water.

Redberry juniper is difficult to manage with fire unless the bud zone (sprouting region) is above the ground. A mortality rate of 60-80% can be expected as long as this condition exists. The period of time that the bud zone is above ground is determined by the soil site. For shrubs growing on shallow, rocky soils, the bud zone will usually migrate beneath the soil within 10-15 years. Bud zones on shrubs growing in deep soils may grow beneath the soil surface within 8 years. Mature stands of juniper are difficult to manage with fire because of the lack of fine fuel on these sites. In this situation some of the trees must be dozed or grubbed and left to dry for a year. This will provide additional fuel for a hotter fire that will help to ignite the crowns of the remaining trees. When burning a mature stand of juniper, firebreaks should be at least 300 yards wide and numerous “spotters” should be on-site to watch for burning material that may be lifted and transported as far as 1,000 feet. If a mature stand of junipers is successfully burned, a burning plan should be developed that provides for another fire in 7-12 years or before the seedlings are more than 4-5 feet tall.

Honey mesquite is moderately affected by fire, depending upon its age, the number of dead basal stems with insect borer activity, weather at time of burning, and the amount of fine fuel. Unless very young, green mesquite trees are very hard to kill with one fire. Young seedlings that are 1.5 years of age can be killed with a hot fire. Saplings that are 2.5 years old are severely harmed and often killed, but shrubs 3.5 years old are fairly resistant to fire. After mesquites have invaded a site and begun producing seed, it may

not be possible to completely control them with fire. But fire can be an important tool in reducing mesquite densities, plant height, seed production, and future encroachment of this shrub. Studies have shown that plants that have been previously top-killed with herbicide, fire or drought are more susceptible to fire mortality.

Tarbush is a desert shrub that tends to occupy range sites in relatively pure stands or as a co-dominant with creosotebush. Tarbush is part of the desert shrub community that often invades grasslands (primarily tobosa) following many years of heavy grazing but especially in the absence of fire. This shrub can be controlled easily during the initial stages of shrub encroachment (young plants and adequate fine fuels). It is much more difficult to manage mature stands of tarbush that lack adequate fine fuels to carry a fire. Herbicide treatment (tebuthiuron) may be effective in reducing shrub competition and promoting sufficient grass production to carry a fire 3-5 years post-treatment. Mechanical treatment (aerator, chisel, heavy disc) is probably more effective in promoting the growth of fine fuels (grass) by reducing shrubs and improving rainfall infiltration. On sites supporting low to moderate fine fuels, grazing deferment and periodic fire can be used to effectively manage tarbush shrubs.

Creosotebush is similar to tarbush in that it can be managed with fire under certain conditions. The amount of damage to creosote shrubs is dictated by the fuel load, air temperature, humidity, age of the plants, and season of the burn. Shrubs will resprout if the root crown is not killed by the fire. Cool-season fires usually only top-kill mature creosote shrubs, but may kill a relatively high percentage of young plants. Warm-season fires kill a much greater proportion of shrubs than cool-season fires. Intense fires, particularly in June and July, can produce mortality rates that approach 100% (Brown and Minnich 1986, White 1968, White and Ehrenreich 1968). A common problem occurring in mature stands of creosote is the lack of fine fuels to carry a fire. Mahall and Callaway (1991) suggest that root-mediated allelopathy prevents other plant species and possibly even creosote seedlings from establishing between mature creosote shrubs. Soils under some creosote shrubs tend to be water repellent because of associated soil microorganisms (Adams et al. 1970). This hydrophobic condition, along with soil loss, prevents the establishment of herbaceous plants that could serve as fine fuels for a fire. Mechanical treatment provides the greatest potential for reducing shrub competition and improving soil hydrology for grass restoration and the implementation of fire as a management tool.

Recommendations for Prescribed Burning:

Land managers attempting to use prescribed fire as a management tool should have a fire plan prepared by the local County Extension Agent, Natural Resource Conservation Service, or TPWD Biologist. The plan should include landowner objectives, desired weather conditions, equipment arrangements, personnel considerations, firelane installation, and grazing management considerations (pre- and post-burn). The local fire departments, law enforcement officers and neighbors in the immediate area should be notified prior to the burn date.

General Recommendations for a Cool-season Prescribed Fire:

Relative humidity of 30% to 50%
Wind speed of 5 to 10 miles per hour
A minimum fuel load of 1,200 lbs. per acre
Temperature 60 to 70 degrees

Prescribed burning under the weather conditions listed above will result in a relatively "cool fire" and will not top burn desirable trees.

Burn in late December or early January for maximum forb growth.
Burn in late February or March to improve grass quality and species composition.
For highly erodible soils, burn as late as possible in the dormant season to allow a quick green up and lessen the possibility of soil erosion.

The backfire should be burned with 40% to 50% relative humidity. Before setting the headfire, the blackline should be at least 100 yards wide for grass fires and at least 300 yards wide for brush pile fires.

Avoid conducting prescribed fires when temperatures are greater than 80°F., when the relative humidity is lower than 20%, and when wind speeds exceed 20 miles per hour. These are wildfire conditions -- the topping of trees by fire will probably occur and the chances of fire escape increases substantially. An exception to this rule is appropriate when a prescribed burning plan specifically requires a very intense fire for the control of certain woody species (although high winds are undesirable). However, burning under severe weather conditions requires a very experienced fire boss and crew.

Literature Cited

Adams, S., B. R. Strain, and M. S. Adams. 1970. Water-repellent soils, fire, and annual plant cover in a desert scrub community of southeastern California. *Ecology* 51: 696-700.

Brown, D. E., and R. A. Minnich. 1986. Fire and changes in creosotebush scrub of the western Sonoran Desert, California. *The American Midland Naturalist* 116: 411-422.

Cable, D. R. 1967. Fire effects on semidesert grasses and shrubs. *J. Range Manage.* 20: 170-176.

Canfield, R. H. 1939. The effect of intensity and frequency of clipping on density and yield of black grama and tobosagrass. *USDA Tech. Bull.* 681. Washington, D. C.

Chew, R. M., and A. E. Chew. 1965. The primary productivity of a desert-shrub (*Larrea tridentata*) community. *Ecol. Monogr.* 35: 355-375.

Glendening, G. E., and H. A. Paulsen, Jr. 1955. Reproduction and establishment of velvet mesquite as related to invasion of semidesert grasslands. *USDA Tech. Bull.*

1127. Washington, D. C.

Griffiths, D. A. 1910. A protected stock range in Arizona. USDA Bur. Plant Indus. Bull. 177.

Washington, D. C.

Humphrey, R. R. 1958. The desert grassland. Bot. Rev. 24: 193-253.

Leopold, A. 1924. Grass, brush, timber and fire in southern Arizona. J. For. 22: 1-10.

Mahall, B. F., and R. M. Callaway. 1991. Root communication among desert shrubs. Proceedings, National Academy of Sciences 88: 874-876.

Martin, S. C. 1975. Ecology and management of southwestern semidesert grass-shrub ranges: The status of our knowledge. USDA For. Serv. Res. Paper RM-156. Rocky Mtn. For. and Range Exp. Stn., Fort Collins, Colo.

Nelson, E. W. 1934. The influence of precipitation and grazing upon black grama grass range. USDA Tech. Bull. 409. Washington, D. C.

Reynolds, H. G., and J. W. Bohning. 1956. Effects of burning on a desert grass-shrub range in southern Arizona. Ecology 37: 769-777.

Thorner, J. J. 1907. 18th Annual Report. Ariz. Exp. Stn., Tucson.

Thorner, J. J. 1910. Grazing ranges of Arizona. Pages 245-360 in Univ. of Ariz. Agric. Exp. Stn. Bull. Tucson.

White, L. D. 1968. Factors affecting susceptibility of creosotebush (*Larrea tridentata*) to burning. Ph.D. Diss. Univ. of Ariz., Tucson.

White, L. D., and J. H. Ehrenreich. 1968. Factors affecting susceptibility of creosotebush to burning. Abstr. of Papers, Amer. Soc. Range Manage., Albuquerque, N. Mex., pp. 51-52.

Wooton, E. O. 1916. Carrying capacity of grazing ranges in southern Arizona. USDA Bull. 367. Washington, D. C.

Wright, H. A., S. C. Bunting, and L. F. Neuenschwander. 1976. Effect of fire on honey mesquite. J. Range Manage. 29: 467-471.

APPENDIX G

Specific Management Recommendations for Mule Deer

Mule deer are one of the most valued game animals in the Trans-Pecos region of Texas. Whether it's their limited distribution, low numbers, or their unique appearance and behavior, most landowners view mule deer as a precious resource. Many landowners have recognized mule deer as a financial asset and have capitalized on this value through lease hunting.



Other landowners choose not to lease and some do not allow hunting, and yet almost all closely protect this resource.

Mule deer differ from white-tailed deer in many respects. Because of the tremendous amount of information available concerning white-tailed deer management, many landowners have applied these management techniques to mule deer herds with inconsistent results. Therefore, it is important to implement management practices that are specific to mule deer.

One of the most important factors influencing the health and productivity of a mule deer herd is the quantity, quality, and variety of food plants produced by the habitat or range. Food availability can be improved by : (1) harvesting deer, including does where applicable, to maintain total deer numbers at or below the capacity of the habitat, (2) preventing competition with exotic big game (eg., Aoudad sheep) for forage by eliminating them or reducing their numbers, (3) using compatible kinds/classes of livestock (i.e., cattle) at light or moderate stock densities, (4) using a deferred-rotation grazing system, (5) and controlling invading woody vegetation (e.g., cedar and mesquite) where densities exceed optimum cover requirements for mule deer.

HABITAT REQUIREMENTS

Deer Foods and Deer Diets

Whether a mule deer herd is managed for quality antler production or high deer

numbers, nutrition is the most important factor to consider. Deer require a diet of approximately 16% protein along with carbohydrates, fats, vitamins, and a variety of trace minerals. No single forage provides adequate levels of all these requirements, which emphasizes the importance of managing for a wide variety of foods. The Trans-Pecos has a tremendous diversity of vegetation types that can provide excellent nutrition for mule deer, especially when rainfall is adequate.

Deer are extremely selective feeders, eating a wide variety of the most nutritious foods available during each season of the year. Food plants can be classified as shrubs/succulents, forbs and grasses. The leaves, twigs, buds, and blooms of woody plants eaten by deer are called browse. Succulents like cactus, lechuguilla, and cholla are often included in this category. Water obtained from these succulents is important, perhaps critical, especially if free water is not available in semi-arid and arid areas.

The bulk of mule deer diets (70%) consists of browse. Key browse plants in the Trans-Pecos include kidneywood, acacias, netleaf and sugar hackberry, oaks, littleleaf sumac, skunkbush sumac, four-wing saltbush, mountain mahogany, Apache plume, bernardia, foresteria, mesquite, littleleaf lead tree, sotol, and juniper. Mast (fruits) of woody species can be seasonally important, and they generally are good sources of energy.

Forbs are annual or perennial broadleaf plants and are highly preferred by deer when available. Although their availability is highly variable and largely dependent on environmental conditions, forbs average about 25% of a mule deer's diet. Annual forbs are seasonal; therefore, perennial forbs provide a more reliable source of forage, and should be present on properly managed ranges. Some of the more important perennial forbs used by mule deer include menodora, golden eye, long stalk greenthread, bluets, bladder-pod, Engelmann daisy, and spiderwort.

Abundant throughout the Trans-Pecos, native grasses are not a preferred mule deer food and usually represent no more than 5% of most mule deer diets. Although not important on an annual basis, tender grass shoots may be very important on a seasonal basis during brief periods when other forage is unavailable.

Deer nutrition, as it relates to reproduction, is important to the land manager. Successful breeding depends largely upon the doe's health during the rut. The ovulation rate is strongly affected by the doe's level of nutrition and physical condition just prior to and during the rutting period. The doe's nutritional condition during gestation has an effect upon the size and survival of fawns at birth.

Cover

Woody plants are important to mule deer in providing shelter from weather extremes, escape from predators and hunters, and security cover. They are also a key food source; however, woody cover can become too dense for optimum mule deer habitat, can reduce forage production, and create livestock management problems. Brush management can be beneficial or detrimental to mule deer, depending on how it

influences food and cover.

In many areas where the height and density of brush is increasing, the habitat is becoming more suitable for white-tailed deer and less desirable for mule deer. Research indicates that mule deer prefer a brush canopy cover of 40% or less, while white-tailed deer showed positive population responses with brush canopies exceeding 50%. Brush density and canopy are important considerations when managing mule deer habitat.

Water

Water is a critical component of mule deer habitat in the Trans-Pecos. Studies of mule deer water requirements indicate that their home range is closely associated with permanent water sources. Research has shown that mule deer numbers increased significantly in habitats where permanent water was developed. In areas where water sources deteriorated, a concurrent reduction in deer numbers occurred.

The tendency for mule deer and livestock to congregate around permanent water sources often results in excessive use of forage plants in the surrounding area while other areas receive little use. This can be corrected by distributing water sources throughout the deer herd's range. Permanent water sources should be no greater than 2.5 - 3 miles apart.

POPULATION MANAGEMENT

Mule deer management is sometimes viewed as two separate phases: Habitat management and population management. Habitat management primarily involves the manipulation of food, water, and cover to improve deer nutrition and survival. Population management manipulates deer numbers, sex ratio, age structure, and genetics. In reality the two "phases" are inseparable. The habitat quality has a direct influence on deer numbers just as excessive deer numbers can impact habitat quality.

Population management is similar to conducting a business. You must first inventory the product (census), then sell the product (harvest), and keep records (age, weight, antler measurements) to evaluate management decisions. This process allows the manager to determine the deer herd status at a given point in time, as well as evaluate the herd trend over a period of years.

Deer Surveys

A deer survey provides an estimate of the number of deer occupying a range, but more importantly, it provides an indication of trend in deer numbers over a period of years.

The most commonly used technique for surveying mule deer is the spotlight survey. After an appropriate route is determined, the route is driven after dark and deer are counted with the aid of spotlights. Visibility estimates are taken to calculate the area

observed during the survey. Based on the area observed and the number of deer observed, a density estimate can be produced (acres per deer). Because it is critical to proportionately sample all available habitat types, this technique may not be applicable on ranches with limited road systems.

Helicopters can be used to conduct a partial or total ranch survey for mule deer. This technique allows the manager to estimate deer density, herd composition, and buck quality in a relatively short period of time. However, research has shown that only 35 - 85 % of the deer on a ranch are actually observed from a helicopter, depending on terrain and canopy cover.

No survey method is 100 percent accurate; however, either of the two methods described can provide valuable information on deer numbers and herd composition trends. The manager must choose the most appropriate survey method by considering ranch size, vegetation, terrain, finances, management objectives, available manpower, and time constraints. Refer to **Appendix I** for a more detailed discussion of deer survey methods.

Harvest Management

A basic tool in the management of a mule deer herd is a regulated harvest during the hunting season. The appropriate harvest level and resulting age-class distribution in the herd depend largely on the manager's objective. Mule deer tend to be more susceptible to hunter harvest than white-tailed deer because mule deer inhabit more open terrain and are more hesitant to flee than whitetails. This vulnerability to harvest, combined with lower reproductive rates and periodic drought-related die-offs, result in the potential for over harvest of a mule deer herd. This is especially true in areas where fawn recruitment is low.

Except in very limited areas of the Trans-Pecos, mule deer hunting is for bucks only. The harvest of doe mule deer is carefully regulated through the issuance of antlerless deer permits. Protection of the doe segment of the herd is often necessary to offset low fawn recruitment rates.

With the relatively low harvest rate of bucks and the control maintained by most landowners, hunting is rarely detrimental to mule deer populations. However, the suppression of mule deer populations through harvest has been documented in areas where many small land tracts exist. The best alternative in this situation is to form a landowner cooperative and manage the deer herd in a group effort, with strict enforcement of harvest limits.

Improving antler size of mule deer bucks requires a harvest strategy which allows them to reach maturity (5 1/2 to 7 1/2 years of age). This can generally be accomplished by restricting the harvest to 10-15% of the estimated buck population.

The appropriate buck:doe ratio for mule deer depends on overall herd numbers, relative

to the carrying capacity of the habitat, and fawn survival rates. A 1:3 buck:doe ratio is desirable for mule deer when fawn production and survival is relatively low. In areas where natural mortality is high and deer densities are low, a higher number of does may be needed to maintain or increase the population. Doe harvest is appropriate when a herd has exceeded the carrying capacity of the habitat, but doe harvest should not be used to improve a skewed buck:doe ratio (e.g., 1:4, 1:5, or greater).

Harvest Records

Harvested deer provide an excellent opportunity to collect biological information as well as valuable answers concerning harvest strategies, harvest rates, nutrition, and management decisions. Information collected should include age, field-dressed weight, antler measurements, and body condition. This information, when combined with annual survey information, can be used to guide habitat management decisions and adjust harvest rates.

SUMMARY

The key to mule deer management is habitat management. Successful managers are aware of deer requirements for food, cover, water, and understand how management practices impact these requirements. Providing adequate food for mule deer means balancing the forage supply with animal numbers, which includes both deer and livestock. Because of the generally low fawn recruitment rates, providing adequate hiding cover for fawns can be the difference between success and failure in a management program. The primary tools available to the manager for enhancing mule deer habitat are grazing management, brush management (including prescribed fire), and water development.

For more information, see PWD Booklet W7100-303 Mule Deer Management in Texas (1997) by R. Cantu and C. Richardson (22 pp.)



Specific Management Recommendations for White-tailed Deer

Introduction

The white-tailed deer in west Texas is a species that attracts a wide range of opinions. Many landowners, protective of their prized mule deer herds, resent the “invasion” of the white-tailed deer into areas previously unoccupied by the “lesser species.” Others view the white-tailed deer as an additional source of recreation (hunting, photography, observation, etc.) and/or income.

The western Edwards Plateau (Reagan, Crockett, Terrell, and eastern Pecos counties) supports relatively high numbers of white-tailed deer, a direct result of intensive predator control associated with the sheep and goat industries. High numbers of deer and livestock, combined with limited precipitation, commonly result in small-bodied, modest-antlered deer. However, on a few properties where animal numbers are kept below carrying capacity, a year of average rainfall can produce some impressive white-tailed bucks (especially in the deeper soils of the Permian Basin).

Deer Diets and Nutrition

Understanding the food habits of deer is fundamental to their management. Numerous diet studies have shown that deer prefer forbs (weeds) and browse (leaves, twigs, and buds from woody plants). Grasses make up a very small portion of a deer’s diet, and they will use them only when they are tender and green (they are unable to digest mature grasses). Forbs are relatively high in protein and minerals and are highly digestible (~80%), but the production, quality and palatability of forbs is highly dependent on rainfall and season of year. This is especially true of annual forbs. Some important perennial forbs are bushsunflower, showy menodora, wild bean, prairie acacia, penstemon, dayflower, bundleflower, snoutbean, chickthief, milkwort, trailing ratany, gaura, spiderling, and Angel trumpet. Although lower in digestibility on average (~50% digestible), browse is a more reliable source of nutrition during drought. Key browse plants occurring in west Texas include guayacan, hackberry, kidneywood, elbowbush, bernardia, desert ceanothus, littleleaf leadtree, Roemer acacia, butterflybush, feather dalea, evergreen sumac, littleleaf sumac, lotebush, narrowleaf foresteria, and various oaks (especially red oaks). Important mast (fruit) producers include mesquite, Texas persimmon, acacias, prickly pear, and oaks. Succulents such as lechuguilla, sotol, tasajillo, prickly pear, and yucca can be important to deer in west

Texas during drought for subsistence-level nutrition and as a water source.

HABITAT MANAGEMENT

Grazing Management

The most important factor influencing deer habitat in west Texas is the number of grazing and browsing animals (deer and livestock). Not only is livestock grazing prevalent throughout the region, but it has a direct impact on the quantity and quality of food plants, fawning cover, and to some extent, on woody cover. Grazing can be beneficial or detrimental to deer habitat, depending on numbers and kinds of livestock, grazing method, season of use, and grazing distribution.

All of these livestock grazing variables are important management considerations, but the overriding influence on habitat quality is livestock numbers. Regardless of the type of livestock or the grazing method, too many animals of any kind (including deer) will result in range deterioration and a reduction in food and cover for deer and other wildlife. Overgrazing obviously has a direct impact on the health and survival of individual deer; but more importantly, it probably will result in a long-term reduction in carrying capacity of the range and productivity of the herd. (Carrying capacity is the number of animals that a habitat can support without causing resource deterioration).

The kind of domestic animals that are grazed can greatly affect habitat characteristics, especially the availability of deer foods. Under light stocking rates, competition for forage between deer and livestock is minimal. Even under moderate stocking rates, there is very little competition between deer and cattle because the plants preferred by deer are seldom used by cattle (although there can be a substantial effect on fawning cover). Cattle primarily eat grass (85-90%) and occasionally use forbs and browse. Deer prefer forbs and browse with very light use of grasses. Although grasses may represent up to 20% of a deer's diet in early spring, grasses represent only 5-7% of the diet on an annual basis. On an overgrazed range, competition between cattle and deer for forbs will increase as the quantity and quality of grasses decline.

Keep in mind that during extended drought, a moderate stocking rate operates like a heavy stocking rate with regard to plant health and soil stability.

Competition for food becomes more of a concern when sheep and/or goats are present. Sheep primarily eat forbs and grass and thus will often compete with deer for forbs. The greatest diet overlap occurs between deer and goats (especially Spanish goats), both preferring browse and forbs. The range condition will have a direct effect on diet overlap among different kinds of animals. Overlap will be greatest in pastures that have a low diversity of forage plants.

Grazing methods or "systems" can also have a substantial impact on deer habitat. Grazing methods generally fall into one of two categories, continuous or rotational (See Appendix D – Livestock Grazing Management for the advantages and disadvantages of

various grazing systems).

Brush Management

Woody plants (brush) provide escape cover, loafing cover, thermal protection, and food (browse and mast) for white-tailed deer. However, there are instances when brush densities exceed optimal habitat requirements and preferences of deer. Excessive brush densities can hinder movement, reduce visibility of approaching danger, reduce herbaceous forage by competing for moisture and nutrients, and can promote increased predator populations. Brush thickets can present similar management problems concerning livestock. In such instances, a land manager may want to consider some method of brush management as an option for improving livestock management and habitat quality for deer and other wildlife species. However, managers should avoid excessive removal of woody cover because inadequate cover can be just as detrimental as too much brush.

Several brush management options are available to help accomplish deer management objectives. Most of these options fall into 3 categories: herbicides, prescribed fire, and mechanical treatments (See Appendix E – Recommendations for Brush Management in West Texas for detailed information).

Providing Supplemental Nutrition

The questions most frequently asked by deer managers regarding supplemental feeding are “What should I feed?” and “How much should I feed?” A more appropriate question would be “Is supplemental feeding an effective management tool?” And for some managers, another important question might be “Is supplemental feeding of deer cost-effective?” That is, does it pay? The answer to the first “appropriate” question is that it can be, if you provide the right kind of feed at the right time of year. The answer to the second question is “probably not.” Feed and labor is extremely expensive, and it is difficult to get the feed into the specific animals that you are targeting. If your goal involves antler development, 70-80% of your feed will be going to non-target animals (does and fawns). Even if your goal involves feeding the entire deer herd, a substantial portion of the feed may be going to javelinas, livestock, raccoons, birds, and small mammals (rats and mice). Non-target loss of feed substantially increases the cost of the feeding program.

Before discussing the details of deer nutrition and feeding, it is important to understand 3 basic facts. Fact #1: Under good forage conditions (when plants are green and growing), deer generally will not take feed and they don’t need it. A diversity of green forage contains all the protein, energy, and minerals they need. Fact #2: Feeding can increase deer numbers, IF you provide enough of the proper nutrients during the appropriate season. Fact #3: Feeding can improve antler quality, IF you provide enough of the proper nutrients to the bucks during the appropriate season (and the bucks consume adequate amounts).

When considering the implementation of a supplemental feeding program for deer, nothing is more important than clearly defining your objective. If your objective is to increase deer numbers, the feeding program must focus on doe conception and fawn survival. Of course, this simple formula assumes that you don't already have too many deer. The nutrition of the doe is important throughout pregnancy, but soon after giving birth, the doe's energy demand doubles. If the does are nutritionally stressed during lactation (late June, July, and August are critical), the result will be lower fawn weights and decreased survival. A high protein/high energy feed can improve fawn survival during a summer drought. During years with adequate fall precipitation, the does can easily recover from the stress of lactation and be in good condition by breeding season (late November). If the late summer and fall period is dry, a good feeding program (moderate protein and moderate energy) can substantially increase conception rates and the incidence of twins vs. single fawns (dictated by doe condition).

If improving antler quality is the goal, a completely different strategy should be implemented. The feeding program must focus on providing adequate protein and minerals during the antler growth period (March – August). Once again, this simple formula is not effective if you have too many animals (deer or livestock) on the range. Protein is extremely important during the first half of antler development, whereas minerals become more important during the latter stages of antler growth. If animal numbers are in balance with native forage, antler quality can be improved by providing a high-protein feed (20%) from February or March through June or July, and then followed by a moderate protein feed (16%). A mineral supplement should be initiated in June if adequate minerals are not present in the feed. Important macro-minerals for antler development and hardness are calcium, phosphorus, magnesium, potassium, and sodium. Important trace minerals are iron, copper, zinc, selenium, and manganese.

Various types of feed or grain are used to bait deer to a particular area during the hunting season to improve hunter opportunity for harvest. This does not constitute a supplemental feeding program. The most commonly used deer "bait" is corn, which is a good source of Vitamin A and an excellent energy supplement. Thus, corn may be beneficial to does during lactation and to the deer herd during winter when carbohydrates are low in native forages. However, corn contains only 7-10% protein and lacks some key minerals that are essential for proper body and antler growth. In a supplemental feeding program, high-protein pellets are superior to corn as a choice for supplemental feed. A desirable pellet formula contains 16-20% protein along with proper amounts of minerals and Vitamins A, D, and E. If an automatic feeder is used, a 3/16-inch pellet size may help to avoid clogging the feeder (mixing with corn or peas may also help). Cottonseed is less expensive than protein pellets and is an excellent source of protein and energy. Cottonseed has the added advantage of being unpalatable to most non-target wildlife species. Cottonseed is relatively low in mineral content; therefore, a mineral supplement (mineral mix or blocks) should be provided, especially during the last 2-3 months of antler growth.

Food plots are another alternative for providing additional year-round nutrition for a deer herd, as well as benefits to various other wildlife species. Food plots have been

successful in many areas of Texas in improving individual deer performance when used with a proper deer harvest program to keep deer numbers balanced with forage. However, in west Texas food plots are usually successful only during years of abundant rainfall. The rangeland forage conditions are normally so good during these years that the plantings are of little value. In the rare circumstance where irrigation is possible, food plots can be extremely valuable. Several scattered food plots 5-10 acres in size, located near existing escape cover, can help to provide quality forage during times of nutritional stress such as winter and late summer. Winter wheat and oats are excellent choices for a cool-season food plot because of their high protein content and digestibility during the early stages of growth. Grain sorghum and alfalfa can be a good combination for a warm-season food plot, especially for managers who are also interested in enhancing quail and turkey habitat.

A supplemental feeding program may be beneficial under certain conditions. In most cases, however, the best way to provide your deer and other wildlife species with adequate nutrition is through proper habitat management and maintaining a balance between livestock and deer numbers and the available forage.

Water Development

Water is a critical component of white-tailed deer habitat in west Texas. On most west Texas ranches, water facilities are adequately distributed and maintained for livestock production. White-tailed deer and other wildlife species are beneficiaries of these livestock watering systems. In areas where permanent water is limited or absent, deer managers can improve habitat use and the land's carrying capacity for deer by developing additional water sources. Studies of white-tailed deer in arid regions indicate that their home range is closely associated with permanent water sources. The tendency for deer and livestock to congregate around permanent water sources often results in excessive use of forage plants in the surrounding area, while other areas receive little use. This situation can be improved by distributing water sources throughout the deer herd's range. Permanent water sources should be no greater than 2 miles apart to promote adequate use of habitat. Establishing water sources approximately 1 mile apart can further improve white-tailed deer distribution on many ranches. Conventional water sources such as windmills and pipeline systems will work for most areas; however, they usually become cost-prohibitive in rough, inaccessible terrain. An effective solution is a water development system for wildlife called a "guzzler." Guzzlers are adaptations of cisterns used in many arid regions to catch and store rainfall. Most rainfall catchment devices are designed to stay recharged with 8 inches of annual rainfall. Water catchment devices can effectively enhance deer habitat if properly located and periodically maintained.

POPULATION MANAGEMENT

Deer management is often described in 2 separate phases: habitat management and population management. Habitat management is the manipulation of food, cover, and water to improve deer nutrition, reproduction, and survival. Population management

refers to the management of deer numbers, sex ratio, age structure, and sometimes genetics. In reality, the 2 phases are not clearly separable. The quality of the habitat has a direct influence on deer productivity and deer numbers. Similarly, excessive deer numbers can affect the quality of the habitat. Although this section devotes considerable attention to the management of deer numbers and herd structure, the foundation of any deer management program is the development and maintenance of quality habitat.

One of the first steps in population management is to determine the status of the deer herd with regard to deer numbers, sex ratios, and fawn survival. This information can be obtained by conducting a deer survey.

Deer Surveys

The reason that deer counts are referred to as “surveys” rather than “censuses” is that it is impossible to obtain an exact count of deer on a property. Instead, surveys provide only an estimate of deer numbers. Estimates are valuable because it is not important to know exactly how many deer are present; it is much more important to know what the **trend** is over time (whether it is the trend in deer numbers or buck quality). There are several survey methods available, and if conducted properly, the estimates can provide a reliable indication of herd trend. Each survey method has strengths and weaknesses, and some methods will suit a particular property better than others, depending on vegetation, topography, the road system, as well as landowner objectives and finances. The two methods most applicable in west Texas are helicopter surveys and spotlight surveys. Refer to Appendix I -- Deer Survey Techniques in the Trans-Pecos Region for detailed information on the advantages and disadvantages of various survey techniques.

Harvest Records

When landowners initiate a deer management program, the manager or biologist often emphasizes the importance of deer surveys, with considerably less emphasis given to recording harvest information. Although surveys are important, often more information for making management decisions can be obtained from harvest records than from any of the survey methods. Records from harvested deer can provide information about the nutritional status of the deer herd, age structure of the herd, proper or improper harvest rates, mortality rates, and if does are harvested, information about fawn survival. The hunting season offers one of the few opportunities for a manager to collect this hands-on information about the deer on his ranch.

Thorough harvest records should include the date of harvest, the ranch, the hunter, age of the deer, field-dressed weight, antler measurements (basal circumference, beam length, inside spread, number of points), apparent body condition, and whether the does are lactating. Some managers also maintain visual records by taking a photograph of each harvested deer, which can later be developed into a useful marketing resource. The percent of does that are lactating can provide a good indication of fawn survival.

Weights, antler measurements, and general body condition are indicators of nutrition. Body condition of deer can be categorized as "good" (fat across the back and base of tail; fat on kidney and in body cavity), "fair" (little or no excess fat, bones not showing), or "poor" (ribs, backbone, and pelvic girdle prominent under skin). But field-dressed weights and antler measurements are of little value without the respective age of the deer. Age-specific information is necessary to determine whether body weights and antler growth is acceptable or below standard for each particular age class.

Age class is important for determining whether the herd is receiving adequate nutrition, but recording the age of deer is important for another reason. The age distribution in the harvest can provide valuable information about the age distribution of deer on the ranch. The harvest will not necessarily reflect the exact age distribution in the population because the type of deer harvested is directly related to the management objectives of the ranch, harvest strategies, and hunter decisions. However, when the majority of bucks harvested are 3.5 years old and less, it suggests that the buck segment is being heavily harvested. Likewise, if the majority of white-tailed does harvested on a ranch are 4 to 7 years old, this indicates that they are, at most, under a very light harvest.

Equipment that may be needed for collecting harvest information are weigh scales, measuring tape, jaw-spreader/remover, flashlight, wash bottle, clipboard, and data sheets. For hunters or managers that are new to the toothwear aging technique, it may be useful to have a jawboard or some other type of reference collection of deer jaws that represent each age class.

Harvest Management

The first step in any deer management program is establishing a set of deer management objectives for the property. The objectives may include a desired deer density, a specific quality-class of bucks with details about antler and body size, and/or more subjective interests concerning the quality of the recreational experience. Whatever the objectives, they will dictate harvest strategies and habitat management needs. Collection and analysis of survey data and harvest records will help the manager determine the status of the deer herd concerning deer numbers, age structure, sex ratio, nutrition, and productivity. With this baseline information, the manager can make informed decisions and develop a harvest strategy that will help to accomplish his/her deer management goals. More importantly, the harvest and survey data can be used to evaluate progress toward deer management goals and to adjust harvest strategies and other management practices on an annual basis.

Sex Ratio

There is no such thing as a "perfect" sex ratio. The appropriate buck to doe ratio for a given property will be dictated by manager objectives, fawn production, and natural mortality rates of adult deer. That is, the sex ratio is a product of proper management and the population dynamics of a particular deer herd. There is tremendous energy

expended by some managers who attempt to shift the sex ratio to some preset “target” ratio. When a manager establishes a particular sex ratio as a management goal without consideration for the population dynamics of the local herd, they often will be working against nature rather than working in concert with the natural conditions of the property.

Some ranches strive to achieve a 1:1 buck to doe ratio, using the logic that there are more bucks available for harvest. This may be true at a given point in time, but more bucks can be harvested over a period of years with a slightly higher number of does or “producers” (e.g., 1:1.5 or 1:2). To illustrate this point, let’s look at an example of 2 livestock operations. Which rancher will produce more bull calves in the long-run – the one running 20 bulls to 20 cows or the one running 3 bulls to 40 cows?

Rancher #1

20 bulls: 20 cows

(Assuming a 90% calf crop and 1 animal unit/cow and 1.2 animal units/bull)

18 calves per year

Approx. 9 bull calves/year

Rancher #2

3 bulls: 40 cows

36 calves per year

Approx. 18 bull calves/year

Similarly, which deer manager will produce more buck fawns in the long-run – the one with 100 bucks and 100 does or the manager with a 1:2 buck to doe ratio? A 1:2 buck to doe ratio will produce about 33% more buck fawns each year. To achieve and maintain a 1:1 ratio on most ranches, the manager must harvest the doe segment very intensively. Therefore, this strategy is only practical on ranches with relatively high fawn survival. The other requirement in maintaining a 1:1 ratio is a very conservative buck harvest. The usual result is a relatively high rate of natural mortality among the bucks. Many of these are mature bucks that could have otherwise been harvested. This buck production argument does not take into account the other negative factors associated with a 1:1 ratio such as antler breakage and buck mortality from excessive fighting. Finally, there is the misunderstanding that buck and doe numbers can be “traded” equally when moving the sex ratio toward an “even” ratio. More forage is required to support a 170 lb. buck on an annual basis than a 100 lb. doe. That is, a pasture that can support 100 does and 40 bucks can not support 70 does and 70 bucks on the same nutritional plane.

For the deer manager interested in producing quality bucks, the management formula is simple. Harvest no more than 15-20% of the buck segment annually, and control deer numbers through doe harvest. The higher the fawn crop, the higher the resulting adult sex ratio (e.g., 1:1.5). The lower the fawn crop, the lower the resulting adult sex ratio (e.g., 1:2). This is only logical because fewer (if any) does need to be harvested when fawn survival is low. The result of this simple strategy will be a sufficient number of bucks in the mature age classes and a sex ratio that is appropriate for your objectives and your country.

Spike Bucks and Culling

How does the issue of spike-antlered bucks and culling fit into the harvest management equation? This is an interesting question, but unfortunately deliberation over this issue has often been responsible for depreciating more important practices such as habitat enhancement, reducing animal numbers, and improving the herd age structure. The question of whether or not to cull spike bucks for genetic improvement is a valid consideration only on ranches with good to excellent deer habitat, moderate animal numbers (deer and livestock), and a mature age structure among the bucks.

Antler growth and development are dependent on the combined effect of nutrition, age and genetics. The ability of a buck to express its genetic potential for antler development is dependent on obtaining adequate levels of protein, carbohydrates, fats, vitamins, and minerals. Inadequate nutrition will result in decreased antler mass and usually the number of points. Many 1½ year old spike bucks have the genetic potential to produce 6 or 8 points as yearlings; however, they fall short not only in antler development but also in body growth because of inadequate nutrition. Most of these deer are capable of producing quality antlers in subsequent years, provided they obtain adequate amounts of the essential nutrients.

On the other hand, there are deer that will produce spike antlers at 1½ years of age regardless of the diet quality they obtain. Some of these deer may produce spikes in subsequent years, a few will eventually develop quality antlers when they reach maturity, but most will produce forked antlers at maturity that have slightly fewer points and less mass than the average buck. Some managers refer to these yearling deer as "genetic" spikes (in contrast to "nutritional" spikes).

Spike antlers are relatively common among bucks that were born late in the previous fawning season. The primary factors responsible for an extended fawning season are widely skewed sex ratios (e.g., 1:5 or 1:6) and a malnourished deer herd. The early season fawns may be 4 months older than the late fawns and have a much better chance of developing a decent set of antlers in their first year. In fact, research in Mississippi has shown that it takes several years for these late-season fawns to "catch up" in antler development. However, at maturity there is no difference in antler development between the bucks born early and late in the fawning season. These yearling bucks are sometimes referred to as "lag effect" spikes, in that there is a time lag of several years before they reach their genetic potential.

It should be obvious why the question regarding the culling of spike-antlered bucks can not be answered quickly and simply. When deer managers or hunters ask about culling deer and harvesting spikes because they are dissatisfied with the antler quality, there are several important factors that should be addressed first.

1. Make certain that nutrition is not a problem – not only deer condition in November and December, but year round – especially during antler growth (collect deer weights and antler measurements by age class, monitor fawn crops, conduct forage

surveys, make year-round observations, etc.).

2. Make certain that buck age structure is not a problem – young bucks can be mistaken for poor quality mature bucks (determine ages of harvested bucks).
3. Make certain that a skewed sex ratio is not a contributing problem (annual surveys).

Many deer managers are producing bucks with good antler development (good age structure and good nutrition), but they want to further increase the antler quality through genetic manipulation (culling). This objective involves a question that is much more difficult to answer: “How much improvement on buck antler quality can I expect through culling of spikes and other ‘inferior’ deer?” Superior genetics can produce substantial improvements in the livestock industry, and selection for antler traits has been demonstrated in deer research pens. What might prevent deer managers from accomplishing the same kind of improvements on a large ranch?

There are several reasons why genetic culling of deer may not result in a noticeable improvement in antler quality in a ranch situation. We need to learn more about heritability of antler traits, but data from the only 2 studies that have been conducted indicate that the degree of heritability may be lower than desired to make a significant change in antler traits. Research has shown that the probability is greater for a “quality” buck than an “inferior” buck to produce male offspring with quality antlers. If “degree of heritability” was the only concern, it would be well worth the effort to cull. Unfortunately, there are other factors that dilute the selection effort on ranches.

Depending on the year and resulting forage conditions in west Texas, spikes may represent 20-90% of the yearling age class. From a logistical perspective, it would be very difficult to harvest this number of deer on a large ranch. From a biological perspective, it would be highly undesirable. Very few bucks would ever reach the mature age classes, and this strategy could result in a very skewed sex ratio (1:4, 1:5, or worse). A skewed sex ratio can lead to an extended fawning season and an increased number of spikes (lag-effect).

The vast majority of ranches in west Texas use low fences (net-wire or barbed-wire) that are easily negotiated by white-tailed deer. Unless your neighbors are culling just as intensively as you are and in the same manner, deer movements between properties will further dilute culling efforts.

The greatest stumbling block to genetic improvement in deer is intensity of selection. In livestock selection work and deer pen studies, there is absolute control over not just the sires (bucks) but also the dams (does). In a ranch situation, especially in a hunting situation, genetic selection is impossible on at least half of the adult population (50-75% depending on the sex ratio). Doe deer are contributing half of the genetic material for antlers and other physical traits of their fawns, and there is no way to select the “superior” and “inferior” does. This further dilutes the efforts of any culling practices.

Deer managers often conclude that progress can be made through culling, citing the importance of genetics in livestock herds. Livestock breeds have relatively little genetic

variability because the variability was intentionally eliminated in the development of the breed. The isolation of specific traits required numerous generations and intensive selection of sires and dams to eliminate the undesirable traits. The lack of variability among livestock breeds can not be compared with the relatively high degree of variability (heterozygosity) found in white-tailed deer. This is why the principle of “hybrid vigor” is successful in livestock production but does not apply to white-tailed deer management.

There are other problems associated with the logistics of harvesting at an adequate intensity. Most ranches in the western Edwards Plateau are not able to harvest enough deer to keep the deer population in check (can't find enough hunters, don't want more hunters, etc.). Most ranches would have to substantially increase their harvest intensity and harvest selectivity to produce a measurable improvement in antler quality. There are also problems associated with culling the “right” deer, especially when ranches are relying on hunters with a very wide range of experience in recognizing “inferior” deer.

Does this mean that culling and genetic improvement will not work? Absolutely not – selection for antler traits has been demonstrated in deer research pens. Genetic improvement will work best on very small, high-fenced properties. It is less practical on large, high-fenced properties. It is least practical on ranches with low fences.

Deer managers should not be disappointed by this information. With proper habitat management to boost nutrition, every ranch in Texas has the capability of producing some quality white-tailed bucks once they reach a mature age. Producing quality whitetails is more of a challenge in west Texas where weather can severely impact nutrition, and where habitat conditions (preferred plant species and grass cover) must be restored after many decades of overuse by grazing animals (livestock and deer) and the absence of periodic fire.

Summary

The most important step in a deer management program is establishing a well-defined set of objectives. Annual surveys and harvest records will assist the manager in making annual harvest recommendations, but more importantly, they are critical tools for evaluating progress toward deer management goals. The buck harvest should be used to manage the age structure of the buck segment, while the doe harvest should be implemented to meet objectives regarding deer numbers and nutrition (i.e., increase, maintain, or decrease deer numbers). Nutrition and age structure are the keys to producing quality bucks. In west Texas, nutrition is the primary factor limiting herd health and buck quality, and deer numbers can not be managed independently of livestock numbers. Genetic improvement may be a valid consideration, depending on the individual ranch and hunting operation. However, do not substitute “culling” efforts for more important practices such as proper grazing management, brush management, prescribed burning, controlling deer numbers, and establishing quality sources of food and water.

APPENDIX I

Deer Survey Techniques in the Trans-Pecos Region

Why count deer?

There are a number of reasons why a landowner might want to conduct a deer survey. The type of information needed regarding a given deer herd will be dictated by the management objectives on the ranch. Survey results can be used to determine an appropriate harvest intensity, which is essential in preventing the overharvest of a deer herd. In areas where white-tailed deer numbers are relatively high, survey results may be used to determine the appropriate doe harvest intensity to maintain deer numbers at or below carrying capacity. Some managers who operate hunting leases may be interested in evaluating the age and/or quality of bucks on the ranch prior to marketing their hunts (to determine number of hunters or lease price).

Survey Techniques

There are three deer survey methods with broad applicability in the Trans-Pecos Region. These survey techniques include: 1) fixed-wing aircraft, 2) helicopter, and 3) the mobile spotlight survey. Using a small, fixed-wing plane allows the observers to cover a lot of country in a relatively short period of time, and the method is less expensive than using a helicopter. However, fixed-wing aircraft are used infrequently relative to the other two methods because a large proportion of the deer are missed by the observers because of the speed and altitude necessary to safely conduct a survey. The problem of overlooking deer is magnified with increasing brush canopy and ruggedness of the terrain. As a result, deer surveys using fixed-wing aircraft generally result in lower deer density estimates than either of the two other survey techniques. Fixed-wing planes have their greatest applicability in relatively open and flat to rolling terrain.

The mountainous terrain of the Trans-Pecos Region, coupled with a semi-desert climate (frequent drought), present some survey challenges that do not exist in most other areas of Texas. For example, mountains can be problematic for mobile spotlight surveys in preventing vehicle access. In addition, deer concentrations that frequently exist in mountainous areas can cause sampling problems (deer distribution is influenced by environmental factors such as predators, woody cover, and changing forage conditions that are associated with elevational differences). Under drought conditions, deer herds will concentrate near watering sites, resulting in temporary shifts in deer distribution. Localized thunderstorms can produce isolated areas of forage green-up, which often results in deer concentrations and major shifts in distribution. When any of these unique challenges exist, special care must be taken to avoid biased or erroneous survey results. In certain situations, a given survey method may not be appropriate or produce reliable information. Factors to consider when determining the most appropriate survey method for your ranch include: 1) type of information needed, 2)

brush density, 3) terrain, 4) the road system on the ranch, 5) effects on deer distribution (crops, water, feeders, etc.) and 6) finances.

The two most common deer survey techniques in the Trans-Pecos and western Edwards Plateau are the spotlight survey and the helicopter survey.

SPOTLIGHT SURVEY

Methodology

The spotlight survey technique involves sampling a portion of a property to produce an estimate of the deer density on the entire ranch. More specifically, the method involves counting deer from the bed of a pickup (or elevated seat), using two spotlights (200,000 to 500,000 candlepower is adequate). Two observers shine the lights from either side of the truck while the driver maintains a speed of 8-10 mph (rough terrain will require slower speeds). Surveys should be initiated about 45 minutes after sunset and should be limited to less than 3 hours. Long routes that require more than 3 hours to complete can be conducted in sections on successive nights. Visibility estimates (distance that deer can be seen) on the right and left of the truck are taken every one-tenth of a mile for use in calculating the observed acreage. A maximum distance of 250 to 300 yards should be used, depending on light intensity and quality of optics (deer must not be confused with pronghorns, livestock, or exotics). Visibilities may be taken at night when conducting the initial count or during the day prior to the survey. If visibilities are taken during daylight hours, a laser rangefinder can help improve observer accuracy at the longer distances. Total numbers of observed deer are recorded while binoculars are used to identify bucks, does, and fawns within about 150 yards of the truck. Attempting to identify sex and age of deer beyond that distance will result in errors or biased data (spike bucks recorded as does, or fawns confused with does). The average width of the route is multiplied by the length of the route to produce the observed acreage². The observed acreage divided by the total number of deer observed provides an estimate of the deer density (acres/deer). Deer identified as bucks, does, and fawns are used to calculate the buck:doe ratio and fawn survival. Daytime observations of deer can help to increase the sample size and improve accuracy of the fawn crop and sex ratio estimates. These should be conducted whenever possible during late summer and early fall.

To obtain a reliable count using the spotlight technique, it is extremely important to establish the route through each habitat type on the property. Because it is a sampling technique, it is necessary to establish the route through various habitats or vegetation types in approximately the same proportion that they are present on the ranch. Conducting the survey through areas where most of the deer are normally seen can result in a biased (too high) population estimate. A soils map and a topographic map can be valuable tools when evaluating an appropriate location for the survey route.

² [Length of route (miles) x 1,760 yards/mile] x [Avg. visibility right (yards) + Avg. visibility left (yards)] divided by 4,840 square yards/acre = Acres Observed

Because of variability in deer movements from night to night, spotlight surveys should be conducted on 3 separate nights. One of the optimum times to conduct spotlight surveys is during late August, September and October, when bucks have hardened antlers and fawns are old enough to be following does. Important post-season information can be obtained on spotlight surveys in January. Visibilities are generally greater in winter (after leaf-drop) than in late summer; therefore, winter surveys have the advantage of increased acreage observation. However, it is generally necessary to conduct separate visibilities for late summer vs. winter surveys.

Strengths and Weaknesses

One of the greatest strengths of the spotlight survey method is its ability to provide fairly accurate estimates of deer numbers when the technique is conducted within the intended assumptions. At night, when deer are up and feeding, it is very easy to observe deer because of the reflective nature of their eyes. However, spotlight surveys tend to be less accurate in their estimates of sex ratios and fawn survival. There are several reasons for this, one of which is the generally low sample size associated with many deer counts in West Texas. Daytime observations conducted by the ranch manager can increase the sample size and help to improve the reliability of sex ratios and fawn crops. Another problem with night time observations, especially with inexperienced observers, is the tendency to “miss” small antlers such as “spikes” and classify these deer as does and to confuse fawns and does. It is critical to have good lights and to use quality optics when attempting to classify deer as to sex or age. First-time observers are encouraged to “look for spikes on every deer”. In most deer herds, there are more yearlings (1.5 years) than any other age class of bucks. And in West Texas, there is normally a relatively high proportion of “spikes” in the yearling age class. If at least a few spikes are not observed during the survey, it is likely that some young bucks are being classified as does. A general rule that will help to minimize classifying errors is to only classify deer within a certain distance of the vehicle (150-175 yards). Deer beyond that distance should be recorded as “unidentified”, because classifying deer beyond this distance will invariably result in errors. It may be fairly easy to identify a 10-point as a buck at 200 yards, but the survey will be biased if all large bucks are identified, and all other deer are recorded as “unidentified”.

One of the basic requirements of an accurate spotlight survey is a good road system on the ranch. The survey route should traverse most pastures and sample representative portions of each habitat type. When selecting an appropriate route, a general “rule of thumb” to remember is that at least 10% of the ranch should be observed during the survey. Another basic assumption is that deer are randomly distributed within a particular habitat type. Naturally, deer will be attracted to certain habitat types more than others, and this fact is unimportant because each habitat type is proportionately sampled. The point of caution concerns deer concentrations. For example, reliable spotlight counts are generally not possible when deer are concentrating on crop fields such as wheat, oats, alfalfa, etc. The best and perhaps only way to obtain a good count is to conduct the survey prior to crop emergence (not possible with perennial crops such as alfalfa). During drought, deer will tend to concentrate in the general vicinity of

watering sites. The survey will tend to overestimate deer numbers if the route is established near many of the watering sites. If the water locations are completely avoided, deer numbers will tend to be underestimated. Although the deer herd will immediately redistribute following precipitation and the emergence of annual forbs and grasses, waiting for rain in the Trans-Pecos is seldom fruitful. The next best option is to establish the route near a few water locations (proportional to the ranch acreage observed) while avoiding most, recognizing that the results may be unreliable. The location of the survey route relative to watering sites is generally irrelevant under favorable forage conditions (deer will be widely distributed).

Costs associated with spotlight surveys include 2 spotlights (\$20-30 each), binoculars, truck operating expenses, and labor (~3 hours x 3 people x 3 nights).

HELICOPTER SURVEY

Methodology

The helicopter survey technique may involve surveying the entire ranch or sampling only a portion of the property (eg., 50% or 33%). The figures from a partial count can be extrapolated to the entire ranch. The most commonly used helicopters for game surveys in the Trans-Pecos are the Robinson R22, Schweizer 300, and Enstrom F28. These relatively small helicopters have excellent visibility and maneuverability, with a survey crew consisting of the pilot and the passenger. Larger jet helicopters may be used, which have the advantage of carrying additional observers, but they are much more expensive to operate and visibility is often limited.

Aerial surveys should be conducted during early morning and late afternoon when temperatures are cooler and deer are most active. Most deer will be bedded from mid-morning through mid-afternoon, and surveying during this time will result in a relatively poor count. Cool weather can extend the survey flight time, as deer will remain active throughout much of the day. An altitude of 40-60 feet should be maintained. In relatively dense juniper or mesquite, the flight speed of the helicopter should be maintained at about 35 mph. In fairly open country that exists across much of the Trans-Pecos, the air speed can be increased to about 45 mph. A lot of deer will be missed if flight speeds exceed 50 mph.

Deer and other animals of interest (javelinas, feral hogs, turkeys, quail, predators, etc.) are counted within 100 yards of the flight path of the helicopter (a 200-yard observation strip). Ranches with extremely dense brush and trees will require a narrower observation strip (100-150 yards), while very open country may allow a wider observation strip (i.e., 300 yards). The use of a global positioning system (GPS) will improve the accuracy of transects and allow easier calculation of the observed acreage (72.7 acres/mile @ 200 yard strip-width). Deer are classified by species (whitetail vs. mule deer) and categorized as bucks, does, and fawns. Generally, bucks are further categorized into "age" or "quality" groups (i.e., spikes, small forked, medium forked, and mature).

Mountainous terrain can sometimes be surveyed more effectively along elevational transects rather than linear transects. A common practice is to survey the “bottoms” first and gradually work up the mountain because most deer will run down the mountain toward the brushy bottoms when flushed (deer may be counted twice if lower and upper elevations are surveyed in reverse).

Strengths and Weaknesses

The helicopter survey technique is a very good indicator of the deer herd sex ratio and is generally a good estimator of fawn survival, especially if conducted several months after the peak of fawning (when virtually all fawns should be following does). Another advantage of helicopter surveys is that they allow an evaluation of buck age and/or quality because a relatively large proportion of deer are observed compared to other techniques. In addition, helicopter surveys can provide population trends of other wildlife species (eg., quail, predators, elk, aoudads, etc.), some of which are difficult to survey by any other means (eg., Rio Grande turkeys, javelinas, and feral hogs).

Helicopters surveys are considerably less effective in determining accurate wildlife numbers, including deer. Numerous studies have demonstrated that only a portion of the deer in the flight path are observed (40-85%), which is largely dependent on brush density and the canopy cover of trees and brush. Other factors that will affect deer movement and observability are temperature, wind, and altitude and speed of the helicopter. Ruggedness of the terrain is another important variable affecting deer observability.

Because deer numbers are usually (if not always) underestimated using the helicopter survey technique, harvest recommendations tend to be very conservative. This is generally not a problem in west Texas if land managers are simply interested in producing mature bucks and maintaining deer numbers. However, when land managers are attempting to improve their income through deer hunting, extremely conservative recommendations can translate to dollars lost. The opportunity to harvest mature bucks is foregone, and this opportunity is replaced by considerable natural mortality of adult deer. Another problem with underestimating deer numbers exists in the western Edwards Plateau and portions of the eastern Trans-Pecos, where white-tailed deer herds commonly exceed the carrying capacity of the land (low coyote numbers and high fawn survival). Conservative doe harvest recommendations will only result in the perpetuation of the problem.

Costs associated with helicopter surveys include flight time (\$300/hour for 2-person helicopter; \$550-600/hour for 4-person jet helicopter), trailering fee (\$1.50-2.00/mile one-way), and labor (1 person x flight hours @ 2,000-3,000 acres/hour).

Summary

Spotlight surveys are relatively inexpensive to conduct and can provide good estimates

of deer numbers if conducted within the assumptions previously described. However, they require more time than a helicopter survey, and estimates of sex ratios and fawn survival tend to be unreliable. This is partially because of the relatively small number of deer observed along the route and because of differences in behavior and movement by bucks, does, and fawns. Helicopter surveys produce more reliable estimates of buck to doe ratios and fawn crops, allow population estimates of other wildlife species, and allow the land manager to evaluate the age and/or quality of his buck segment. However, annual helicopter surveys can be expensive, and they tend to underestimate the number of deer on the property by 15-60%. The survey technique that is most appropriate for a given ranch will depend directly on the type of information that is most critical to achieving the deer management objectives. Each survey technique has strengths and weaknesses in estimating certain herd parameters, but more importantly, either technique can be used to effectively manage a deer herd through annual monitoring of deer population trends.

APPENDIX J

Harvest Records: An Essential Element in Deer Management

1. **Date of Kill:** Record month and day of kill.
2. **Ranch of Kill:** Record name of ranch on which deer was killed.
3. **Hunter:** This will assist the manager in keeping track of deer records.
4. **Age:** Record age of deer in one-half year units (because they are born in summer), as determined by replacement and wear on the jaw teeth (example: 1½, 2½, or 5½). If the age of the deer can not be determined, remove one or both lower jaws so that a biologist can determine the age at a later date. If several jaw bones are retained, number each set so that once the age is determined, it can be associated with the other information collected from each respective deer.
5. **Field-dressed Weight:** Record the weight of each harvested deer. The deer should be eviscerated and the hide, head, and feet must be attached to carcass. If only a "live weight" (non-eviscerated) was obtained, the field-dressed weight can be closely approximated by multiplying the live weight by 0.75 for bucks (example: a live weight of 106 lbs. equals 80 lbs. field dressed) and 0.70 for does.
6. **Points:** Record the total number of antler points. Points are projections that extend at least 1 inch or 25mm from the surface of the antler. You may want to separately record the number of points present on the left and right sides.
7. **Antler Spread:** Record in inches or millimeters the widest distance between the main beams (inside spread).
8. **Antler Base:** Record the circumference of the antler in inches or millimeters immediately above the burr. If measuring only one antler, you should consistently use either the left or right antler (i.e., if you measure the right antler base on the first deer, then continue to use the right antler on all deer).
9. **Main Beam:** Record the length of the main beam in inches or millimeters from the antler base (bottom of burr) around the outer edge of the main beam to the farthest tip of the main beam. If measuring only one antler, use the same antler that was used in measuring the circumference.
10. **Body Condition:** Record whether each harvested deer is in good, fair, or poor condition. (example: "good"= fat across back and base of tail; fat on kidneys and in body cavity "fair"= little excess fat but no bones showing "poor"= ribs, backbone, and pelvic girdle are prominent)

11. **Lactation:** Record whether or not does are lactating (producing milk). This can provide important information about fawn survival.

Age-specific information on body weights, condition, and antler measurements can provide valuable information about the nutrition of the deer herd. This can provide immediate feedback concerning harvest and habitat management decisions. The age data alone can provide important information about the harvest intensity and resulting age structure of the deer herd. In addition to the annual use of harvest records for making deer harvest recommendations, comparing harvest information over a period of years can assist the deer manager in evaluating the trend of the deer herd. Only then can you determine whether you are approaching desired management goals.

APPENDIX K

Specific Management Recommendations for Pronghorn Antelope

Two of the most important characteristics of quality antelope habitat (more specifically, the vegetation structure) concern visibility and mobility. That is, the 2 most important mechanisms of self-defense for antelope are vision and speed. Anything that interferes with these abilities will, in the long-term, decrease their chances of survival. A third critical aspect concerning the vegetation component of antelope



habitat is fawning cover. The primary factor influencing the success or failure of an antelope herd is fawn survival (another very important factor is seasonal, long-distance movements to locate improved forage conditions). Nothing is more critical to fawn survival than adequate hiding cover (even more important than predator numbers). There are 2 factors that dictate whether fawns will have adequate hiding cover. The first factor, precipitation, is beyond the manager's control. The second factor is controlled directly by the manager and concerns cattle stocking rates and pasture deferment.

Food Habits

The majority of annual rainfall in the Trans-Pecos Region is received during late summer and fall (although annual precipitation fluctuates dramatically among years). During the good rainfall years, forb availability increases considerably during late summer and fall, and there is a corresponding increase in forb use by antelope. Forbs or broadleaf weeds are highly preferred by pronghorns, and they tend to consume them seasonally in proportion to their availability with heaviest use in the fall. Forbs are very palatable and are an excellent source of nutrients for pronghorns.

Browse species are second in importance in antelope diets and tend to be used most in spring and summer. However, woody plants can become especially important to pronghorn survival during dry seasons when forbs are not available. A few browse species, such as tarbush (*Flourensia cernua*), can be detrimental to antelope when taken in large quantities. Tarbush toxicity, combined with malnutrition, can be a problem on overgrazed ranges or during extended drought when other forage is limited.

Grasses are generally considered the least important forage category in antelope diets, as grasses only compose 6-7% of their annual diet. Although grasses represent only a

limited proportion of the annual diet, grasses can be extremely important to pronghorns on a seasonal basis. Lignin and cellulose increases in grasses as they mature (while most nutrients decline), and pronghorns have difficulty digesting mature grasses. Tender grass shoots, on the other hand, are highly palatable, nutritious, and low in lignin and cellulose. Perhaps just as important as the nutrients they contain, the timing of grass shoot emergence can be critical to pronghorn survival during some years. In most years, grasses will begin sprouting in March, prior to foliage growth on most woody plants and long before normal forb growth (stimulated by summer rainfall). The heaviest use of grasses by antelope is during March through May, with grasses representing up to 30% or more of the diet. Following a severe, dry winter, these succulent green shoots can provide a boost in nutrition that can save many antelope from starvation until woody plants grow new shoots or early rains result in forb growth. Although grasses are primarily used in spring, there is some use of sprouting cool-season grasses during late fall- early winter.

Several food habit studies were conducted in the Trans-Pecos Region to gain information about annual and seasonal pronghorn diets. The results indicated comparable annual diets, ranging from 65-70% forbs, 25-30% browse, and 5-8% grass. Heaviest use of forbs occurred during the fall, although forb use in winter was considerable (approximately 50% of diet). Browse received heaviest use in summer (60%), with considerable use in the spring (45%). Grasses were used more in the spring (20%) than any other season, with moderate use in winter (8%).

Pronghorn- Livestock Relationships

With moderate stocking rates, the degree of competition between antelope and cattle is minimal because the plants preferred by pronghorns are used very little by cattle. Cattle primarily eat grass and occasionally use forbs and browse. Pronghorns, on the other hand, prefer forbs and browse with very light use of grass species. Although grasses may represent up to 20% of the pronghorn diet in the spring, on a yearly basis grasses represent only 6 or 7% of the diet. On a range that is overgrazed by cattle, competition for forbs will increase as the quantity and quality of grasses decline.

Competition between pronghorns and sheep or goats is more significant and may result in a population decline of pronghorns due to abandonment of an area, or more often, the decline is related to malnutrition of a pronghorn herd that is confined by sheep-proof fencing. Forbs, which represent more than 60% of the annual diet of pronghorns, are also highly preferred by sheep and goats. The overlap in feeding habits can eliminate the forbs that are necessary for antelope survival. Sheep and goats can be and often are maintained on an overgrazed range through supplemental feeding, an advantage that the pronghorn must normally survive without. Under light grazing pressure, the problems just mentioned would be substantially reduced. Currently, this competition issue has considerably less relevance considering the dramatic reduction in sheep and goat numbers over the past several decades.

In average rainfall years and with timely supplementation, the local stocking rate

recommended by the Natural Resources Conservation Service provides adequate animal performance and generally does not damage forage plants. However, precipitation during most years is below average and recommended stocking rates result in a high percentage of forage utilization. When considering critical needs of pronghorns such as hiding cover for fawns, a stocking rate at about 80% of the recommended level may be more appropriate. A deferred rotation grazing system (allows antelope to select among rested pastures and allows regrowth of desirable plants, if it rains) is usually preferable to continuous grazing of all pastures. Grazing deferment also allows the manager to provide additional rest to pastures containing critical fawning grounds. Under extended drought conditions, reducing the stocking rate is the best means of allowing antelope to survive nutritionally and reproductively.

Water Availability

Pronghorn water requirements and water consumption will vary seasonally and from day-to-day depending on precipitation, temperature, humidity, and availability of green, succulent vegetation. Daily water consumption rates for adults can range from almost no intake of free water in April and May to more than a gallon per day in August. However, a close relationship exists between pronghorn distribution and the location of available water. The vast majority of antelope herds (95%) are found within 5 miles of a water source.

The majority of antelope range in Texas is well watered because of widespread watering systems for livestock. Therefore, water availability on antelope range is often taken for granted. However, situations regarding water do arise in ranching operations that can impact the pronghorn herd. For example, when livestock are removed from pastures for marketing or pasture management reasons, watering sites should be maintained so that the antelope have access to water on a daily basis.

Antelope prefer to drink from ground-level water sources such as stock tanks or windmill overflows, but they will use most water facilities designed for livestock, especially during very dry periods. The trough height (~18") and water level should be sufficient to allow weaned fawns access to water. Extremely cold weather can freeze water troughs and prevent antelope from using them. Under normal conditions, a ranching operation will break the ice in the troughs on a daily basis to keep water available for livestock. But if the livestock have been removed from a pasture, these frozen water sites may be neglected. Extended periods of extreme cold weather can severely stress a pronghorn herd, especially if they are deprived of drinking water.

Herd Movements

In the northern extremes of their range (Wyoming, Montana), pronghorns sometimes migrate up to 200 miles to avoid deep winter snows. The Texas antelope herds are not migratory; however, they do move on a limited basis in response to seasonal availability of forage. A movement of only 5 or 10 miles may be critical during dry periods when forb production has failed and woody browse plants on an adjacent range become

necessary for survival.

Ranch managers should consider the yearly movement patterns of antelope and eliminate any restrictions on these movements. Ranchers sharing the same antelope herd on an annual basis should cooperate in providing freedom of movement for the animals, which could prove beneficial to all those involved. For example, the seasonal movement of antelope from one ranch to another can improve nutrition and increase production in the herd.

The free movement of an antelope herd during all seasons is a key factor in maintaining a healthy and productive herd. Moving to a new vegetation type is the only means available to pronghorns for dealing with seasonal and weather-related changes in forage conditions. The most common barrier that restricts free movement of pronghorns is fencing. Because antelope tend to negotiate fences by diving under or going between wires, a net-wire fence or a sheep-proof, barbed-wire fence can be a serious barrier to pronghorn movements. Where such conditions exist, the ranch manager should take immediate steps to provide access through these fences. This can be done by: 1) folding up the bottom of a net-wire fence in 100-yard stretches every half mile, leaving a 16-18" gap between the fence and the ground, 2) replacing net-wire water gaps with barbed-wire, once again leaving at least 16" of space between the bottom wire and the ground, and 3) replacing 100-yard sections of sheep-proof fencing with barbed-wire fencing with the appropriate spacing between the bottom wire and the ground. These steps will improve conditions for pronghorn movements and forage selection, while still maintaining a cattle-proof fence.

An additional problem with net-wire fences is that they can increase the susceptibility of antelope to predation. Coyotes have been observed on numerous occasions chasing antelope for several miles. In a vast expanse of mixed short-grass prairie, the antelope will almost always emerge as the victor in this every day "contest." However, when a fleeing antelope is turned by a net-wire fence (or hung up or injured as they attempt to run through it), this provides the pursuing predator with a considerably greater advantage. Several accounts have been documented of coyotes using net-wire fence corners to hem up a fleeing antelope.

Predation

Predation is only one of many factors that influence pronghorn populations. Several studies across the United States have shown that predator management is not always the answer for increasing pronghorn numbers. However, predation has proven to be more significant on marginal pronghorn ranges and in areas where predator numbers are high in relation to antelope numbers. Both of these situations exist for many of the pronghorn herds in the Trans-Pecos because of frequent droughts and high coyote populations across most of the region. Therefore, predation may be a much more important limiting factor among many Trans-Pecos herds than for pronghorn herds in other states.

In Texas the primary predator on antelope is the coyote, with considerably less predation by golden eagles, mountain lions, and bobcats. Most of the fawns are killed during their first month of life, although both coyotes and eagles have been observed attacking adults. Small, isolated herds are more vulnerable to the effects of predation due to the small number of fawns that are born. Several studies in Texas have shown that intensive (aerial) and timely coyote control (March-May) can allow greater fawn survival and at least temporarily increase pronghorn numbers. Whether the herd can be sustained at this higher level will be dictated by the quality of the habitat and the presence of other limiting factors such as an extended drought. In some situations, predation may serve as a means of herd stabilization, keeping pronghorn numbers below carrying capacity and preventing severe die-offs during droughts.

When considering predator management as a means of increasing pronghorn numbers, remember the following facts:

- 1) Predators do kill pronghorns, especially fawns, but predation is only one of many factors that influence pronghorn populations.
- 2) Timely and intensive coyote control has resulted in significantly greater fawn survival in some situations.
- 3) Predator control is not the answer for every situation where pronghorn numbers are low.
- 4) Pronghorns evolved with and survived with predators for thousands of years.
- 5) Habitat quantity and quality is the overriding influence on all factors harmful to pronghorns, including predation.

Herd Management

Successful herd management of pronghorns requires knowledge of key factors, such as 1) the number of animals present, 2) sex and age composition of the herd, 3) sources of mortality, and 4) changes in forage conditions. The harvest of surplus antelope through controlled hunting is the primary tool used in the management of pronghorn herds. The harvest of mature bucks can produce trophies for hunters, be a source of income for landowners, and help in maintaining a healthy herd. Only on rare occasions are permits issued for doe antelope, and these usually involve situations where animal numbers need to be reduced to avoid long-term damage to forage resources.

Landowners interested in managing their pronghorn herd should have some specific objectives and develop a management plan. If quality or trophy-class bucks are desired, then a relatively large number of bucks will need to be maintained in the herd to allow the animals to reach a mature age. This generally requires a minimum buck to doe ratio of 1:3 but may exceed a ratio of 1:2. For pronghorn herds recovering from drought and for those with exceptionally low fawn survival, a post-harvest ratio of 1:4 may be more appropriate. In order for the bucks to develop horns in excess of 14" in length, the majority of the bucks should reach at least the 4-year age class. For hunters that are satisfied with smaller horns, then a greater number of bucks can be harvested, as long as it is within the permit issuance rate.

Although your pronghorn harvest management may be somewhat limited by permit issuance, there are a number of other management practices that can be implemented on your property to ensure the continued health and productivity of the pronghorn herd. These include grazing management, improving water availability, eliminating barriers to herd movements, and predator management.

APPENDIX L

Specific Management Recommendations for Desert Bighorn Sheep

BIOLOGY AND SOCIAL BEHAVIOR

Desert bighorn sheep are social animals that associate in small groups most of the year. Larger groups are observed during August and September, which is the peak of the breeding season. Rams form bachelor groups after the breeding season and tend to use less rugged terrain and habitats not used by ewes and sub-adults, reducing competition for available resources (Bleich 1993).



Desert bighorn ewes typically breed when they are 2.5 years of age and give birth to one lamb after a gestation period of six months. The majority of lambs are born in February and March, although lambing may occur through July. The extended lambing season may be advantageous in the unpredictable desert environment in which adverse conditions could eliminate an entire lamb crop if they were produced in only one month. Adult ewes produce a single lamb and twinning is extremely rare which makes their reproductive potential low; however, bighorn sheep are long-lived, which may compensate for their low reproductive rate. Bighorn sheep surviving their first year often reach 10-12 years of age (Turner and Hansen 1980).

Bighorn sheep transfer home range knowledge from one generation to the next and rarely re-colonize ranges where they have been extirpated. Rams may naturally move long distances between mountain ranges in search of ewes during breeding season, and normally return to their natal home if they do not locate other bighorns. Ewes rarely follow rams on these journeys (Geist 1971). Therefore, transplants are necessary to establish populations in new areas. Some transplanted bighorn sheep are highly exploratory and may establish metapopulations through intermountain movements. Metapopulations are defined as populations of bighorns which may be widely separated and inhabit separate mountain ranges; however, interchange occurs because of exploratory movements of individuals and are considered as part of a larger population.

The Sierra Diablo/Baylor/Beach Mountains are a system of interchanging bighorn populations or metapopulation as described by Hanski and Gilpin (1991). These movements may re-establish patterns that were previously lost when populations were

extirpated. The designation of the Sierra Diablo/Baylor/Beach Mountains metapopulation of bighorn sheep is a logical approach for managing the long-term viability of this population. This approach recognizes the importance of intermountain areas providing for interchange of individuals between populations and the potential for colonizing vacant habitats. Management of movement corridors between populations is critical to ensure the long-term persistence of desert bighorn sheep and will entail greater coordination between agencies and landowners for management of single populations (Bleich et al. 1990, Bailey 1992).

One hundred bighorn within a population or metapopulation is considered the minimum number for long-term survival based on Berger's (1990) analysis that populations of this size persisted up to seventy years. Smaller populations are more vulnerable to extinction than are large populations. However, recent information indicates that many populations numbering less than fifty have survived for more than fifty years. Wehausen (1995) suggests that populations of this size may be worth establishing, especially if they are part of a larger metapopulation.

HABITAT REQUIREMENTS



The most important habitat requirement of desert bighorn sheep is open, mountainous or canyon habitats close to escape terrain (cliffs of 60% slope or greater). Bighorn rely on keen eyesight and open terrain to detect predators and elude them by fleeing to escape terrain. Escape terrain is particularly important for ewes when lambing and rearing young. Rams will use denser vegetation and stray further from escape terrain than will maternal groups. The amount of habitat available to bighorn sheep is ultimately determined by the amount of escape terrain close to open landscapes (McCarty and Bailey 1994).

Shrubs dominate the diet of desert bighorn in the Chihuahuan Desert of Texas. However, bighorn consume a wide range of plants and vary their selection based on the most nutritious plants available seasonally. Bighorn favor newly emergent grasses and forbs during the summer-fall rainy season whereas use of shrubs is greatest in winter and early spring as grass quality declines. The quality and diversity of available plants are considered important to desert bighorn sheep (Sandoval 1979, Bavin 1982, and Elenowitz 1983).

Water is used year-round by desert bighorn sheep. Although some indigenous populations may have depended solely upon ephemeral water sources and succulent plants, water is readily used when provided and is an important factor in the selection of home ranges (McCarty and Bailey 1994).

IMPACTS

Domestic sheep and goats

Abundant evidence implicates domestic sheep as one cause of bighorn declines and localized population extinctions from historical times to present. These domestics and their feral relatives use the same habitats as desert bighorn, compete for forage, and carry diseases that are lethal to desert sheep (Foreyth and Jessup 1982, Jessup 1985, McCarty and Bailey 1994). Domestic goats are also considered a potential health threat to bighorn sheep. Although domestic sheep and goats do not occur in currently occupied bighorn range, the occurrence of feral animals are a constant concern.

Cattle

Bighorn sheep generally do not compete for forage with domestic cattle under normal grazing systems because bighorn tend to occupy rugged habitats that cattle avoid. Periodically, grazing areas may overlap. Bighorn may range into flats during the spring to obtain the earliest green forbs and cattle may range into rugged terrain not normally used if they cannot find enough forage in less rugged terrain. In contrast to domestic sheep, cattle have not been implicated in causing the die-off of bighorns, nor has disease transmission from cattle to bighorn been conclusively shown. Cattle do carry diseases that are believed to be transmissible to bighorn (Jessup 1985, McCarty and Bailey 1994).

Exotic Ungulates

Aoudad sheep (*Ammotragus lervia*) are occasionally sighted in desert bighorn habitats. The aoudad has a higher reproductive potential than bighorn sheep, the ability to subsist on lower quality forage, and a preference for habitat similar to that of bighorn (Seegmiller and Simpson 1979). Aoudads are socially aggressive when they encounter bighorn and have been observed to herd female bighorn. Aoudad are capable of moving extensive distances and may be potential reservoirs of parasites and diseases detrimental to desert bighorn and other ungulates. Their potential to transmit diseases to bighorn is unclear (McCarty and Bailey 1994). Forty-five aoudads were collected for sampling in Brewster County, Texas from 1985-1986. Serum samples tested positive for eleven diseases including epizootic hemorrhagic disease (EHD), bluetongue (BT), bovine viral diarrhea (BVD), visticular stomatitis virus, infectious bovine rhinotracheitis, bovine herpesvirus-1, brucellosis, leptospirosis, Q-fever, rocky mountain spotted fever, and lyme disease (Johnson 1986).

Deer

In most western states desert bighorn sheep generally do not compete for forage with mule deer because deer use less rugged terrain and more heavily vegetated areas than do desert bighorn. In Texas the habitats of desert sheep and mule deer often overlap, creating some potential for forage competition during extended dry periods. Mule deer will share watering holes and mineral licks with bighorn sheep, and could be a potential source of disease. Water facilities developed for bighorn sheep in areas previously devoid of water may encourage deer use of bighorn habitat (Smith and Krausman 1988).

Predators

The mountain lion is the principal predator of bighorn sheep in Texas. Bighorn are also potential prey for coyotes, bobcats, black bears, and golden eagles. Predation is not considered a limiting factor in large, free-ranging populations. However, predation can be a significant mortality factor in fenced, recently introduced, or small populations (Wehausen 1992). Additionally, populations that habitually use habitat far from escape terrain or in dense vegetative cover are more vulnerable to predation (McQuivey 1978). Currently, the Texas Parks and Wildlife Department (TPWD) selectively removes predators from state-owned bighorn sheep ranges.

Fire Suppression

The suppression of fire over the last 100 years has allowed shrubs and stands of pinyon-juniper to encroach onto once open habitat, decreasing suitability for bighorns. Prescribed burns can be used to open more areas and increase the amount of suitable bighorn range (Wright and Bailey 1982).

Recreation

Desert bighorn by their nature are relatively intolerant of humans and the associated disturbances. Their flight distance increases in proportion to how secure they feel. Bighorn generally do not react to moving or parked vehicles and are not stressed by aircraft unless actively pursued. When bighorn are in escape terrain, they will tolerate people as close as 200 yards. If the bighorns are in less rugged terrain, they may flee when people are as far as a half mile away. Recreational use of bighorn habitat can be harmful, especially if the disturbance persists or occurs frequently. When bighorn are continually disturbed they may abandon habitat and water sources, resulting in decreased numbers and distribution (reviewed by McCarty and Bailey 1994). Lastly, increased recreational activity increases the potential for intentional human harassment and illegal kill. No use of llamas and goats as pack animals should be allowed in areas occupied by desert bighorn sheep, as there is potential for disease transmission.

Mining

Bighorn may temporarily abandon habitat while it is being mined, which could be critical if mining occurs on lambing grounds or near water sources. Roads for mining activities may provide access into previously undisturbed areas and increase potential negative impacts of people in bighorn habitat (McQuivey 1978).

Illegal Harvest

The relative impact of poaching on a population depends on the sex and numbers of animals taken. Illegal harvest of rams decreases the ram:ewe ratio and the availability of rams for future legal harvest. Additionally, black market trophy hunting may increase as populations increase in size and distribution.

Man-made Barriers

Barbed and net wire fences restrict movements and are a hazard to desert bighorn sheep because they are poorly adapted for jumping and may die if they become entangled (Elenowitz 1983). Bighorns will readily cross two-lane roads that dissect their habitat, but four-lane highways may inhibit movement and cause higher mortality from accidents with vehicles. Housing developments also disrupt travel corridors, fragmenting use of desert mountain complexes by metapopulations. Isolation from human services currently limits housing development in most desert bighorn habitats. As the state's human population increases and traditional uses such as ranching potentially decline, urbanization will encroach further into desert bighorn habitat.

Disease

Desert bighorn are more susceptible to diseases and parasites than other native big game species. Bighorn are particularly susceptible to diseases carried by domestic sheep and typically develop bacterial pneumonia following contact (Jessup 1985, McCarty and Bailey 1994). This is the basis of strict guidelines for separating wild and domestic sheep adopted by the Bureau of Land Management (Desert Bighorn Council Technical Staff 1990).

In contrast to domestic sheep, cattle have not been implicated in the die-off of bighorn sheep nor has disease transmission from cattle to bighorn been conclusively proven. Cattle do carry diseases that are transmissible to bighorns (Jessup 1985, McCarty and Bailey 1994). Logically it follows that bighorns could be a potential source of infectious agents to cattle; there is no documentation of disease transmission to cattle. As a precaution, desert bighorn sheep are screened and tested for diseases before release from out of state to avoid introducing infectious agents into new areas.

Literature Cited and References

- Bailey, J. A. 1992. Managing bighorn habitat from a landscape perspective. Bienn. Symp. North. Wild Sheep and Goat Council. 8:49-57.
- Bavin, B. 1982. Post-release study of desert bighorn sheep in the Big Hatchet Mountains, New Mexico. Desert Bighorn Council. Trans. 24:12-14.
- Berger, J. 1990. Persistence of different-sized populations: An empirical assessment of rapid extinctions in bighorn sheep. Conserv. Biol. 4:91-98.
- Bleich, V. C. 1993. Sexual segregation in desert-dwelling mountain sheep. Ph.D. Thesis, University of Alaska, Fairbanks. 126pp.
- _____, J. D. Wehausen, and S. A. Holl. 1990. Desert-dwelling mountain sheep: conservation implications of naturally fragmented distribution. Conserv. Biol. 4:383-390.
- Carson, B. 1941. Man the greatest enemy of desert bighorn mountain sheep. Texas Game, Fish and Oyster Commission. Bull. 21, Austin. 23pp.
- Desert Bighorn Council Technical Staff. 1990. Guidelines for management of domestic sheep in the vicinity of desert bighorn habitat. Desert Bighorn Council. Trans. 34:33-35.
- Elenowitz, A. S. 1983. Habitat use and population dynamics of transplanted desert bighorn sheep in the Peloncillo Mountains, New Mexico. M.S. Thesis. New Mexico State Univ., Las Cruces. 185pp.
- Foreyth, W. J., and D. A. Jessup. 1982. Fatal pneumonia of bighorn sheep following association with

- domestic sheep. *J. Wildl. Dis.* 18:163-168.
- Geist, V. 1971. Mountain sheep, a study in behavior and evolution. Univ. Chicago Press, Chicago. 383pp.
- Hanski, I., and M. Gilpin. 1991. Metapopulation dynamics: brief history and conceptual domain. *Biol. J. of the Linnean Soc.* 42:3-16.
- Jessup, D. A. 1985. Disease of domestic livestock which threaten bighorn sheep populations. *Desert Bighorn Council. Trans.* 29:29-33.
- Johnson, L. L. 1986. Parasites and selected diseases of barbary sheep (*Ammotragus lervia*) in the Glass Mountains of Brewster County, Texas. M.S. Thesis. Sul Ross State Univ., Alpine. 76pp.
- McCarty, G. W., and J. A. Bailey. 1994. Habitat requirements of desert bighorn sheep. *Colo. Div. of Wildl. Spec. Rep. No. 69*, Denver, 27pp.
- McQuivey, R. P. 1978. The desert bighorn of Nevada. *Nevada Dep. of Fish and Game Biol. Bull.* 6, Reno. 81pp.
- Sandoval, A. V. 1979. Preferred habitat of desert bighorn sheep in the San Andres Mountains, New Mexico. M.S. Thesis. Colorado State Univ., Fort Collins. 314pp.
- Seegmiller, R. F., and C. D. Simpson. 1979. The barbary sheep: some conceptual implications of competition with desert bighorn. *Desert Bighorn Council. Trans.* 23:47-49.
- Smith, N. S., and P. R. Krausman. 1988. Desert bighorn sheep: a guide to selected management practices. *U.S. Fish and Wildl. Serv., Biol. Rep.* 88(35). 27pp.
- Turner, J. G., and C. G. Hansen. 1980. Reproduction. Pages 145-151 in G. Monson and L. Sumner, eds. *The desert bighorn: its life history, ecology, and management.* Univ. Ariz. Press, Tucson.
- Wehausen, J. D. 1992. Demographic studies of mountain sheep in the Mojave Desert: report IV. Final Rep. Submitted to the Calif. Dep. of Fish and Game, Agreement No. FG9239. 54pp.
- _____. 1995. Rapid extinction of mountain sheep populations revisited. Unpubl. Paper presented to Desert Bighorn Council. Meeting 1995.
- Wright, H. A., and A. W. Bailey. 1982. *Fire Ecology.* John Wiley & Sons, New York.

APPENDIX M

Specific Management Recommendations for Javelinas

The javelina, or collared peccary, evolved in South America and migrated north, arriving in Texas, New Mexico, and Arizona relatively recently (past several hundred years). Javelina bones are not found in archaeological sites in the United States, and early settlers made infrequent references to their occurrence. It is probable that the javelina expanded into south and west Texas simultaneously with the encroachment of brush and cacti into Texas' native grasslands.



Biology

Adult javelinas generally weigh 35 to 60 lbs., with the male being slightly heavier than the female. Behavior toward predators and humans suggest that javelinas can see fairly well up to about 75 yards. They rely heavily on their sense of smell, not only for foraging but also for avoidance of danger. Their primary activity periods are early morning and late evening. When temperatures are cool, the herds become more active throughout the day. Although somewhat active at night, their night-vision is believed to be only fair. Javelinas are extremely territorial, and the boundaries of the territory are marked by scent emitted from the conspicuous musk gland located on the animal's rump. Home ranges of adjacent javelina herds may overlap slightly, but the "common ground" is normally used by only one herd at a time. The average gestation period is about 145 days, considerably longer than the common pig (112 to 116 days). Litters range from one to five piglets, with an average litter size of two. The young are born throughout the year, with a peak occurring in early summer. Newborn javelinas weigh about one pound, and they continue to grow until they reach adult height in about 10 months. At this age, javelinas are reproductively mature. They are capable of breeding throughout the year, the only wild ungulate in the western hemisphere with a year-long breeding season. This long breeding season, early sexual maturity, and the ability to have two litters each year gives them the greatest reproductive potential of any North American big game animal.

Home Range

Herd territories may extend over 700 to 800 acres. A South Texas study found that size of territories was associated with brush density. Territories averaged 250 acres in dense brush, 400 acres in moderately dense brush, and 700 acres in relatively open brush. A study in New Mexico reported herd home ranges that ranged from 140 to 700

acres. In Arizona, size of territories was extremely variable, ranging from 250 to 1,150 acres. The reported mean home range for collared peccaries in Big Bend National Park was 533 acres. Recent research in the Davis Mountains indicated home ranges that varied between 400 and 600 acres.

Mortality

Winter snows, ice storms, and extremely cold weather can result in substantial mortality among javelinas. However, because their distribution is restricted to southern climes, they are seldom exposed to extended, severe winter weather. Of much greater significance to herd survival is habitat loss and habitat degradation (eg., herbicidal prickly pear control, mechanical brush clearing, etc.). Sport hunting is another source of mortality, but javelina hunting in west Texas seldom occurs at an intensity that will impact herd numbers. The primary predator of javelinas in west Texas is the mountain lion. Although limited in numbers and distribution, black bears are efficient predators of javelinas when the opportunity occurs. Coyotes and bobcats will occasionally prey on javelinas, although the usual targets are the young. However, adult javelinas are extremely protective, and preying on their young is a dangerous and probably infrequent undertaking for mid-size predators like coyotes and bobcats. Although not a frequent occurrence, golden eagles will sometimes prey on young javelinas.

Diet

Javelinas will consume a wide variety of forage types, including cacti, fruits, tubers, bulbs, beans, nuts, and forbs. A diet study in the Trans-Pecos indicated that lechuguilla was extremely important to javelinas in this region, representing as much as 50% of the diet in some seasons. Acorns were also very important on a seasonal basis (fall and early winter), providing a key source of energy. Other important foods were mesquite pods, sotol, woody plants (browse), and grasses. A minimal amount of animal matter was found in the diets, although worms and insects were taken on occasion. Probably the most important food item to the javelina in Texas and throughout its range is prickly pear (represents 30-80% of the annual diet). However, its importance does not stem from palatability or nutritional quality. In fact, prickly pear is somewhat deficient in protein, carbohydrates, and most minerals. It appears that the cacti's importance is associated with its water content, its availability, and the javelina's ability to survive on the plant until forage conditions improve. Prickly pear cladophylls (pads) consist of up to 90% water, and can easily provide the daily water needs of javelinas. Cactus plants are fairly abundant in most areas of the Trans-Pecos, and adequate quantities can be taken with a minimum of energy expenditure. Javelinas prefer quality forages such as forbs, bulbs, tender grass shoots, and fruits/mast from woody plants, and they can easily meet their nutritional requirements on a diet of these quality forages. However, in the arid conditions of the Trans-Pecos, quality forages are rarely abundant and are usually available (i.e., green) only for a brief period. This is why prickly pear is a critical component of javelina habitat in the desert southwest. Prickly pear and other cacti could be referred to as "emergency" foods, but this seems a misnomer in the Chihuahuan Desert where these forage emergencies are the prevailing situation rather

than the exception. Prickly pear becomes less important as a habitat component in areas with higher annual rainfall (eg., Edwards Plateau), where quality forages are more abundant and available for longer periods of time.

Water Requirements

Javelina water requirements are influenced by temperature, humidity, diet, and physiological state. They will use water if available, but its presence is not essential if succulent vegetation (i.e., green forbs, grass shoots, prickly pear, other cacti) is available. An adult javelina can meet its daily water requirements by consuming 3.5 lbs./day of green cactus in the summer and about 3 lbs./day of green cactus in the winter. Javelinas minimize water requirements in summer (i.e., water loss from thermoregulation) by seeking shade in dense woody cover.

Herd Management

As with any wildlife species, habitat quality is the overriding influence on the presence and productivity of javelina herds. For reasons described above, prickly pear, lechuguilla, sotol, and several species of cacti are important components of javelina habitat. Not only are they important as key forages, but they are the predominant source of water for javelinas, especially on ranges where other forms of water are absent. When controlling prickly pear with a herbicide such as picloram, leaving several clumps of untreated plants within key areas is important in maintaining healthy herds of javelinas. When moisture conditions are more favorable, forbs, grasses, and browse are important in boosting the nutritional plane of javelinas. Therefore, livestock grazing can have a significant impact on the condition and productivity of javelina herds. Sheep and goats may compete with javelinas for limited forages, and at heavy stocking rates or during drought, even cattle can compete for available forage.

Another critical habitat component is dense thickets of woody cover. Dense woody vegetation is important in providing shade and loafing areas in summer and protective cover from inclement winter weather. When implementing broad scale brush management programs, managers can inadvertently destroy prime javelina habitat by failing to identify and protect a few key areas of dense, protective cover for javelinas. A certain amount of brush is desirable for screening cover as javelinas move about and forage, but even more important for survival are the dense thickets used for escape cover, shade, and protection from winter storms.

The size of herd territories will depend on brush density and overall habitat quality. But given that most herds will range over about a mile, one watering site per 2,000-2,500 acres will allow each herd access to free-standing water (if water is a concern). Particularly in areas where water sources are absent and prickly pear and other cacti are in short supply, watering facilities will probably provide realistic benefits to javelina herds in the area.

Concerning the impact of predators on javelina numbers, once again the greatest factor

of influence is the quality of the habitat. If there is adequate screening cover, escape cover, and year-round nutrition to support good reproduction, the herd can sustain a reasonable amount of pressure from mountain lions, bobcats, and coyotes. The only time predators may present a problem is in the rare circumstance when predator numbers (especially lions) are abnormally high and habitat components are marginal for javelinas. A similar relationship exists for sport hunting as a potential threat to javelinas. The greater the habitat quality, the lesser the likelihood that hunting will impact javelina numbers. On ranches where javelinas are intensively hunted, it is recommended that herd numbers and average herd size be monitored annually to ensure that the population is not declining. Reproductive success will vary from year to year, depending on drought and resulting forage conditions; but a conservative harvest rate of 15% of the fall population will generally not impact herd numbers.

APPENDIX N

Specific Management Recommendations for Black Bears



Historically, the black bear (*Ursus americanus*) was found in most ecological regions in the state of Texas. During the 1920's and 1930's, bears were fairly common in the pine-oak woodlands of western Texas. Unregulated hunting, loss of habitat, and extensive predator control programs sanctioned by the government were all factors that contributed to the black bear's decline in Texas. By the 1940's, bear sightings were few with most reports coming from the rugged canyons and mountains of the lower Big Bend Region. This area was the last stronghold of the black bear in Texas, but by the 1950's the black bear was essentially extirpated. An occasional bear sighting was still reported from the lower Big Bend area, which tended to be associated with wildfires in the adjacent Mexican mountains. According to Baker (1956), bear numbers had drastically declined in Mexico with only remnant populations in the mountains of northern Coahuila. In 1986 Mexico placed the black bear on their endangered species list and closed the hunting season indefinitely. Texas followed suit in 1987, placing the bear on the state endangered list. At this point, it appeared that the black bear was gone from Texas with no plans for reintroduction.

Recovery

Natural recovery by a wildlife species into former historical range rarely occurs without the intervention of man. Yet, an amazing reestablishment of black bears into portions of their former range in Texas is occurring. During the 1980's bear sightings became more frequent, especially in Big Bend National Park (BBNP) and on the adjacent Black Gap Wildlife Management Area (BGWMA). In 1988 a tourist in BBNP photographed a sow with three cubs, and in 1994 a hunter on the BGWMA also photographed a sow with three cubs. Observations of bears and their sign are increasing, and people on private lands as well as the federal and state lands in western Texas now find themselves living in "bear country." To the south in the state of Coahuila, Mexico the bear population has recovered and is increasing. It is likely that the black bear will continue to disperse into western Texas from viable populations in northern Mexico.

Biology

Black bears are typically thought of as forest creatures. However, they will use other habitats where food is available. In the Chihuahuan Desert of western Texas, black

bears are found in the pine-oak woodlands of the mountains and in the lower desert elevations.

Black bears are stocky with powerful legs and short tails, and they walk slightly pigeon-toed. Despite the name "black bear," their pelage may be various shades of brown. Some bears have tan muzzles, and may or may not have a white blaze on their chest. Adult males can weigh almost 400 pounds. Females (sows) are smaller, weighing from 100 to 200 pounds. Typically, adult bears measure about 36 inches at the shoulder and are 4 to 6 feet tall when standing upright.

Black bears are solitary creatures except during the breeding season in summer, or when a sow is with her cubs. Sows normally breed when they are 3 to 4 years old. They usually breed every other year and will have 1 to 4 cubs, with 2 or 3 cubs being most common. The cubs are born in late winter/early spring and remain with the sow through 2 spring seasons.

In west Texas bears do not enter a true state of hibernation during the winter. Instead, they enter brief periods of denning. They may choose a den site in a rock pile, brush pile, cliff overhang, or cave. During the denning period, bears may waken and move about short distances to water and feed. When the cubs are born, the sow will remain with them in the den, emerging only after the cubs are large enough to travel with her.

Home ranges vary, depending on habitat, availability of food, and geographical location. Home ranges of males are typically much larger than females. Bears may travel great distances in search of food, mates, and suitable habitat.

Food Habits

Black bears spend a large portion of their time seeking food. In the pine-oak habitat at higher elevations, important bear foods include madrone, juniper and algerita berries; acorns; Mexican squawroot; pinyon nuts; and a variety of grasses, insects, and carrion. In the lower desert elevations important bear foods are acorns, prickly pear fruits, Texas persimmons, Spanish dagger, sotol and yucca hearts, mesquite beans, and grasses.

During the winter and early spring, bears are somewhat lethargic and their appetite diminishes. In the lower elevations of west Texas, acorns, remnant persimmons, insects, and the hearts of Spanish dagger, sotol, and yucca comprise a major portion of the winter/early spring diet. In pine-oak habitat at higher elevations, predominant food items are acorns, pinyon nuts, juniper berries, madrone berries, and insects.

During summer bear diets will reflect the availability of fruiting plants in their home range. Bears feed heavily on mesquite beans, which contain 11-13% crude protein and are extremely high in energy. The fruits of prickly pear, Texas persimmon (late summer), and algerita are also important components of the summer diet. The summer diet is supplemented with the hearts of Spanish dagger, sotol and yucca.

The greatest foraging season for bears is fall when they need to build up a fat supply to last them through the winter. Weight gain is considerable prior to the winter months. Acorns are the single most important food item in the diet during the fall. Although acorns are relatively low in crude protein (4-6%), they are one of the best energy foods available. Acorns are followed in importance by madrone berries at the higher elevations and remnant persimmons in the lower elevations. During low acorn-production years in the higher elevations, madrone and juniper berries tend to be the major food items in the fall diet.

Research on bear diets in the pine-oak habitats of west Texas and northern Mexico (Doan-Crider 1995) has shown a relatively low percentage of animal matter in the diet (7-8%). Mammals represented a very small portion of the diet (1-2%). The remains of 5 mammals were identified as deer, javelina, coyote, skunk, and a rodent. It is unknown whether these animals were taken through predation or fed upon as carrion. Several scats contained bear hair but were suspected to have occurred as the result of grooming activity. In the lower desert elevation, over 400 black bear scats (dried feces) were analyzed. One scat contained mule deer hair, and one scat contained black-tailed jackrabbit hair (McKinney and Pittman 1999).

Foods that may attract bears are dog food, cat food, livestock feed, hummingbird feeders, garbage, and lard. Occasionally, a bear will kill and feed on livestock. Predation by bears tends to occur more often during drought when vegetation and other natural foods are limited. Predation on calves and young horses is extremely rare, while black bear predation on goats or sheep is more common. Because bears will feed on carrion, they are often blamed for livestock deaths that they did not cause.

Incidents of bears preying on their own species have been documented numerous times, with cubs being the primary target of this intraspecies predation. This phenomenon tends to be more of a problem in areas where bear numbers are relatively high. In such situations, cubs as well as adult females are sometimes killed by rogue males and may or may not be fed upon.

Water

Water use and its importance to bears in west Texas has not been documented. Based upon observations and preliminary research, it is likely that water is critical for establishing black bear populations. When forage conditions are good and succulent herbaceous vegetation and fruits are abundant, bears can probably survive for some time without standing water. Ripe fruits and green grasses and forbs contain from 70-90% water, and during certain seasons bears can probably obtain adequate water from these forages. However, most of the time the Trans-Pecos is hot and dry, and forages are less than succulent. Bears will seek standing water not only to replenish daily water loss but also to cool off, especially in the summer months.

Habitat Management Recommendations

Bears prefer shady, cool places (canyons and mountain slopes with trees), but will live anywhere there is adequate food and water. Canyons tend to be good bear habitat not only because of their cooler temperatures but because they tend to support a variety of plants for both food and cover. Whether for protection of cubs or because of the availability of food, sows with small cubs will often “hole up” in isolated canyons. These timbered canyons are key habitats that may require protection during certain management activities such as aerial herbicide, mechanical brush removal, etc. These areas may also require periodic rest from livestock grazing. Promoting the growth of native, mast-producing shrubs and trees in these canyons and other key habitat sites may help to improve the quality of bear habitat on your property.

Riparian areas support an abundance of herbaceous vegetation and woody cover, and usually support some of the best mast-producing trees and shrubs. These are key habitat sites that are used by bears (and most other wildlife species) for foraging and as travel corridors. Protection of riparian areas will help to maintain the quality of food and cover for a variety of wildlife species currently residing on your property, as well as for a gradually recovering bear population. Fencing along riparian areas can be extremely valuable in controlling the intensity and duration of livestock grazing.

The distribution and survival of bears is highly dependent on food availability, and any management practice that maintains or improves the diversity and availability of food will increase the potential for bears to successfully reside on the property. Grazing management strategies that incorporate periodic rest for pastures while maintaining light to moderate stocking rates can improve the quantity and quality of foods for bears and other wildlife. Infrequent prescribed burning can stimulate the germination and/or growth of a variety of plants, including key mast producers. Bear habitat can be improved by removing invasive woody species such as creosote, tarbush, and dense mesquite while maintaining mature mesquites, oaks, Texas persimmons, juniper, Spanish dagger, sotol, and yucca species. Water conservation and erosion control practices can also make subtle, long-term improvements (or prevent degradation) in the availability of food and cover.

Availability of water can be an important component of bear habitat. Water in catchments, guzzlers, troughs and tanks should be maintained to ensure availability of water for bears and other wildlife. Bears love to play in water; therefore, large or deep catchments and storage tanks should have a means of escape. This can be done by placing a ladder or escape log in storage tanks. One end of the escape log (at least 4-5” in diameter) should be wired to the edge of the tank while the other end is allowed to float with the water level. If water storage tanks with lids are used, the lids should be secured with a latch to ensure that bears can not pry the lids open and climb into the tank. Bears will damage float valves in livestock troughs and bite holes in above-ground plastic pipe. Burying plastic pipe and welding a metal cage over float valves can prevent these problems. When rotating livestock herds or temporarily destocking, water

facilities in vacant pastures should be in operation and maintained for the benefit of bears and other wildlife. Establishing permanent water sources in remote locations can reduce the potential for bear/livestock conflicts.

Coexisting With The Black Bear

Many states in the United States have black bear populations, and people coexist with them on a daily basis. In the southwestern United States and northern Mexico, black bears are found on many ranches and farms, as well as in parks and on state and federal lands. In western Texas black bears are gradually increasing in number, and few bear/livestock or bear/human conflicts have occurred. Several successful black bear relocations have been conducted recently by TPWD.

Bears are very intelligent and curious. Sometimes their natural curiosity and opportunistic feeding habits cause them to lose their natural fear of human activities. The result is a nuisance bear that is a potential threat to humans. Occasionally, bears can be relocated successfully many miles from the area where they were creating problems. But often, these nuisance bears must be destroyed. Supplemental feeding of bears is not recommended. Bears that are fed can lose their desire to forage on natural foods and can quickly become nuisance bears. A bear may not be considered a nuisance by the individual who was feeding it, but it will inevitably become a nuisance (and possibly a danger) to someone. Ultimately, a nuisance bear will have to be relocated, if not destroyed.

If you have black bears on your property, there are some specific actions and management techniques that can be used to prevent bear damage and conflicts, and allow the black bear to continue its natural recovery in western Texas.

1. Do not feed bears. They learn quickly and will begin to expect free handouts. This can quickly create a problem bear. This type of bear can become a threat to humans and may have to be destroyed.
2. Keep a safe distance; do not approach or harass a bear. Black bears are wild animals and are fast, powerful, and unpredictable.
3. Maintain clean, garbage-free grounds. Keep garbage in containers with locking lids and dispose of garbage by burning or burying it.
4. Keep pet and livestock foods in buildings with closed and latched doors.
5. Burn livestock carcasses, and during the hunting season burn game hides and viscera to prevent bears from feeding on them.

The black bear is currently listed as a “state threatened species.” TPWD is responsible for the protection and conservation of black bears in the state. TPWD is currently monitoring the distribution and status of bears throughout the state and is actively conducting research on reestablishing populations. TPWD is also committed to assisting landowners with bear problems and will help to resolve any bear-related conflicts that may occur. If you have a nuisance bear on your property, do not attempt to trap or shoot the bear. If you see a bear on your property or experience a problem

with a bear, please notify:

Texas Parks and Wildlife Department
1-800-792-1112

TPWD, San Angelo Regional Office
(915) 651-4748

Black Gap Wildlife Management Area
(915) 376-2216 or 376-2273

TPWD Alpine District Office
915) 837-2051

Elephant Mountain Wildlife Management Area
(915) 364-2228

Or call your local TPWD game warden or wildlife biologist.

Literature Cited

Baker, R. H. 1956. Mammals of Coahuila, Mexico. Univ. Kansas Publ., Mus. Nat. Hist., 9(7): 125-335.

Doan-Crider, D. L. 1995. Food habits of the Mexican black bear in Big Bend National Park, Texas and the Serranias del Burro, Coahuila, Mexico, 1991-94. Spec. Report Big Bend Nat. Park, TX. 40 pp.

McKinney, B. R., and M. T. Pittman. 1999. Habitat use, diet, home range, and movement of resident, and relocated black bears in a lower Chihuahuan Desert habitat. Wildlife Diversity Group, Project WER39 STATE. Texas Parks and Wildlife Department, Austin, Texas. 42 pp.

Additional References

Anderson, Tom. 1992. Black Bear: Seasons in the Wild. Voyageur Press, Inc. Stillwater, Minnesota. 120 pages.

Brown, Gary. 1993. The Great Bear Almanac. Lyons and Burford. New York, N.Y. 325 pages.

Cox, Daniel J. 1990. Black Bear. Chronicle Books. San Francisco, California. 96 pages.

Fair, Jeff. 1990. The Great American Bear. Northwood Press, Inc. Minocqua, Wisconsin. 192 pages.

Hererro, Stephen. 1985. Bear attacks: their causes and avoidance. Lyons and Burford. New York, N.Y. 287 pages.

*Prepared by Bonnie McKinney
Revised by Calvin Richardson*

APPENDIX O



Specific Management Recommendations for Rio Grande Turkeys

Rio Grande turkeys are present along a few riparian areas in Jeff Davis, Presidio, and Brewster counties, while they are widely distributed in Pecos and Terrell counties and in every county in the western Edwards Plateau. There is a general increase in numbers from

west to east. Turkey populations in Jeff Davis and Brewster counties currently support a spring only season, while turkeys in Pecos and Terrell counties provide fall and spring hunting.

Although turkeys are non-migratory resident species, they have large home ranges that change with the season of year. Turkeys tend to be widely dispersed during the spring and summer nesting/brood-rearing period. Nesting and brood-rearing habitat is similar to that required for quail, but on a larger scale -- scattered thickets of low growing brush, patchy residual herbaceous vegetation, and a diverse grass/forb plant community that produces seeds and insects.

After the breeding season, numerous smaller flocks that were widely dispersed during the summer tend to congregate into large winter flocks. The ranges of winter flocks are closely associated riparian areas (the floodplains of large creeks and rivers) that have moderately dense stands of brush and tall, full canopied trees. These winter flocks will disperse several miles from their riparian area roost sites on daily feeding forays. Turkeys are attracted to feeders and supplemental food plantings provided for deer and quail. The presence of turkeys on a ranch in the winter months is determined by the availability of a food source and the distance of the property from the winter roost site.

Like any other species, wild turkeys require quality food, water, and cover. The manner in which these key habitat components are distributed on the property are extremely important to the overall quality of the habitat. Turkeys require water daily and can obtain water from foods or free water (ponds, creeks, rivers, etc.) Grassy or brushy nesting and brood-rearing cover is probably the most important cover requirement. Food availability for turkeys can be increased by the following activities: (1) light to moderate livestock stocking rates (2) deferred rotation grazing system (3) control white-tailed deer numbers by harvesting does (4) prescribed fire can control brush encroachment (especially cedar and mesquite) and increase the production of grasses, legumes and other forbs, and promote fruit or mast production. In summary, range management activities that increase the diversity of grasses, forbs, shrubs, trees, and

vines improve the habitat for the wild turkeys. These same management practices are also beneficial to deer, quail, and many other wildlife species.

Protection of roosting sites is a key factor in the long-term maintenance of a turkey population. Turkeys also need moderately dense escape cover to travel to and from roosting sites. Mature trees used as roosting sites include sycamore, cottonwood, most large oaks, hackberry, pecan, western soapberry, and large mesquite. Dense brush thickets or large block clearings are generally detractors of quality turkey habitat. It is critical during brush management projects to leave strips of woody vegetation (especially along riparian habitats) between large cleared areas. When clearing brush, avoid removing hardwood trees such as the various species of oaks, hackberry, or large mesquite. Many wildlife/livestock managers implement brush management programs that establish irregular-shaped, cleared strips that follow the contour of the land. By removing brush only from the deeper soil below the rocky, shallow-soiled ridges (while staying away from riparian areas), brush management projects are more efficient and cost-effective in that they are achieving the greatest forage and herbaceous cover response per dollar invested. This “contour” or “mosaic” pattern provides a good mix of forage and cover that allows turkeys and other wildlife species to select the optimum arrangement that best satisfies their requirements.

High-energy supplemental feeds such as corn and sorghum provided during January through mid-March can help increase winter survival. Beginning in March, a gradual shift to high-protein pellets (20%) can also improve the reproductive performance of turkey hens. Supplemental plantings (wheat, oats, alfalfa) may be even more valuable in that they provide Vitamin A (required for egg production) and tend to harbor an abundance of protein-rich insects as the weather warms. Generally, supplemental plantings are applicable only in the eastern portion of the region, and in most years rainfall is insufficient to allow germination or adequate growth. During the infrequent year that rainfall is abundant, it is possible to successfully establish supplemental plantings. However, the rangeland forage conditions are normally so good during these years that the plantings are of little value. In the rare circumstance where irrigation is possible, plantings can be extremely valuable. During drought or even average rainfall years, irrigated plantings can provide a green “buffet” of nutrients that are otherwise scarce.

With regard to harvest, approximately 20% of the turkey population (estimated in late summer) can be harvested annually. Adjustments in the harvest can be made on an annual basis. These adjustments will depend upon the nesting success and range conditions.

For more information, refer to TPWD publication PWD RP W7100-263, *Rio Grande Turkey Habitat Management*, by George W. Litton and Fielding Harwell.

APPENDIX P



Specific Management Recommendations for Bobwhite Quail

Bobwhite quail occur throughout the western Edwards Plateau, and their distribution extends into eastern portions of the Trans-Pecos Region. However, their numbers decline dramatically from east to west in Ector, Crane, eastern Pecos, and Terrell counties. Along the western edge of bobwhite range, there is considerable overlap in distribution with its western “cousin”, the scaled quail (commonly known as blue quail). Bobwhite quail populations can fluctuate tremendously from year to year, even in the best quail-

producing areas of the state. The amount and timing of fall and winter rainfall is one of the most important factors determining quail production in the following year (adequate rains provide the soil moisture to promote early growth of herbaceous plants and insect production).

Basic Habitat Requirements

Bobwhite quail must have an adequate supply of food and reasonable protection from hazards on a year-round basis. This includes protection from predators while feeding, resting, loafing, roosting, traveling, and nesting, as well as protection from inclement weather conditions. Various food and cover types must be available during the entire year. If any requirement is lacking, even for a short period of time, the quail population will decline rapidly.

To be of benefit to quail, food and cover must occur in a well-arranged pattern. The distance between a food source and adequate cover must not be greater than bobwhites can negotiate with safety. Although bobwhites will venture up to 200 yards from cover, ideally escape cover should be linked to food supplies with more or less continuous screening cover. Quality screening cover adequately hides quail from potential predators but does not pose an obstacle to the quail's short-legged gait. Overgrazed pastures tend to provide poor screening cover. Conversely, dense stands of thick grass such as Old World bluestem or bermudagrass monocultures cannot easily be negotiated. Without a suitable space relationship between food and cover sources, the habitat will not be used by quail regardless of the quality or amount of food or cover present.

Food

Food supplies are most abundant during the spring and summer, as seeds and fruit are ripening and insects and green plants are available. For the nesting hen, tender green plants are essential in providing carotenes and Vitamin A, which are important to the hen in the egg development process. Another important food source for the nesting hen is insects. Insects are a rich source of protein and calcium, nutrients that are critical for yolk and eggshell development. Insect abundance is also a key factor in the survival of quail chicks, as they rely almost exclusively on insects during the first 3-4 weeks of life. Insects continue to be a critical source of protein for growing birds throughout the summer. Quail rely more heavily on seeds and fruit during late summer and fall. The food supply begins to diminish at the time of the first killing frost in the fall, and continues to decline throughout the winter due to weathering and competition from other animals. Seeds from forbs such as croton (doveweed), ragweed, sunflower, partridge pea, and others are staple winter foods. A number of woody plants also provide winter quail food. Fruits and mast such as small acorns, sumac berries, hackberries, prickly pear fruit, and bumelia berries supplement quail diets. Most grasses, except for bristlegrass, paspalums and panic grasses, do not produce seeds large enough to be worthwhile quail food. In general, forbs are the most important and most widely distributed sources of winter quail food. Green material from cool-season forbs and grasses that germinate in the late winter (provided rainfall is adequate) is essential for improving quail body condition before the upcoming breeding season.

Cover

Bobwhite quail need several types of cover: overhead and lateral screening cover for security while feeding and traveling, dense brush and/or weeds for escaping immediate danger/predators, loafing cover for dusting or resting, and nesting cover. Roosting cover is also needed, but if other types of cover are present, roosting cover is usually adequate.

Cover can take many forms and a patch of cover can meet several of the cover requirements. A stand of broomweed or similar plants (tall with bushy canopies and an open understory at ground level) can provide overhead screening cover. Thickets of low brush, trees, and vines can provide escape and loafing cover. In general, habitat with 10-15% canopy cover of low-growth woody plants is adequate, provided they occur in small, well-distributed clumps or patches. The better distributed various types of protective cover, the greater the useable space for obtaining other habitat components needed for survival.

For nesting cover, bobwhites seek out clumps and patches of residual grasses remaining from the previous growing season. The majority of nests are established in bunchgrasses such as sideoats grama and bluestems. Individual clumps should be at least 8 inches tall and 12 inches in diameter. Ideally, there should be more than 250 well-distributed clumps of suitable nesting cover per acre, or 1 clump every 15 to 20 steps. Too little nesting cover makes it easier for predators to find and destroy nests.

Habitat Management Recommendations

One of the keys to developing quality bobwhite habitat is creating or maintaining a mosaic of vegetation types throughout the ranch. This includes small thickets of low-growing brush, patches of bunchgrasses, and weedy areas with ample bare ground. Thickets of sumac, catclaw, lotebush, saltbush, foresteria, shinnery oak, and cactus should be retained and encouraged to develop. Although not as desirable, small clumps of low-growing cedars could have some value as cover where other species do not grow or are in short supply. Where vines have grown up into a tree, but cover at ground level is sparse, the tree trunk can be partially cut a few feet above ground so that the tree canopy can be pushed to the ground. This brings the living vines closer to the ground and provides excellent protective cover for quail. Young mesquite may be improved as overhead protective cover by a method known as *half-cutting*. This technique involves cutting half way through the branches (at a height of 3-4 feet) of smooth-barked, multi-stemmed mesquites and pushing them to the ground. If done properly, the branches will continue to grow, providing overhead and lateral cover for birds. In addition, the thorny branches protect grasses and forbs from grazing by livestock and deer, which will serve as quality nesting cover the following spring. Half-cutting mesquite should be done during the spring and summer when the sap is flowing and branches are flexible. The individual "skeletons" of large cut cedars can also form small areas protected from grazing/browsing where patches of herbaceous and woody plants suitable for cover can become established. The number of browsing animals on the range (combination of wildlife and domestic livestock) should be maintained at a level where browsing pressure on low growing woody cover is not excessive.

Another critical component of quality bobwhite habitat is herbaceous cover. A well-planned deferred-rotation livestock grazing system can be used to improve nesting cover or to create bobwhite foraging areas and brood habitat through high-stock-density disturbance. Heavy spot-grazing by cattle, such as occurs around salt blocks, feed areas, and water, causes soil disturbance that encourages forb growth. Salt blocks and feeding areas can be moved around the ranch to create small patches of disturbed ground.

Prescribed burning has been found to be an effective, low-cost habitat management tool that can be used to enhance plant diversity by stimulating production of a variety of woody plants, forbs, and grasses. Rangeland fires in early winter stimulate the production of cool-season annuals and perennial forbs, including a group of forbs referred to as "legumes" (pea family). This includes plant species such as velvet and Illinois bundleflower, partridge pea, western indigo, and rush-pea. Most legumes are excellent seed producers, and like other forbs, they tend to harbor an abundance of insects. Although an infrequent problem on most west Texas ranches, burning can be used to remove rank stands of herbaceous vegetation and plant litter that hinder quail movements. Other benefits of fire include increased palatability of forages, a temporary increase in plant nutrients (fertilization effect), and suppression of undesirable woody plants. To promote a good mixture of food and cover, burning under relatively cool conditions is generally recommended to obtain the desired "patchy" habitat effect.

Most good seed producing forbs are early-succession annuals (eg., ragweed, doveweed [croton], pigweed, sunflower) that respond to soil disturbance. Disking the soil to a depth of 3-6" is a practice that normally encourages the growth of annual forbs in areas with substantial grass cover. Too much grass is seldom a problem on most West Texas ranches, so this technique is probably not widely applicable in west Texas. Disking tends to be more effective on rangelands with a good to excellent stand of grasses and is less important on rangelands that already have patches of weeds and bare ground. In situations where the practice is appropriate, the disked strips should be long and meandering. They should be 15' to 30' wide and plowed along the contour of the land to minimize erosion. The same strips can be disked annually, or parallel strips may be disked on an alternating basis every other year to create adjacent strips in various stages of succession. The best plant response will occur in areas of deep sand or sandy-loam soils. It is important that disked strips be located near escape cover so they are useable by quail. Disking can be done anytime between the first killing frost in the fall and the last frost in the spring, but the optimum time is late February/early March, shortly before spring growth gets underway.

Managing the habitat for the production of native food plants and cover should be the primary management goal. Supplemental feeding and/or the planting of food plots are not a substitute for good habitat management. These practices should only be considered as "supplements" to the native habitat, not as "cure-alls" for low quality and/or poorly managed habitats. Food plots and feeders alone will not increase the number of quail that the habitat can support if other habitat components such as cover are limited.

Providing supplemental water is another popular quail management practice that seems very logical and practical but normally fails to produce a measurable difference in bird survival. During average and good rainfall years, quail will seldom use standing water. Insects (which are about 70-75% water) are abundant during spring, summer, and fall; and green vegetation (up to 90% water) is usually plentiful. Even dried grain and other seeds contain 5-10% water. During drought years, water sources will be substantially more limited and quail will take standing water more often, but increased drinking water will have little, if any, effect on overall bird numbers. The reason for this lack of response is that drinking water is not the limiting factor. There are many other environmental factors during drought that contribute to the decline in quail numbers. One of the primary factors responsible for the decline is a marked decrease in reproductive success. If drought conditions are severe, the birds may not even pair for breeding. If birds do pair, many nests are unsuccessful because the adults can not maintain adequate humidity around the incubating eggs (some soil moisture is normally required to achieve this). Green vegetation is sparse in dry weather, which directly affects the nesting hen because green plants provide essential nutrients (Vitamin A and water), and fewer green plants translates to fewer insects. Low insect abundance will not only affect egg production (source of calcium and protein) but will impact chick survival, as they require this high-protein food source during the first few weeks of life. Drought reduces escape cover and thermal cover, which increases quail exposure to

predation and weather extremes. In addition, reduced populations of buffer species (small mammals) may increase predation intensity on quail. One of the greatest impacts of drought on quail production, especially on rangelands grazed by livestock, is reduced cover for nesting. The absence of quality nesting cover (reduced growth and grazing pressure) may be the greatest limiting factor for quail populations in west Texas.

Drinking water may help a bird to survive another day, but it will not “save” the nesting season, which is the foundation of a quail population in any given year. One of the most effective means of providing supplemental water for quail in a drought is through windmill and trough overflows and pipeline “leaks”. These areas, although small, provide drinking water, soil moisture, green forage, vegetative cover, and insects that may allow the successful reproduction of a few extra quail pairs.

In summary, good quail habitat will provide seasonally important foods and various types of cover on a year-round basis, and these components will occur in a suitable arrangement (patchwork) to optimize habitat use. The number of quail that a habitat can produce and support will depend on the habitat component that is most limited. In other words, if woody cover or nesting cover is the limiting factor, quail production will not increase regardless of how much supplemental food and water is provided.

References:

TPWD brochure 7000-37, *Bobwhite Quail in Texas, Habitat Needs & Management Suggestions* by A.S. Jackson, C. Holt, and D. W. Lay.

TPWD Bulletin #48, *Quail Management Handbook for West Texas Rolling Plains*, by A. S. Jackson.

A 182 page book *Beef, Brush and Bobwhites* by F. S. Guthery (1986). Caesar Kleberg Wildlife Research Institute, Texas A&I University.

APPENDIX Q

Specific Management Recommendations for Scaled Quail

Of the four species of quail occurring in the Trans-Pecos (bobwhite, scaled, Mearn's, and Gambel's), the scaled quail is the most common and widely distributed species. In the Trans-Pecos, scaled quail are more commonly known as "blue" quail (referring to their blue-gray feathers) or "cottontop" (referring to their white crest). Scaled quail management is often limited to scattering a handful of grain, with few management efforts directed at enhancing the bird's habitat. For managers interested in improving quail habitat, it is important to be able to recognize the essential needs of the species and to have a basic understanding of how weather and land management practices affect scaled quail habitat. It is also important for managers to realize that factors beyond their control, such as the timing and amount of fall and winter precipitation, have a tremendous influence on quail breeding success and survival through the next year.



HABITAT REQUIREMENTS

The presence and abundance of scaled quail is directly related to the quantity and quality of habitat components – food, cover, and water. Scaled quail must have a year-round supply of food and adequate protection from the elements. This includes protection from predators and weather while nesting, feeding, loafing, and roosting. In quality habitat, food and cover patches occur within close proximity of one another.

Food

Scaled quail eat a wide variety of foods, with seasonal availability and the bird's physiological needs being the major factors affecting diet composition. Food items can be separated into 4 categories: 1) seeds, 2) succulent fruits, 3) green leafy material, and 4) insects. From October through March up to 70% of the diet may be comprised of seeds. Some of the major seed-producing plants include ragweed, croton, sunflower, senna, tasajillo, prickly pear, mesquite, broomweed, pigweed, snakeweed, sandlilly and prickly poppy. Many of these plants are regarded simply as "weeds" to the landowner, but they represent a nutritious buffet for scaled quail. It is critical for quail managers to

be able to identify the major plant species and to predict their responses to land management techniques.

Grasses typically contribute little to the food requirements of scaled quail, although bristleglass, paspalums and panic grasses, which have relatively large, smooth seeds, can be the exception in some areas. Cultivated "grasses" like sorghums and wheat can also be important quail foods. Green leafy materials are mostly consumed during the spring and summer months. Succulent fruits are generally available in late summer and fall.

Insects are the perfect quail food and are especially important during spring and summer. Insects provide protein, water, and important minerals such as calcium. Each of these nutrients is required in substantial amounts by the quail hen in the egg development process. Insects are especially important to quail chicks, as they require a diet consisting of about 28% protein during their first 10 weeks of life. This level of protein is not obtainable on a diet of seeds, fruits, and greens.

Cover

Due to the harsh environment often associated with scaled quail habitat, quality cover is just as critical as abundant food sources. Although relatively unimportant in scaled quail diets, grasses are very important as nesting cover. Nests of scaled quail are commonly located in shallow depressions in the ground, lined with residual grasses or other vegetative matter. These nests are usually associated with some type of brushy cover or nestled within a clump of prickly pear cactus.

The feeding behavior of quail resembles that of a barnyard chicken, as they scratch the ground in search of food (seeds and insects). Bare ground is an important element in scaled quail habitat, although adequate bare ground is seldom a problem over most parts of their range. An exception may be in improved pastures and CRP fields where grass cover may be too dense. Excessive grass cover can impede a quail's mobility, especially chicks, and interfere with their ability to visually locate food.

Areas of broomweed and ragweed provide excellent feeding and brood-rearing cover. In addition to the seeds they produce, their growth form (single stem, branched canopy) provides good overhead cover. Loafing cover must provide overhead protection and be open at ground level. This cover type can be in the form of old machinery, tangled brush thickets, tall and spreading cacti, or dense patches of coarse weeds. It can also serve as escape cover, providing protection from predators. Some of the major brush species used for loafing cover are lotebush, catclaw, littleleaf sumac, skunkbush sumac, algerita, shinnery oak, sand sage, mesquite, and taller forms of prickly pear and cholla.

Roosting cover is seldom deficient in scaled quail country. Scaled quail prefer open areas with little overhead cover so that they can make explosive flushes when disturbed without interference from overhead branches or other obstacles.

Water

Scaled quail evolved in a region where water was scarce, if not absent, over much of its range. Although watering sites attract quail and may be the focal point of their daily movements, there is no evidence that providing water sources will produce long-term population increases. While surface water may be used when available, scaled quail are able to meet their water needs from dew, succulent leaves and fruits, and insects. Some scaled quail coveys will adjust their daily activity patterns to include visiting watering sites; however, other coveys will exist for long periods without drinking surface water. Available surface water attracts quail and may help in reproduction, but apparently scaled quail can and do survive without it. During extended drought, when succulent greens are absent and summer temperatures are in excess of 100°F, free-standing water may be more critical.

HABITAT MANAGEMENT RECOMMENDATIONS

Numerous publications are available on bobwhite quail management, and most of them list an array of habitat management techniques designed to improve quail habitat. However, these management techniques were designed for implementation in areas that lie east of the Trans-Pecos. Few of these practices are applicable to scaled quail habitat. Most scaled quail ranges receive less than 18 inches of rainfall per year. Low amounts of rainfall in the Trans-Pecos and, perhaps more importantly, unpredictable rainfall decreases the success of habitat management practices common on bobwhite ranges.

Food Plots

Scaled quail foods are seldom limiting in the Trans-Pecos. Even during extended drought, problems with nesting cover, escape cover, water, egg production, and chick survival occur long before food sources decline. With low and often erratic precipitation patterns in the Trans-Pecos, food plot establishment is undependable unless irrigation is available. Scaled quail will generally benefit from irrigated food plots of sorghum or wheat when located adjacent to suitable escape cover (combined benefits of seed, insects, cover, and ground moisture).

Cultivation Practices

In cropland areas, leaving strips or rows of grain crops along field borders, turn-rows, terraces, fence-rows, and odd corners can benefit scaled quail. Not only will these strips provide abundant seed, but they will provide protective travel corridors. Leaving odd corners in standing crops or allowing them to grow into weedy patches will provide additional sources of food and cover.

Soil Disturbance

Most native food plants used by scaled quail are stimulated by soil disturbance. One of

the most effective methods of stimulating growth of native foods is late winter disking. This method tends to be more effective in areas with at least 14 inches of average annual rainfall and should be conducted in late February or early March before the last frost. Disking should be conducted at a depth of 3-6 inches, and the response on sandy soils is considerably greater than on clay soils. The disked strips should be located adjacent to woody cover such as field borders, fence-rows, brushy drainages, wooded gullies, and even along existing ranch and pasture roads. These weedy patches produce abundant seeds and harbor a variety of insects.

Livestock grazing is an alternative method of stimulating forb production. By using an attractant (feed or hay) in key areas, hoof action from high stock densities can disturb the soil, thus allowing low succession plants to germinate. Cattle grazing should be rotated among pastures to let the forbs in these spot-grazed areas to germinate and establish.

Supplemental Feeding

Supplemental feeding is a popular practice in quail management, but several studies have shown that feeding alone does not result in increased numbers of quail. The primary reason is that food is seldom the factor limiting population density. In the rare situation that food was the limiting factor, feed should be available to all birds in a population and located near cover. This could mean locating a feeder every ¼ mile throughout the property.

Water Development

Providing water at windmill sites and constructing ponds and spreader dams may benefit scaled quail. Water should be made available at ground level, on gentle slopes, and close to cover. Overflow from windmills or troughs can be directed to ground level dugouts or cement saucers. Tapping into an existing livestock water pipeline and utilizing drip irrigation emitters is an easy way to provide water for scaled quail.

Brush Management

When planning brush management, the manager should consider the treatment method, clearing size, areas of mid- and tall-grasses, availability of native foods, and the spatial arrangements of these habitat components. Although a critical habitat requirement, scaled quail require relatively low densities of woody cover. Maintaining 10 – 20 % brush cover is suitable to meet their requirements, provided it is the proper kind of cover (low-growing). In areas managed for mule deer and scaled quail, brush canopies should be maintained at about 25 – 30 %. Mosaic patterns of brush provides a lot of “edge” and tend to be more beneficial to quail than strips of brush. Small patches or brush strips are more beneficial than large blocks of brush and openings.

In areas where woody cover is absent, artificial methods of developing cover can be employed. “Teepees”, erected by standing fence posts against one another (stabilized

with wire), can be important sources of escape cover and shade. A more durable type of artificial shelter can be constructed by placing 3 or 4 fence posts in the ground 8 to 12 feet apart and cutting them off 10 to 15 inches above the ground. Strands of wire, or wire netting is used to construct a base across the top of the posts before brush is piled on top. The wire keeps the brush off the ground so that birds can easily enter and leave the shelter. The most long-term technique involves planting woody species (and allowing natural propagation) such as lotebush, plum, skunkbush, and four-winged saltbush. Some areas are devoid of quality, low-growth woody species but have abundant woody shrubs with an upright growth-form, such as mesquite. The quality of these shrubs as escape and loafing cover can be greatly improved through a technique called "half-cutting". Half-cutting involves cutting half way through the top sides of branches (at a height of 3-4 feet) so that they can be bent down toward the ground. This technique is most successful if conducted in late spring and summer, using smooth-bark mesquites with flexible limbs.

Prescribed Burning

Prescribed burns are conducted to meet a land management objective under specific climatic and environmental prescriptions for relative humidity, air temperature, season, soil moisture, wind speed and direction, and fuel load. The desired plant response and ultimately the type of burn to be applied will depend on range, livestock, and wildlife management objectives. Most plants subjected to periodic top removal through fire or grazing are more vigorous and productive than plants that are "protected". Removing old growth and litter from bunchgrasses helps to increase production of new leaves, which are important in replenishing the roots with starches and carbohydrates through photosynthesis. Other benefits of fire include increased palatability of forages, a temporary increase in plant nutrients, and suppression of undesirable species or densities of woody plants.

Rangeland fires can stimulate the germination of annual and perennial forbs, including a group of forbs referred to as "legumes" (pea family). This includes plant species such as partridge pea, bundleflower, western indigo, and sensitivebriar. Legumes are extremely important to quail and other birds in that they are some of the best seed producers. Perhaps even more important, legumes and other forbs attract an abundance of insects. The hen relies upon insects for protein and calcium and as a water source prior to and during nesting. The young chicks are solely dependent upon insects for food during their first 8-10 weeks of life.

The most beneficial burning programs for quail incorporate a multi-year rotation so that 10-15% of the property is burned each year. This schedule allows 7 to 10 years between burns for any given area. For larger ranches, it is more beneficial to burn several smaller blocks each year than one large block. This method will provide a diverse pattern of food and cover at various stages of growth. When burning in smaller blocks is not practical, a single burn conducted under relatively "cool" conditions (lower temperature, higher humidity) will generally produce a mosaic of burned and unburned areas. This technique maintains critical nesting cover while increasing edge and

promoting annual weeds and grasses.

Grazing Management

Proper grazing and range management can do more for scaled quail habitat in West Texas than any other management practice discussed. Generally, cattle grazing under light to moderate stocking rates in a deferred-rotation grazing program is beneficial to scaled quail. Also, grazing by sheep and goats at light stocking rates is generally compatible with scaled quail management. However, moderate to heavy numbers of sheep and goats tend to reduce the supply of native quail foods and the amount of low-growing woody brush that is critical for quail cover. Overgrazing by any kind of livestock severely reduces nesting cover and quail food diversity in West Texas.

Summary

Scaled quail can be difficult to manage because of population fluctuations inherent within the species and the limitations imposed by a harsh environment on habitat management techniques. Implementing every available quail management practice will not assure high quail numbers – quail production is too dependent on timely rainfall. However, the successful manager is able to take advantage of the good moisture years by following the basics: 1) maintaining adequate nesting cover, 2) maintaining proper densities of low-growing brush, 3) and maintaining a diversity of food plants. This can be accomplished with light to moderate stocking rates, deferred-rotational grazing, selective brush management, and sometimes prescribed fire. Although quail numbers will be depressed during poor rainfall years, higher survival rates can be realized on ranches that provide scaled quail with their basic habitat requirements. These populations tend to be more resilient with the return of favorable conditions and respond faster than quail on overgrazed ranges with low-quality woody cover.

APPENDIX R

Specific Management Recommendations for Gambel's Quail

The Gambel's quail (*Callipepla gambelii*), also known as the Arizona or desert quail, is an uncommon but beautiful addition to Texas' diverse array of birds. This handsome, unique game bird is found in the Mojave, Sonoran, and Chihuahuan Deserts of the southwestern United States. In Texas, the Gambel's quail is limited to the upper Rio Grande and associated drainages of the Far Western region of the State.

Immediately recognized by its teardrop-shaped topknot (crest), the Gambel's quail is easily distinguished from its Trans-Pecos cousins, the scaled or blue quail (*Callipepla squamata*) and the Montezuma, Mearn's, or harlequin quail (*Cyrtonyx montezumae*).



The Gambel's and scaled quail are the only quail species that typically inhabit the mesquite, acacia and creosote vegetative community. Unique to Gambel's quail in Texas is a tendency for covey members to roost in trees associated with desert riparian areas.

Male Gambel's quail are generally brown to grayish brown on the upper parts and tail, with buffy underparts and an extensive black area on the abdomen. They also have a characteristic black throat and forehead that is absent in females. The distinctive topknot is black in males and dark brown in females. Females are less impressive looking than males, with some streaking possible on the breast. Both sexes have a distinctive rich reddish-brown coloration on the flanks. Adults are about 9 ½ to 11 inches long.

Gambel's quail have a unique location call that can be best described as a nasal *chi-CA-go-go*. This sound often can be heard after a covey is flushed and the birds attempt to locate each other. Individuals also make a repeated *chip-chip-chip* sound when alarmed and a loud squawk when flushed.

Male Gambel's quail also make a loud *kaa* call during April, May, and June—apparently to attract mates. Males often can be seen in a characteristic erect posture, with upright crest, making this call from an exposed perch. Males chase each other and fight during

this period in order to establish a system of social dominance. Once pair bonds form, Gambel's quail are strongly monogamous, remaining together though out the rest of the year. In April and May, the female lays one egg per day in a shallow depression on the ground that is typically concealed by grass until the clutch of 12-14 eggs is complete. The female incubates the eggs for 21-23 days while the male typically stands guard nearby.

After the eggs hatch, young birds are up and running within hours. The first few weeks of life are most important for quail chicks. Mortality is typically high during this period because of starvation and predation. Less common but potentially devastating causes of mortality are torrential thunderstorms and hailstorms.

A high protein diet of insects is an integral part of an adult quail diet in the spring and is critical for the survival and growth of young quail. The sporadic precipitation patterns associated with desert communities do not always guarantee that insects will be available during this critical period. Thus, few chicks may survive the first four to six weeks of life. Factors that reduce the availability of insects, such as a late spring freeze, can have a detrimental effect on chick survival. A late first freeze in the fall may allow insects additional time to lay eggs, which could translate to increased insect abundance the following spring and enhanced quail chick survival.

If forage conditions are favorable, adults "wean" the chicks at about one month of age, leave them in the care of older birds in the area, and begin a second clutch. Infrequently, the male takes over care of the brood while the female begins another clutch.

As they mature, young Gambel's quail begin to eat green leaves and other succulent vegetation and will eventually consume plant matter almost exclusively. Leafy materials from forbs (broadleaf weeds) and tender grass shoots are the most important food sources for Gambel's quail, particularly the leaves, flowers, and seeds of legumes. However, during periods of drought or when surface water and green, herbaceous vegetation is lacking, Gambel's quail depend heavily on succulent desert vegetation such as shrubs, cacti, and their fruit. These plants provide an important source of moisture and minimize their need for free water.

Coveys of Gambel's quail are typically composed of the parents and their brood(s) that stay together through the winter. However, family groups sometimes combine to form a large covey. Single birds may organize into their own covey or join a family covey. Single birds or pairs are rarely observed during the fall and winter. With arrival of spring, coveys break down and pair bonds begin to form again.

Beneficial Habitat Management Practices

Gambel's quail require a diverse pattern of vegetation to supply them with various foods they need throughout the year. This is especially true during droughts. In the Trans-Pecos region of Texas, a critical period for moisture and the associated food supply typically occurs from January through April. Both shrubs and forbs are important

components of this vegetation diversity. Sandy washes and/or drainage's supporting honey mesquite, skunkbush sumac, littleleaf sumac, whitethorn acacia, juniper, allthorn, catclaw and yucca provide excellent cover and feeding habitat for Gambel's quail. Based on these desirable habitat characteristics, landowners and managers can implement the following practices to increase Gambel's quail abundance, distribution, and survival:

- Implement a grazing system that provides planned periodic rest for pastures. Deferred-rotational grazing helps prevent overgrazing of forbs. Snakeweed and Russian thistle are important Gambel's quail food items and react positively to *light to moderate* livestock grazing.
- Design fencing to facilitate deferred-rotational grazing. Fencing is especially important in controlling the timing and duration of grazing in riparian areas. Total deferment of riparian areas from grazing may be appropriate in some years. A fine line exists between habitat enhancement and habitat destruction. Livestock grazing and mechanical or chemical control of native vegetation in west Texas can be favorable for quail when properly conducted. See your local Wildlife Biologist or Natural Resource Conservation Service staff for recommendations.
- Implement practices that minimize precipitation runoff. This will limit soil erosion, improve soil moisture, and increase plant growth. These practices might include dike/levee construction, installation of diversion dams and berms, and gully shaping to hold rainfall and catch runoff.
- Conduct shallow winter disking on approximately 1-3% of the quail habitat before the last freeze to stimulate forb production. Late winter disking promotes annual grasses and seed-producing forbs, which can be valuable not only to Gambel's quail but to scaled quail, doves, and other seed-eating birds. These patches of forbs also tend to harbor an abundance of insects that serve as forage for a variety of birds. The disked strips should be located in deeper soils adjacent to drainages and washes commonly used by Gambel's quail. Disking should be conducted at a depth of 4 - 6" along the contour (usually perpendicular to drainage or wash) and only in areas where the slope does not exceed 3% (preferably less than 1%).
- Livestock watering facilities often are adequate water sources for Gambel's quail, but quail prefer free water at ground level. Most standard livestock troughs require some type of ramp system that will provide easy access and escape for both young and adult birds. A wire-mesh screen or rock type ramp on the inside and outside of the trough works well. Ground level troughs are superior in that they provide the birds with easy access to water and reduce exposure to predators. However, a drip or overflow system that allows water to reach the soil has the added advantage of promoting succulent green vegetation and insects. Any watering facility developed for quail use should be located near woody cover to minimize exposure to predators. Concerning water distribution, limited research indicates that Gambel's quail will forage 1.5 miles or less from available water during prolonged drought periods. Most coveys stay within a mile of a water source.

- Use prescribed fire to stimulate the germination of annual and perennial forbs, including a group of forbs referred to as “legumes” (pea family). Legumes are extremely important to quail and other birds in that they are some of the best seed producers. Just as important, legumes and other forbs tend to support an abundance of insects. Fire tends to favor bunchgrass over shallow-rooted, sod-forming grasses and can suppress undesirable species or densities of woody plants. The most beneficial burning programs for quail incorporate a multi-year rotation so that approximately 10% of the property is burned each year. This schedule allows for 7 to 12 years between burns for any given area and prevents the removal of cover over an extensive area.

In Texas, Gambel’s quail are classified as upland gamebirds that may be hunted during quail season by those having a valid hunting license. Whether you’re a hunter, landowner, bird watcher, or just someone who enjoys looking at a unique part of Texas’ bird fauna, take outdoor time to enjoy this little jewel of the desert.

APPENDIX S

Nongame Wildlife Management Recommendations

This document provides a brief description of habitats and various management practices that are beneficial to nongame species of wildlife. Refer to guidelines provided through TPWD's Texas Wildscapes Program for specific practices to provide food, water and cover requirements for various nongame species. It should be noted that many of the recommended practices are also beneficial to game species (e.g., deer, dove, turkey, quail, etc.). Conversely, most management practices directed at managing game species will also benefit many species of nongame wildlife.

HABITAT CONTROL

Grassland restoration - Establishing a mixture of native grasses and forbs on disturbed range or farmland to provide habitat for wildlife diversity. Use the TPWD wildscape plant list. Restore and maintain short and mixed grass sites by planting native seed stock, using species such as little bluestem, switchgrass, plains bristlegass, green sprangletop, sideoats grama, and other mixed grama species. Follow guidelines in Appendix U. Reduce woody plants near restored blocks of prairie to reduce incidence of predators and cowbirds. Use prescribed burning or apply selective herbicides in late summer or early fall using individual plant treatments according to recommendations provided by Texas A&M University Extension Service, Natural Resource Conservation Service and local Fire Department protocols. Summer burns are more effective at woody plant control, but extensive prescribed burns should be avoided during the nesting season. Prescribed burning in early summer may be necessary to improve the vegetation composition and structure, but a rotational burning program (relatively small patches are burned each year) should not significantly impact local bird species and other nongame wildlife. Proper grazing management is extremely important to improve security cover, nesting habitat, and food availability. In addition to monitoring grass height and cover, land managers should periodically evaluate the degree of use on shrubs by livestock and wildlife. Heavy utilization on shrub species can result in a loss of nesting habitat and food availability. Grass height of 4-12 inches is desirable for feeding and nesting cover of ground-nesting birds. Avoid fragmenting large blocks of habitat. "Area-sensitive" grassland species benefit from tracts of 125-250 acres or more in size. Expand the size and value of desert grasslands by restoring connecting corridors between small, disjointed grasslands. If this is not possible, restore small grassland plots of 15-20 acres located within a mile of each other.

Shrubland restoration – Establishing native shrubs or small trees where appropriate to restore native habitats for wildlife diversity. Use the TPWD Wildscapes plant list. Early-successional habitats can be provided by establishing hedgerows or plots of fruit-bearing native shrubs. Maintain brush along fencelines or shelterbelts with saplings and dense thickets of shrubs and vines for nongame birds such as the loggerhead shrike and blue grosbeak.

Wetland restoration - Establishing water flows and native vegetation in former wetlands to provide wildlife habitat.

Riparian area management - Provide alternate livestock feeding and watering sites, exclude pastures with riparian areas from livestock grazing or fence out livestock. Defer grazing in riparian areas during April- October.

Prescribed burning - The use of fire to restore, enhance or maintain native habitats for wildlife diversity. Prescribed burns should be conducted according to TPWD, USDA Natural Resource Conservation Service, Texas Agricultural Extension Service and Texas Natural Resource Conservation Commission protocols in coordination with the local Fire Department.

Exotic or "weedy" plant control - Use of fire, selective herbicides, and mechanical methods to control invasive plants in important habitat types to maintain or restore wildlife populations.

Conversion of exotic vegetation - Removal and replacement of exotic vegetation with native plants for wildlife habitat.

Restoration and maintenance of desert shrub/grasslands - Prescribed burns should only be conducted according to TPWD, USDA Natural Resources Conservation Service, Texas Agricultural Extension Service, and Texas Natural Resource Conservation Commission protocols in coordination with local Fire Department. Most prescribed burns are conducted during December-March. Late winter-early spring burns will not impact cool season forbs as much as mid-winter burns. Summer burns (June) are more risky, but are more effective at woody plant control. If mechanical brush control is used, leave brush piles for small mammals. Reseed areas with native grass/forb mixtures as necessary.

Maintain riparian areas with dense understory - Exclude livestock during summer and fall growing season. This allows for understory regeneration and mast (fruit) production. Severely overgrazed riparian areas may initially require several years of year-round deferment from grazing. Maintain dense horizontal layers of understory vegetation for nesting warblers, vireos and other songbirds. Connect fragmented blocks of habitat by planting a diversity of native, fruit-bearing trees and shrubs.

Enhance mid-succession brush/shinnery habitat - Promote brush regeneration with prescribed fire and/or mechanical methods that remove the top-growth of woody plants and encourage root sprouting. Use proper grazing management to avoid overuse of sprouting shrubs.

Protect karst, caves and other underground resources - Construct appropriate cave gates or other features to minimize human disturbance to roosting bats. Insure quality underground water resources through proper disposal of toxicants and runoff management. Maintain unobstructed cave entrance for easy access by bats.

EROSION CONTROL

Riparian area management - Provide alternate livestock feeding and watering sites, exclude pastures with riparian areas from livestock grazing or fence out livestock. Defer grazing in riparian areas during April- October. Control erosion using water structures and native plants.

Grassland restoration - Establishing a mixture of native grasses and forbs on disturbed range or farmland to provide habitat for wildlife diversity. Use the TPWD Wildscapes plant list.

Riparian/Upland habitat restoration - Establishing native trees and shrubs where appropriate to restore native habitats for wildlife diversity. Use the TPWD Wildscapes plant list.

PREDATOR CONTROL

Avian predator and nest parasite control – Selected avian predators (grackles, starlings, and brown-headed cowbirds) may be controlled as a part of a PLANNED PROGRAM to reduce impacts on nesting neotropical and resident songbirds through shooting and trapping, grazing management, and maintenance of large blocks of wildlife habitat.

Carnivore/furbearer control - Reduce the impact of coyotes, foxes, raccoons and other carnivores on colonial nesting birds. Control of feral dogs and cats by humane methods can enhance grassland bird nesting success and survival.

Fire ant control - Control fire ants using bait (such as Logic) or other approved product during spring-fall.

PROVIDING SUPPLEMENTAL WATER

Wetland restoration - Establishing water flows and native vegetation in altered coastal and inland wetlands.

Well/trough/pond with overflows - Establish additional shallow water supplies through construction of ground-level wildlife ponds, or adding overflow systems on existing wells and troughs. Protect these areas from livestock use. Follow TPWD Wildscapes Program guidelines and guidelines in Appendix O.

PROVIDING SUPPLEMENTAL FOOD

Establish food plots ½ to 1 acre in size by shallow-discing to promote native, seed-producing food plants for birds (i.e., sunflower, ragweed, croton, bundleflower, pigweed, etc.). Where irrigation is an option, consider supplementing native forage with 1 to 5

acre plots of small grains (e.g., wheat, oats, sorghum, millet, etc.).

Butterfly and hummingbird gardens - Establish native wildflowers, trees, shrubs, vines, or cultivated flowers as food sources for butterflies and hummingbirds. Follow the TPWD Wildscapes Program plant list.

Feeding stations - Set up liquid, seed and free-choice feeding stations for resident and migratory birds. Especially critical during migration and winter months when natural food sources are scarce. Follow TPWD Wildscapes Program guidelines.

Reduction of broadcast insecticides - Increases the amount of insects available as a wildlife food source for birds, reptiles and amphibians.

Conversion of exotic vegetation - Removal and replacement of exotic vegetation with native plants for wildlife habitat.

PROVIDING SUPPLEMENTAL SHELTER

Brush piles/rock piles - Leaving or stacking cleared brush and rocks to create denning and escape cover for birds, small mammals, reptiles and amphibians. Follow TPWD Wildscapes Program guidelines.

Thickets of native brush - Create or maintain thickets of native shrubs/trees for refuge.

Grassland restoration - Establishing a mixture of native grasses and forbs on disturbed range or farmland to provide habitat for wildlife diversity. Use the TPWD wildscape plant list.

Snag maintenance and creation - Protect snags and deadfalls for cavity-dwelling species. Create snags by using selective herbicides or girdling on undesirable woody plants.

Nest boxes and perching platforms/poles - Provide nest structures for songbirds, owls, small mammals, bats, raptors, herons, and other nongame species. In many areas dead timber snags, which provide cavities or natural hollows, are absent or rare. Where suitable nest cavities are in short supply, artificial nest/roost boxes can be erected to help alleviate these shortages for particular species. Some of the birds and mammals that can benefit from these structures are: bluebirds, chickadees, titmice, prothonotary warbler, wrens, woodpeckers, screech owls, kestrels, squirrels, and bats. The TPWD Wildscapes Program can furnish additional information regarding number, specifications, placement, and maintenance of these structures for specific species.

CENSUS

Time area counts - The number of individual species seen or heard during a fixed time frame per unit area (eg., point counts for birds, squirrels).

Drift fences/pit fall traps - A system of flashing or similar material arranged on the ground to funnel small wildlife species into buried buckets or other pitfall trap. (used primarily for reptiles and amphibians).

Small mammal traps - Small live traps arranged along a trapline to sample small mammals.

Other or Indicator Species: Bobwhite quail, dove, and wild turkey may be desired game species to have in the area, which may be expressed in the overall objective. The land management techniques that have been recommended primarily for the deer population (**Appendix G and H**) can benefit these game birds and many other non-game species of wildlife. These are: prescribed burning, disking, proper water distribution, livestock rotation or time-specific exclusion from woods and certain native grass areas, and supplemental food plots. See **Appendix (P and Q)** for more information on quail and **Appendix O** for turkey.

Nest/Roost boxes for Cavity Nesters/Roosters: Where suitable nest cavities are in short supply because of limited dead timber snags that provide cavities or natural timber hollows, artificial nest/roost boxes can be erected to help alleviate these shortages for particular species. Some of the birds and mammals that can benefit from these structures are: bluebirds, chickadees, titmice, prothonotary warbler, wrens, woodpeckers, screech owls, kestrels, wood ducks, black-bellied whistling ducks, squirrels, and bats. The TPWD Nongame and Urban Program can furnish additional information regarding number, specifications, placement, and maintenance of these structures for specific species.

Neotropical Migratory Birds: These are birds that breed in the United States and Canada, and migrate to the Neotropical regions of Mexico, Central and South America, and the Caribbean during the nonbreeding season. As mentioned in the General Habitat Management section at the beginning of this example plan, loss and fragmentation of woodland and native grassland habitat has reduced populations of many neotropical populations. Neotropicals include the following groups of birds: kites, hawks, falcons, owls, cuckoos, nightjars, hummingbirds, flycatchers, swallows, thrushes, vireos, warblers, tanagers, grosbeaks, buntings, sparrows, orioles, and blackbirds. For more information regarding neotropical status, surveys, and possible management strategies, contact the Partners in Flight Program Coordinator at TPWD Headquarters in Austin.

Birds of management concern for the Trans-Pecos region include:

A. Shrublands (Various Types)

Black-capped Vireo (SR)

Lucifer Hummingbird (SR)

Bell's Vireo (SR)

Scaled Quail (PR)

Lucy's Warbler (SR)
Black-chinned Hummingbird (SR)
Crissal Thrasher (PR)
Canyon Towhee (PR)
Cassin's Sparrow (SR)
Varied Bunting (PR*)
Black-tailed Gnatcatcher (PR)
Black Chinned Sparrow (PR*)
Scott's Oriole (SR)

B. Pinyon-Juniper woodlands/savannahs

Montezuma (Mearn's) Quail (PR)
Gray Vireo (SR)
Elf Owl (PR*)
Cassin's Kingbird (SR)

C. Grasslands

Aplomado Falcon (extirpated from Trans-Pecos for 40 years, but birds may still exist in the Marfa-Van Horn basin)
Burrowing Owl (PR)

D. Riparian Areas

Willow Flycatcher (Southwestern subspecies; MI, possibly nesting)
Common Black-Hawk (SR)
Gray Hawk (PR)
Elf Owl (SR)

E. Highland mixed conifers

Spotted Owl (Mexican subspecies; PR)
Colima Warbler (SR)

F. Rocky ledges and cliff faces

Peregrine Falcon (American subspecies; PR)

Legend:

PR- Permanent Resident (year round)
PR*- Numbers of individuals *decrease* during the winter months
SR- Summer Residents (only here during nesting)
MI- Migrant (only fall and/or spring time passage)

Waterfowl/Wading Birds: To improve the habitat for dabbling ducks and wading birds, construction of 3- 4 foot high levees with a drop-board water control structure in suitable low areas could back up and hold water during the winter months or the summer months, depending on water management strategy. This could provide shallow-water

(6 to 24 inches) feeding areas for migrant ducks, wading birds, and spring-nesting wood ducks. Exclude livestock from this area with installation of an electric or barbed wire fence around the perimeter, at least 50 yards upland from the maximum flooded area. Contact the local Natural Resources Conservation Service or TPWD waterfowl biologist for assistance in location and construction of the levee.

Exotic Species: Over-browsing of shrubs by non-native species such as aoudad, corsican and mouflan sheep can have a detrimental impact on nesting and forage availability for many songbirds. Many species of birds utilize the lower and mid-portions of shrubs, and it is these areas that are hardest hit by browsing animals.

Feral Hogs: Wild hogs do not occur in all areas of the Trans-Pecos, but where they do occur, they should be controlled by shooting and live trapping whenever possible. Control efforts are most successful when conducted during the winter when feral hogs have to travel more to find food, or during summer droughts when they tend to concentrate around available sources of water. Besides rooting up pastures, feral hogs compete directly with deer, turkey and most other wildlife species that rely heavily on acorns and other hard and soft mast for winter food. Deer also tend to avoid areas when feral hogs are present. Studies have revealed that several species of snakes and lizards are included in the diet of feral hogs.

Other Comments: The development of a Landowner Wildlife Management Association with adjacent and neighboring landowners will greatly enhance any management practices that are conducted on your property. TPWD and TCE personnel are available to assist in the establishment of landowner associations.

APPENDIX T

Specific Management Recommendations for Endangered Species

The following information and management guidelines are from the 130 page book "Endangered and Threatened Animals of Texas - Their Life History and Management", by Linda Campbell. Published by the Texas Parks and Wildlife Press, Austin, Texas in 1995. Distributed by the University of Texas Press, Austin, Texas, and revised in 2003 as an electronic book available on the TPWD website at www.tpwd.state.tx.us.

Black-capped Vireo



Scientific Name: *Vireo atricapillus*

Federal Status: Endangered, 10/6/87 • State

Status: Endangered

Description

The Black-capped Vireo is a 4.5 inch insect-eating songbird. Mature males are olive green above and white below with faint greenish-yellow flanks. The crown and back of the head is black with a partial white eyering. The iris is brownish-red and the bill black. The plumage on the back of the female is

duller than the male. Females have a medium to dark gray head with a blackish ring around the white surrounding the eye (this generally distinguishes the female from the second year male).

Distribution and Habitat

Historical records from 1852-1956 show that the Black-capped Vireo once occurred and nested from central Kansas, Oklahoma, Texas and into northern Mexico. Today, Blackcapped Vireos are known to nest in central and southwest Texas, a few counties in central Oklahoma, and in Coahuila and Nuevo Leon, Mexico, although less is known of their status in Mexico. Black-capped Vireos winter along the western coast of Mexico.

The descriptions of habitat presented in this document are intended to help landowners determine if they have Black-capped Vireo habitat on their property. Not all sites within the habitat types described will be used by Black-capped Vireos. It is only where individuals of this species occupy the identified habitat types during the breeding season that special management considerations such as those provided in these guidelines need to be considered. In Texas, vireo habitat is found on rocky limestone soils of the Edwards Plateau, Cross Timbers and Prairies, eastern Trans-Pecos and, to a limited extent, on igneous soils in the Chisos Mountains. Although Blackcapped Vireo habitat throughout Texas is highly variable with regard to plant species, soils, temperature, and rainfall, all habitat types are similar in vegetation structure; i.e. the "overall look" is somewhat similar although the plant species vary.

Vireos require broadleaf shrub vegetation reaching to ground level for nesting cover. They typically nest in shrublands and open woodlands with a distinctive patchy structure. Typical habitat is characterized by shrub vegetation extending from the ground to about 6 feet or more and covering about 30-60% or greater of the total area. In the eastern portion of the vireo's range, the shrub layer is often combined with an open, sparse to moderate tree canopy. Patches of open grass or bare rock separate the clumps of shrubs and trees. In central Texas,

this habitat is often regrowth from disturbances such as clearing, fire, and browsing. In the Edwards Plateau and Cross Timbers Regions, vireo habitat occurs where soils, topography, and land use produce scattered hardwoods with abundant low cover. Common broadleaved plants in vireo habitat in these regions include: Texas (Spanish) oak, Lacey oak, shin oak, Durand (scaleybark) oak, live oak, mountain laurel, evergreen sumac, skunkbush sumac, flameleaf sumac, redbud, Texas persimmon, Mexican buckeye, elbowbush and agarita. Although Ashe juniper is often part of the plant composition in vireo habitat, preferred areas usually have a low density and cover of juniper.

In the western Edwards Plateau and Trans-Pecos Regions, on the western edge of the vireo's range, the birds are often found in canyon bottoms and slopes where sufficient moisture is available to support diverse shrub vegetation. Dominant woody plants in this habitat type include sandpaper oak, Vasey oak, Texas kidneywood, Mexican walnut, Texas persimmon, lotebush, brasil, wafer ash, mountain laurel, cenizo, whitebrush, and guajillo. For all habitat types, the plant composition appears to be less important than the presence of adequate broad-leaved shrubs, foliage to ground level, and mixture of open grassland and woody cover. Deciduous and broad-leaved shrubs and trees throughout the vireo's range are also important in providing habitat for insects on which the vireo feeds.

Life History

Black-capped Vireos arrive in Texas from mid-March to mid-April. Adult males often arrive before females and first-year males to select their territories. Vireos' territories are often clustered in patches of suitable habitat. Although territories range in size from 1 to 16 acres, most territories are 5 to 10 acres. Males sing to attract mates and defend territories. Many males can be heard singing throughout the breeding season, but singing begins to decline by July. The vireo's song is described as hurried and harsh, composed of numerous phrases separated from one another by pauses of 1 to 3 seconds. Nesting begins after the females arrive in late March to early April. Both the male and female select the nest site and build the nest, but the female often completes it. First nests are built in about 6 to 9 days, but subsequent nests can be built in one day. The cup-shaped nest is suspended from its rim in a fork of a branch about 1 to 6 feet above the ground. However, most Black-capped Vireos nest at about "door-knob" height. Nests have been found in a variety of species including shin oak, scaleybark oak, Texas oak, Vasey oak, sumac, Texas persimmon, juniper, Texas redbud, Mexican buckeye and Texas mountain laurel. The vireo usually nests more than once in the same year. A new nest is constructed each time. Three to four eggs are usually laid in the first nesting attempt, but later clutches may contain only 2 to 3 eggs. The first egg is usually laid one day after completion of the nest, with one egg being laid each subsequent day. Incubation takes 14 to 17 days, and is shared by the male and female. Vireo chicks are fed insects by both adults. The young leave the nest 10 to 12 days after hatching. Fledglings are cared for by the female alone, the male alone, or by both adults. Sometimes the parents split the brood and each care for one or more young. Occasionally, males or females will leave the care of the young to their mate, and attempt another nesting effort. Vireos may live for more than five years, and usually return year after year to the same territory, or one nearby. The birds migrate to their wintering grounds on Mexico's western coast beginning in July, and are gone from Texas by mid-September.

Threats and Reasons for Decline

The Black-capped Vireo is vulnerable to changes in the abundance and quality of its habitat. Habitat may become unsuitable for vireos because of natural plant succession, sustained brood parasitism by the Brown-headed Cowbird, or because of human activities. Factors that can

adversely affect vireo habitat include broad-scale or improper brush clearing, fire suppression, over browsing by deer and livestock, and urbanization. Loss of tropical wintering habitat is also a concern, but requires further study. Poorly planned brush management practices on rangeland may remove too much low growing woody cover, especially when large acreages are treated at one time. This eliminates or reduces habitat value for vireos and for other wildlife, such as White-tailed deer, quail, small mammals, and various songbirds. Over browsing of broad-leaved shrubs by goats, deer, and exotic animals reduces the vegetation in the 2- to 4-foot zone, making it unsuitable for vireo nesting. Continued overuse of these preferred browse plants over many years may eventually eliminate them from the plant community, thus permanently altering the habitat.

In the absence of natural processes, active, well-planned land management is often required to maintain good vireo habitat, especially in the eastern portion of its range. Disturbance, particularly fire, plays an important role in maintaining, improving, or creating vireo habitat. The rangelands of central Texas, and the various plant communities these lands support, evolved under the influence of periodic fires. Historically, these natural and manmade fires maintained a matrix of open grassland, shrubland and woodland. Fire stimulated shrubs to sprout multiple stems at the base, thus providing areas of dense foliage at the 2- to 4-foot level, required by vireos. In the past, fire was responsible for maintaining or periodically returning some areas to vireo habitat. Today, prescribed burning, a valuable range and wildlife management tool occurs on many ranches throughout Texas. However, the combination of overgrazing, brush clearing, and lack of fire in the recent past has reduced vireo habitat in many other areas. Natural plant succession is less of a concern in the western portion of its range where suitable habitat persists for long periods.

Human activities have provided favorable habitat for the Brownheaded Cowbird, which parasitizes vireo nests. The cowbird is usually associated with livestock, farms, dairies, and grain fields, where it benefits from waste grain and insects. They may also be attracted to backyard bird feeders, trash dumps, or other urban areas where food and water are available. Cowbirds lay their eggs in other birds' nests, leaving the host bird to raise their young. The female cowbird often removes an egg or a nestling from the host nest before she lays an egg in it. Cowbird chicks hatch earlier than most hosts' young and are thus able to out-compete the smaller vireo nestlings for food and, consequently, the young vireos typically starve. While some birds remove cowbird eggs from their nest, the vireo does not, although it is known to abandon parasitized nests. Thus parasitized nests usually fail to produce vireos. The amount of brood parasitism varies greatly from one population to another throughout the state, ranging from 10 to over 90% of the nests. Brown-headed Cowbirds are also known to remove vireo chicks from active nests. Evidence indicates that sustained parasitism pressure may lead to local extinctions of vireo populations. Direct habitat loss and fragmentation due to urban and suburban development is a major threat in expanding urban areas of Travis, McLennan, Dallas, Bexar, and Kerr counties. Problems associated with suburban expansion, such as increases in predation by dogs, cats, raccoons, skunks, and jays, have also impacted the vireo.

Recovery Efforts

Research is underway to better understand the distribution, life history, habitat requirements, and land management practices affecting the Blackcapped Vireo. Population surveys during the breeding season are being conducted in known and potential habitat areas. Efforts to provide information and educational opportunities to landowners and the public regarding life history and habitat requirements of the vireo are also a vital part of the recovery effort. Major research

and/or recovery efforts are being conducted on Department of Defense's Fort Hood and Camp Bullis, Travis County and the City of Austin's Balcones Canyonlands Preserve, the U.S. Fish and Wildlife Services' Balcones Canyonlands National Wildlife Refuge, TPWD's Kerr Wildlife Management Area, properties owned and/or managed by The Nature Conservancy of Texas, and in Mexico. Additionally, Environmental Defense through their Safe Harbor Agreement with the U.S. Fish and Wildlife Service is assisting many landowners with thousands of acres to manage and/or create habitat for the benefit of the vireo. Research is ongoing regarding the impact of cowbirds on vireo populations in Texas. Research efforts in Mexico are also underway to gather information concerning life history, habitat requirements, and conservation threats on the wintering range. TPWD biologists are monitoring populations on both state and private lands, and voluntary cowbird trapping is being conducted by more than 400 landowners in counties throughout the range of the vireo. Habitat conservation planning is underway in counties such as Travis and Bexar to allow for urban expansion and development while still conserving endangered species habitat. Intensive monitoring of a large population at the U.S. Army Fort Hood Military Installation is on-going. Finally, efforts to provide information, technical assistance, and incentives for private landowners to incorporate management for Black-capped Vireos into their livestock and wildlife operations are an essential part of the recovery process.

Where To See the Black-capped Vireo

A number of state lands offer opportunities to see and learn more about the Black-capped Vireo. These include Colorado Bend State Park (SP), Devils River State Natural Area (SNA), Kerr Wildlife Management Area, Kickapoo Cavern SP, Lost Maples SNA, and Hill Country SNA. Also, the Balcones Canyonlands National Wildlife Refuge near Austin offers additional opportunities to see Black-capped Vireos. Because the Black-capped Vireo is an endangered species, birders and other observers should carefully follow certain viewing ethics. Observers should be careful not to flush birds from the nest or disturb nests or young. Black-capped Vireos should be viewed only from a distance with binoculars. Do not use recorded calls of the Black-capped Vireo or the Screech Owl to attract birds, and be careful that your presence does not unduly disturb or stress the birds.

How You Can Help

You can help by learning more about the habitat requirements of the Black-capped Vireo and incorporating management practices which create or maintain habitat for these birds. You can also encourage and support private landowners who are managing their land to protect and provide habitat for endangered species. The Black-capped Vireo is a beautiful songbird and is much sought after among people who enjoy birdwatching and nature study. Possibilities exist for landowners to take advantage of the growing demand for natural history tours and vacations. Landowners interested in more information concerning nature-based tourism opportunities should contact the Wildlife Diversity Branch, Texas Parks and Wildlife Department, Austin (800) 792-1112; Environmental Defense, Austin (512) 478-5161; the Nature Conservancy, San Antonio (210) 224-8774. You can also be involved with the conservation of Texas' nongame wildlife resources by supporting the Special Nongame and Endangered Species Conservation Fund. Special nongame stamps and decals are available at Texas Parks and Wildlife Department (TPWD) field offices, most state parks, and the License Branch of TPWD headquarters in Austin. Part of the proceeds from the sale of these items is used to conserve habitat and provide information to the public concerning endangered species. Conservation organizations in Texas also welcome your participation and support.

For More Information Contact

Texas Parks and Wildlife Department

Wildlife Diversity Branch
4200 Smith School Road
Austin, Texas 78744
(512) 912-7011 or (800) 792-1112

or

U.S. Fish and Wildlife Service
Ecological Services Field Office
10711 Burnet Road, Suite 200
Austin, Texas 78758
(512) 490-0057

Management guidelines are available from the Texas Parks and Wildlife Department and U.S. Fish and Wildlife Service for landowners and managers wishing to know more about rangeland management practices which improve habitat for the Black-capped Vireo.

References

- Armstrong, W.E., M.W. Lockwood, and D.K. Stuart. 1992. *Performance report: Black-capped vireo management on Texas Parks and Wildlife Department lands*. Federal Aid Project No. E-1-4, Job No. 3.2.
- Armstrong, W.E., C. Travis, and B.G. Alexander. 1989. *Final report: Black-capped vireo management*. Federal Aid Project No. W-103-R-19, Job No. 60.
- Farquhar, C.C. and J. P. Maresh. 1998. *Population biology and habitat characterization of black-capped vireos at Dolan Falls Ranch Preserve, Val Verde County, Texas. Year two final report*. Endangered Resources Branch, Texas Parks and Wildlife Department. Austin, Texas.
- Graber, J.W. 1961. *Distribution, habitat requirements, and life history of the black-capped vireo*. *Ecol. Mon.* 31:313-336.
- Grzybowski, J.A., R.B. Clapp, and J.T. Marshall, Jr. 1986. *History and current population status of the Black-capped vireo in Oklahoma*. *American Birds* 40:1151-1161.
- Grzybowski, J.A., D.J. Tazik, and G.D. Schnell. 1994. *Regional analysis of blackcapped vireo breeding habitats*. *Condor* 96:512-544.
- Grzybowski, J.A. 1995. "Black-capped vireo (*Vireo atricapillus*).” *The birds of North America*, No. 181. The Academy of Natural Sciences, Philadelphia, and The American Ornithologist Union, Washington D.C.
- Oberholser, H.C. 1974. *The bird life of Texas*. Edgar Kincaid, Ed., University of Texas Press, Austin, Texas. Vol. 2, 1069 pp.
- Robinson, S.K., S.I. Rothstein, M.C. Brittingham, L.J. Petit, and J.A. Grzybowski. 1995. "Ecology and behavior of cowbirds and their impact on host populations" (pp 428-460) in T.E. Martin and D.M. Finch, eds. *Ecology and management of neotropical migratory birds*. Oxford University Press, New York, New York.
- U.S. Fish and Wildlife Service. 1991. *Black-capped vireo recovery plan*. Endangered Species Office, Albuquerque, N.M.
- U.S. Fish and Wildlife Service. 1996. *Black-capped vireo population and habitat viability assessment report*. Compiled and edited by Carol Beardmore, Jeff Hatfield, and Jim Lewis in conjunction with workshop participants. Report of a September 18-21, 1995 workshop arranged by the U.S. fish and Wildlife Service in partial fulfillment of U.S. National Biological Service Grant No. 80333- 1423. Austin, Texas. ix + 57 pp.

Management Guidelines for Black-capped Vireo

The following guidelines address land management practices that can be used to maintain, enhance, or create Black-capped Vireo habitat. They are intended primarily to serve as general guidance for rural landowners and others managing land for livestock and/or wildlife in Texas. The guidelines are based on our current understanding of the biology of this species.

Private landowners have a tremendous opportunity to conserve and manage the fish and wildlife resources of Texas. The objective of these guidelines is to provide landowners with recommendations about how typically-used land management practices could be conducted so that it would be unlikely that Black-capped Vireos would be impacted. The guidelines will be updated periodically to make them more practical and useful to rural landowners. The guidelines are based on the best available information and current understanding about the biology of the vireo, but may be refined as additional biological data are collected. TPWD biologists have prepared these guidelines in consultation with USFWS biologists to assure landowners who carry out land management practices within the guidelines that they would know, with the greatest certainty possible, that they would not be in violation of the Endangered Species Act.

This document also provides information on land management practices that are appropriate for protection and/or enhancement of habitat.

The categories were chosen to represent commonly encountered vegetation types and to address common questions regarding the effect of management practices on Black-capped Vireos. In addition, suggestions are offered that promote conservation of soil, water, plant, and wildlife resources.

Prescribed Burning

Fire is a natural component of Texas rangelands, and prescribed burning has many range and wildlife management benefits. These include improved forage quality and availability for livestock and deer, and maintenance of desirable plant composition and structure. Prescribed burning in some portions of the vireos range can be an excellent tool used to maintain or create the desired vegetation structure for vireo nesting; i.e. a mosaic of shrubs and open grassland with abundant woody foliage below 10 feet. If planning these activities in Bandera, Kerr, Kimble, Real, and Uvalde counties, landowners should avoid impacts to Tobusch fishhook cactus (*Ancistrocactus tobuschii*), a federally listed endangered plant, which occurs on similar soils as the vireo. Cool season burns that are patchy and low intensity, conducted prior to March 15, are often recommended to control small juniper, thus maintaining the relatively open shrublands preferred by vireos. Care should be taken to burn under appropriate humidity and wind conditions to maintain the proper black-capped vireo vegetation profile. Prescribed burns conducted during late spring and early fall, under hotter conditions, can be used to set back plant succession to create vireo habitat; however, warm season burns should be done only in areas that do not currently support Black-capped Vireos. On grazed rangeland, prescribed burns should be coordinated with livestock rotation to allow for needed deferments. It is best to avoid burning relatively small areas within large pastures to prevent heavy grazing pressure by livestock and/or deer on burned areas.

Desirable burn intervals for cool season burns vary throughout the state, depending on rainfall and vegetation type. Field experience shows that, for much of the Hill Country, a burning interval of 5 to 7 years is considered desirable to keep Ashe juniper (cedar) invasion in check and to allow regrowth of broad-leaved shrubs. Maintaining open grassland areas between

clumps of shrubs is important for good vireo habitat.

Research is needed to better understand the use of prescribed burning to maintain and create vireo habitat, and to develop guidelines on desirable burn intervals throughout the vireo's range in Texas, especially in the western Edwards Plateau and eastern Trans-Pecos. Assistance from people experienced with the use of prescribed burning is highly recommended.

Landowners are encouraged to have a complete written prescribed burn plan addressing the objectives of the burn, required weather conditions, grazing deferments, fireguard preparations, personnel and equipment needed for nest concealment. Livestock and deer management, which allows woody plants such as live oak, shin oak, sumac, Texas persimmon, elbowbush, redbud, and hackberry to make dense growth from zero to at least 8 feet, is needed. On ranches throughout Texas, moderate stocking, rotation of livestock, controlling deer and exotic ungulate numbers and proper use of desirable browse plants will benefit deer and livestock as well as Black-capped Vireos.

To provide adequate nesting cover for vireos, woody plants should receive only limited browsing during the spring and summer. If animals (livestock, deer, and exotics) are wellmanaged and kept within recommended stocking rates, this can be achieved. Experience has shown that, in general, ranges stocked with cattle and deer tend to maintain better vireo nesting cover than ranges stocked with goats and exotic animals.

Limit browsing pressure, especially during the growing season, to no more than 50% of the total annual growth (current year twigs and leaves) within reach of animals on any given plant. This will maintain plants that are already vigorous and allow for improvement of those with less than ideal structure. As a rule of thumb, if you can "see through" a needed, a detailed map showing how the burn will be conducted, and notification and safety procedures.

Landowners are advised to contact local representatives of the Texas Parks and Wildlife Department, USDA Natural Resources Conservation Service, or Texas Cooperative Extension for help in developing and implementing a prescribed burning program designed specifically for your property and management objectives.

Selective Brush Management

In some portions of the vireos range, particularly the central and eastern segment, increases in juniper (cedar) and other woody species can cause the vegetation to grow out of the patchy, low shrub cover that provides suitable habitat. In these communities, good nesting habitat generally has between 30-60% shrub canopy. Selective brush removal with herbicides or mechanical means during the non-breeding season (September-February) can be used to keep the habitat favorable for vireo nesting.

For example, the selective removal of juniper, mesquite, or pricklypear (less desirable to the vireo and to the rancher) serves to maintain the proper shrub canopy and encourages growth of associated broad-leaved shrubs. Selective brush removal should strive to maintain the desired low shrubby structure. Radical changes in shrub canopy from one year to the next over large areas should be avoided, since this may alter vireo habitat too drastically within a short time-frame. However, moderate thinning of dense (>60%) shin oak so that the low canopy is maintained at 30-60% shrub canopy can enhance habitat. Western Edwards Plateau rangelands comprised primarily of mesquite, often referred to as mesquite flats, are not considered Black-capped Vireo habitat; therefore, mesquite control in these areas will not affect

vireos. When using herbicides, careful attention to the kinds, amounts, timing, and application technique will achieve the best control of target species at minimum cost. Precise application also reduces the risk of environmental contamination and offsite effects. It is best to choose highly selective individual plant treatment methods, whenever practical, to avoid damage to desirable shrubs such as live oak, shin oak, Texas oak, hackberry, Texas persimmon, sumac, redbud, and elm. Herbicides should always be used in strict accordance with label directions, including those for proper storage and disposal of containers and rinse water. Herbicide applications should not occur during the breeding season, except for basal applications or individual plant treatment of prickly pear pads.

Carefully planned mechanical methods of brush management such as chaining, roller chopping, shredding, hand cutting, hydraulic shearing, grubbing, and tree dozing can be used to achieve desirable shrub composition and to stimulate basal sprouting of key woody species in order to maintain, enhance, or create vireo habitat. If planning these activities in Bandera, Kerr, Kimble, Real, and Uvalde counties landowners should avoid impacts to Tobusch fishhook cactus (*Ancistrocactus tobuschii*), a federally listed endangered plant, which occurs on similar soils as the vireo. As with other habitat manipulation procedures, mechanical methods should only be used during the non-breeding season (September-February) and done in such a way as to maintain the proper black-capped vireo vegetation profile. Remember that good grazing management and moderate stocking rates can reduce woody plant invasion and therefore the need for expensive brush control practices.

Finally, although brush management practices can be used to change the structure and composition of vegetation so that vireos may occupy the habitat, landowners should seek technical assistance when planning brush management practices in habitat that is known to be occupied by Black-capped Vireos. Since brush management activities can affect habitat for the Golden-cheeked Warbler as well as the Black-capped Vireo, landowners are encouraged to learn about the habitat requirements of both endangered songbirds (see TPWD leaflet on the Golden-cheeked Warbler).

Grazing and Browsing Management

Excessive browsing by goats, exotic animals, and white-tailed deer destroys the thick woody growth browse plant at “door knob” to “eye level”, then too much stem and leaf growth has been removed. Installation of structures needed to facilitate good grazing management; i.e., fencing, pipelines, water troughs, water tanks, and ponds, need to avoid removing vireo habitat, should include only enough space to allow for proper operation and maintenance, and need to conduct activities during the non-nesting period (September-February).

Careful management of woody plants will not only provide for the habitat needs of Black-capped Vireos, but will also create high quality habitat for deer and other wildlife as well as livestock. Technical assistance in identifying browse plants and determining proper use is available from the Texas Parks and Wildlife Department and USDA Natural Resources Conservation Service.

Reducing Impacts From Cowbirds

Brood parasitism by Brown-headed Cowbirds poses a serious threat to successful reproduction in some populations of Black-capped Vireos. Research is currently underway to better understand the impacts of cowbirds on vireos. Because livestock attract cowbirds, management to reduce cowbird impacts is important on grazed land.

Because cowbirds are attracted to easily available sources of food, avoid spilling or scattering

grain. Supplemental feeding areas should be moved frequently and kept free from accumulations of waste grain. This would help to prevent sparsely vegetated areas of compacted soils, which also tend to attract cowbirds.

Because cowbirds can be attracted by the presence of livestock, grazing management can be used to remove grazing animals from areas where vireos nest. For example, livestock can be rotated away from prime nesting habitat during the breeding season. Another option is to graze stocker cattle during the fall and winter, resting pastures during the spring/summer nesting season. Resting pastures periodically improves range condition and may also help reduce nest parasitism.

Finally, trapping and/or shooting cowbirds can be very effective in reducing vireo brood parasitism, since a single female cowbird can parasitize hosts over a sizeable area (4-5 acres, or more). Mounted mobile traps, placed near watering sites as livestock are rotated through pastures, have been used successfully to reduce cowbird numbers. Properly placed stationary traps have also proven effective in reducing cowbird numbers and parasitism in a local area. Shooting cowbirds at places where they congregate is another option, although this method is often not selective for the cowbirds responsible for the parasitism. Shooting female cowbirds within Black-capped Vireo nesting habitat for as little as one hour a week can reduce parasitism.

Persons trapping cowbirds need to be certified for the handling of non-target birds under the general trapping permit held by TPWD. Preventing mortality of non-target birds is very important, so traps must be carefully monitored and checked frequently.

Contact Texas Parks and Wildlife Department for information and assistance in implementing a cowbird control program.

Habitat Restoration

For landowners in central Texas wishing to restore or create habitat for the Black-capped Vireo in areas currently unoccupied by vireos, the following suggestions are offered.

One type of restorable habitat is an open shrubland capable of growing a diversity of woody plants, where much of the low-growing cover has been removed through overbrowsing by livestock or deer. Controlling browsing pressure by reducing animal numbers and providing pasture rest will allow the natural reestablishment of low-growing shrub cover needed by vireos. Prescribed burning and or mechanical methods described under the Selective Brush Management section may be needed to jump start the resprouting and root sprouting of trees and shrubs.

Habitat restoration may also be possible in areas where the shrub layer has become too tall or dense to provide good vireo habitat. In these areas, well-planned use of controlled fire or other brush management techniques listed above can reduce overall shrub height, stimulate basal sprouting of shrubs, and reduce shrub density to produce more favorable habitat for vireos. The goal is to maintain the critical low growing canopy cover of 30-60%.

Also, in areas where the brush has become too dense, selective thinning conducted during the nonnesting period (September through February) could be done to produce a more open habitat. Carefully planned brush management could be used to encourage regeneration and lateral branching of desirable shrubs by allowing sunlight to reach the ground. The idea is to restore areas to relatively open, low-growing shrub/grassland vegetation that may provide

habitat preferred by vireos. If planning any of these activities in Bandera, Kerr, Kimble, Real, and Uvalde counties landowners should avoid impacts to Tobusch fishhook cactus (*Ancistrocactus tobuschii*), a federally listed endangered plant, which occurs on similar soils as the vireo.

Currently, there is no strong evidence to suggest that habitat manipulation will be necessary on many parts of the drier western and southwestern Texas range (western Edwards Plateau and eastern Trans-Pecos) as mature vegetation communities in these areas are used successfully by vireos. Unless browsing pressure or other catastrophic disturbances have eliminated desirable shrub land in these areas, the only requirement needed is time. Fire is of limited use in lower rainfall areas devoid of fine fuels and the plant density required for cost-effective prescribed burns.

There are a number of agencies and organizations conducting management activities benefiting the vireo that can provide useful information and/or assistance to landowners. These include Texas Parks and Wildlife Department, USFWS, The Nature Conservancy, USDA Natural Resources Conservation Service, and Environmental Defense.

Summary

In the Edwards Plateau and other parts of the range supporting woodland or savanna, periodic prescribed burning and selective brush management are very effective in maintaining and creating Black-capped Vireo habitat. In all parts of the range, control of deer and exotic wildlife numbers, and good grazing management practices, including proper stocking and rotational grazing, are management options that can be used to maintain and enhance habitat for Black-capped Vireos. These same management tools will also maintain diverse and productive rangelands. In addition to providing food, fiber, and support for rural landowners, wellmanaged rangelands provide habitat for a wide variety of wildlife, and benefits such as clean water, natural diversity, and recreational opportunities for all Texans.

Technical assistance in range and wildlife management, including grazing management, determination of proper stocking rates, prescribed burning, brush management, and management for endangered species, is available to landowners and managers by contacting the Texas Parks and Wildlife Department, USDA Natural Resources Conservation Service, or Texas Cooperative Extension. Further guidance and specific questions concerning Black-capped Vireo research, endangered species management and recovery, and the Endangered Species Act, should be directed to the U.S. Fish and Wildlife Service or Texas Parks and Wildlife Department. If, after reading this leaflet, you are still unsure whether or not your management plans will adversely affect the Vireo or its habitat, please contact the U.S. Fish and Wildlife Service for assistance.

Appendix U

FORMS

Forms contained in this appendix include:

PWD 153-7100-10/03: Landowner Request for Technical Assistance. Landowners desiring technical assistance from Texas Parks and Wildlife Department should fill in this form and mail it to their local biologist.

PWD 885-W7000: 1-d-1 Open Space Agricultural Valuation Wildlife Management Plan. Landowners wishing to manage their property for wildlife as their agricultural practice must fill in and attach this form to their **1-d-1 Open Space Agricultural Valuation Application** form that is available from the county Central Appraisal District. *Do not return this form to Texas Parks and Wildlife Department.*

PWD 885-W7000: 1-d-1 Open Space Agricultural Valuation Annual Reporting Form. This form is not automatically required. For counties requesting a landowner report on wildlife management activities, this form will be provided to the landowner by the Chief Appraiser. *Do not return this form to Texas Parks and Wildlife Department.*





LANDOWNER REQUEST FOR TECHNICAL GUIDANCE



1. I hereby request technical assistance of the Texas Parks and Wildlife Department, Wildlife Division field staff, in my efforts to enhance habitat and manage wildlife populations on lands under my control.
2. Permission is granted to the Texas Parks and Wildlife Department, Wildlife Division field staff, to enter upon these lands and conduct, at a mutually agreeable time, wildlife and habitat inventories which may include the use of ground vehicles, aircraft, or nighttime spotlight counts to gather data necessary for the development of management recommendations.

Section 12.0251 of the Parks and Wildlife Code provides that information collected in response to a landowner request for technical guidance on private land relating to the specific location, species identification or quantity of any animal or plant life is confidential and may not be disclosed. The Department may release game census, harvest, habitat or program information if the information is summarized in a manner that prevents the identification of an individual or specific parcel of land and the landowner.

3. I understand that recommendations will be provided to me in the form of oral and/or written guidelines, which are non-binding and voluntary on my part. By my signature, I certify that I am the owner of the below-described property or that I have been specifically authorized by the landowner to act as their agent in this matter.

Signed: _____
 Landowner or Authorized Agent Date

Name of Property: _____

County: _____ Acres: _____

City, State, Zip: _____

Phone Number(s):

Home: _____ Office: _____ Other _____

Title V Compliance: The Texas Parks and Wildlife Department provides this service to land managers without discrimination in respect to race, color, national origin, age or handicap.

Texas Parks and Wildlife Department maintains the information collected through this form. With few exceptions, you are entitled to be informed about the information we collect. Under Sections 552.021 and 553.023 of the Texas Government Code, you are also entitled to receive and review the information. Under Section 559.004, you are also entitled to have this information corrected. For assistance call 512-389-4959.



1-D-1 Open Space Agricultural Valuation Wildlife Management Plan for the Year (s) _____

Submit this plan to your County Chief Appraiser, not to Texas Parks and Wildlife Department

Part I. Owner Information

Account Number: _____

Owner's Name: _____

Current mailing address: _____

City, town, post office, state and zip code: _____

Phone number: _____

Tract Name: _____ Majority County: _____

Additional Counties (if any): _____

Part II. Property Description

Legal Description of Property: _____

Location of Property (distance and direction from nearest town; specify highway/road numbers):

Is Acreage under high fence: Yes No Partial: (Describe) _____

Total Acreage: _____ Ecoregion _____
(refer to Comprehensive Wildlife Management Planning Guidelines)

Habitat Types and Amounts of Acres:

Cropland _____ Bottomland/Riparian _____ wetlands _____
Native

Non-native Pasture _____ Pasture/Grassland _____ timberlands _____

Native Range/Brush _____ Other (describe) _____

III. Species targeted for management. (List all that apply. Attach additional page(s) if needed)

Deer turkey quail songbirds waterfowl doves bats

Neotropical songbirds (List) _____

Reptiles (list) _____ Amphibians (list) _____

Small mammals (list) _____ Insects (list) _____

Identified species of concern (List) _____

Other (List) _____

Part IV. Management Plan Goals and Objectives

Describe the wildlife management **goals** (what you want the property to look like, or want to be able to do with it) and **objectives** (how you intend to achieve these goals) for this piece of property. You may use an additional page if needed. (Note: This space will expand as you type.)

Part V. Qualifying Wildlife Management Activities

Check the wildlife management practices to be implemented on the property during the coming year that will support and achieve your management goals. A minimum of three practices is required.

<input type="checkbox"/> Habitat control	<input type="checkbox"/> Provide supplemental supplies of water
<input type="checkbox"/> Erosion control	<input type="checkbox"/> Provide supplemental supplies of food
<input type="checkbox"/> Predator control	<input type="checkbox"/> Provide shelters
<input type="checkbox"/> Making census counts to determine population.	

Part VI. White tail Deer and Mule Deer Population Management

Is hunting to be a part of this wildlife management plan? Yes No

If YES, type of hunting: Lease hunting Family/guests only Both

List deer harvest for past three seasons:

Year: _____	Bucks: _____	Does: _____
Year: _____	Bucks: _____	Does: _____
Year: _____	Bucks: _____	Does: _____

Population Management Goals:

Target Density for Pre-season Deer Population (fall density) _____

Target Sex Ratio (does/buck): _____

Target Production (fawns/doe): _____

Other (may be age, weight, antler measurements, browse conditions, etc.) _____

Deer Harvest Strategy (numbers, types of deer to be harvested to achieve goals): _____

Part VII. Wildlife Management Association Membership

Are you a member of a wildlife management association (co-op)? Yes No

Are you a member of a wildlife property association? Yes No

Name of wildlife property co-op/association, if YES is checked. _____

Part VIII. Wildlife Management Activities

Check the activities you intend to implement during the year to support each of the wildlife management activities listed in Part V.

<p>1. HABITAT CONTROL</p> <p><input type="checkbox"/> <i>Grazing management.</i> Check grazing system being utilized.</p> <p><input type="checkbox"/> 1 herd/3pasture <input type="checkbox"/> 1 herd/4 pasture <input type="checkbox"/> 1 herd/multiple pasture</p> <p><input type="checkbox"/> High intensity/low frequency (HILF) <input type="checkbox"/> Short duration system</p> <p><input type="checkbox"/> Other type of grazing system (describe) _____</p> <p><i>Additional Information:</i> _____</p>
<p><input type="checkbox"/> <i>Prescribed Burning</i></p> <p>Acres to be burned: _____ Planned burn date: _____</p> <p><i>Additional Information:</i> _____</p>
<p><input type="checkbox"/> <i>Range Enhancement (Range Reseeding)</i></p> <p>Acres to be seeded: _____ Date to be seeded: _____</p> <p>Seeding Method: <input type="checkbox"/> Broadcast <input type="checkbox"/> Drilled <input type="checkbox"/> Native Hay</p> <p>Seeding mixture to be used:</p> <p>Fertilized: <input type="checkbox"/> Yes <input type="checkbox"/> No</p> <p>Weed control needed for establishment? <input type="checkbox"/> Yes <input type="checkbox"/> No</p> <p><i>Additional Information:</i> _____</p>
<p><input type="checkbox"/> <i>Brush Management.</i> Acres to be treated: _____ Check method of brush management:</p> <p><input type="checkbox"/> Mechanical</p> <p><input type="checkbox"/> grubber <input type="checkbox"/> chain <input type="checkbox"/> roller chopper/aerator <input type="checkbox"/> rhome disc</p> <p><input type="checkbox"/> brush hog (shredder) <input type="checkbox"/> dozer <input type="checkbox"/> hand-cutting (chainsaw)</p> <p><input type="checkbox"/> hydraulic shears <input type="checkbox"/> other (describe): _____</p> <p><input type="checkbox"/> Chemical Kind: _____ Rate: _____</p> <p><input type="checkbox"/> Brush management design:</p> <p><input type="checkbox"/> block <input type="checkbox"/> mosaic <input type="checkbox"/> strips: width: _____ Length: _____</p> <p><i>Additional Information:</i> _____</p>
<p><input type="checkbox"/> <i>Fence Modification</i></p> <p>Target species: <input type="checkbox"/> pronghorn antelope <input type="checkbox"/> bighorn sheep</p> <p>Technique: <input type="checkbox"/> fold up bottom of net-wire Gap width: _____</p> <p><input type="checkbox"/> replace sections of net-wire with barbed wire. Gap width: _____</p> <p>Miles of fencing that will be modified: _____</p> <p><input type="checkbox"/> replace entire net-wire fence with barbed wire. Miles replaced: _____</p> <p><i>Additional Information:</i> _____</p>

Riparian management and enhancement

Fencing of riparian area

Complete fencing Partial fencing

Deferment from livestock grazing

Complete deferment partial deferment Season deferred : _____

Establish vegetation

Trees (list species) _____

Shrubs (list species) _____

Herbaceous species (list) _____

Additional Information: _____

Wetland enhancement

Provide seasonal water Provide permanent water Moist soil management

Other (describe) _____

Additional Information: _____

Habitat Protection for species of concern

Fencing Firebreaks Prescribed burning Control of nest parasites

Habitat manipulation (thinning, etc.) Native/exotic ungulate control

Other (describe) _____

Additional Information: _____

Prescribed Control of Native, Exotic and Feral Species

Prescribed control of vegetation Prescribed control of animal species

Species being controlled: _____

Method of control: _____

Additional Information: _____

Wildlife Restoration

Habitat restoration Wildlife restoration

Target species: _____

Method of restoration: _____

Additional Information: _____

2. EROSION CONTROL

Pond construction and repair

Surface area (acres): _____ Number of cubic yards of soil displaced: _____

Length of dam (feet): _____ Planned date of construction: _____

Additional Information: _____

Gully shaping

Total acres to be treated: _____ Acres treated annually: _____

Seeding mix used for reestablishment of vegetation: _____

Planned date of construction: _____

Additional Information: _____

Streamside, pond, and wetland revegetation. Techniques used:

Native hay bales Fencing Filter strips Seeding upland buffer

Rip-rap, etc. stream crossings Other: _____

Planned date of construction: _____

Additional Information: _____

Herbaceous and/or woody plant establishment on critical areas (erodible)

Establish windbreak Establish shrub mottes Improve plant diversity

Improve wildlife habitat Conservation/no-till practices Manage CRP cover

Additional Information: _____

Dike/Levee Construction/Management

Reshaping/repairing erosion damage Revegetating/stabilize levee areas

Install water control structure Fencing

Additional Information: _____

Establish water diversion

Type: Channel Ridge

Slope: level graded Length (feet) _____

Vegetated: No YES

If YES: Native: _____ Crop: _____

Additional Information: _____

3. PREDATOR CONTROL

- Imported red fire ants (verify prior to application that product is labeled for pasture use)
- Control of cowbirds Grackle/starling/house sparrow control
- Method of control: Trapping Shooting Baiting Scare tactics _____
- Coyotes Feral hogs Raccoon Skunk Bobcat Mountain lion
- Rat snakes Feral cats/dogs
- Method of control: Trapping Shooting M-44 (licensed applicators)
- Poison collars (1080 certified, licensed, applicator) Other _____
- Additional Information:* _____

4. SUPPLEMENTAL WATER

- Marsh/Wetland Restoration or Development*
- Greentree reservoirs Shallow roost pond development Seasonally flooded crops
- Artificially created wetlands Marsh restoration/development/protection
- Prairie pothole restoration/development/protection Moist soil management units
- Planned date of construction: _____
- Additional Information:* _____

- Well/trough/windmill overflow/other wildlife watering facilities*
- Drill new well Depth: _____ Gallons per minute: _____
- Windmill Pump Pipeline: Size _____ Length: _____
- Modification(s) of existing water source
- Fencing Overflow Trough modification Pipeline
- Distance between water sources (waterers): _____
- Type of wildlife watering facility
- | | |
|---|--|
| <input type="checkbox"/> PVC pipe facility # _____ | <input type="checkbox"/> Drum with faucet or float # _____ |
| <input type="checkbox"/> Small game guzzler # _____ | <input type="checkbox"/> Windmill supply pipe dripper # _____ |
| <input type="checkbox"/> Plastic container # _____ | <input type="checkbox"/> In-ground bowl trough # _____ |
| <input type="checkbox"/> Big game guzzler # _____ | <input type="checkbox"/> Inverted umbrella guzzler # _____ |
| <input type="checkbox"/> Flying saucer guzzler # _____ | <input type="checkbox"/> Ranch Specialties guzzler # _____ |
| <input type="checkbox"/> Other: _____ | |
- Additional Information:* _____

- Spring development and/or enhancement*
- Fencing Water diversion/pipeline Brush removal Spring clean out
- Other: _____
- Additional Information:* _____

5. PROVIDING SUPPLEMENTAL FOOD

Grazing management Prescribed burning Range enhancement

Food plots Size: _____ Fenced: Yes No

Irrigated: Yes No

Plantings: Cool season annual crops: _____

Warm season annual crops: _____

Annual mix of native plants: _____

perennial mix of native plants: _____

Additional Information: _____

Feeders and mineral supplementation

Purpose: Supplementation Harvesting of wildlife

Targeted wildlife species: _____

Feed type: _____ Mineral type: _____

Feeder type: _____ Number of feeders: _____

Method of mineral dispensing: _____

Number of mineral locations: _____

Year round: Yes No If not, state when: _____

Additional Information: _____

Managing tame pasture, old fields and croplands

Overseeding cool and/or warm season legumes and/or small grains

Periodic disturbance (Discing/Mowing/Shredding) Conservation/no-till

Additional Information: _____

Transition management of tame grass monocultures

Overseed 25% of tame grass pastures with locally adapted legumes

Species planted: Clover Peas Vetch Other: _____

Additional Information: _____

6. PROVIDING SUPPLEMENTAL SHELTER

Nest boxes Target Species: _____

Cavity type. # _____ Bat boxes. # _____ Raptor pole. # _____

Additional Information: _____

Brush piles and slash retention

Type: Slash Brush piles Number per acre: _____

Additional Information: _____

Fence line management Length: _____ Initial establishment: Yes No

Plant type established: Trees Shrubs Forbs Grasses

Additional Information: _____

Hay meadow, pasture and cropland management for wildlife Acres treated: _____

Shelter establishment: Roadside management Terrace/wind breaks Field borders

shelterbelts Conservation Reserve Program lands management

Type of vegetation: Annual Perennial

Species and percent of mixture _____

Deferred mowing Period of deferment: _____

Mowing Acres mowed annually: _____

No till/minimum till

Additional Information: _____

Half-cutting trees or shrubs

Acreage to be treated annually: _____ Number of half-cuts annually: _____

Additional Information: _____

Woody plant/shrub establishment

Pattern: Block Mosaic Strips: Width: _____

Acreage or length established annually: _____ Spacing: _____

Shrub/tree species used: _____

Additional Information: _____

Natural cavity/snag development

Species of snag _____ Size of snags: _____ Number/acre _____

Additional Information: _____

7. CENSUS

Spotlight counts Targeted species: _____
Length of route: _____ Visibility of route _____
Dates (3 required) A. _____ B. _____ C. _____
Additional Information: _____

Standardized incidental observations Targeted species: _____
Observations from: Feeders Food plots Blinds Vehicle Other _____
Dates: _____
Additional Information: _____

Stand counts of deer (5 one hour counts per stand required). Number of stands: _____
Dates: _____
Additional Information: _____

Aerial Counts Species counted: _____
Type of survey: Helicopter Fixed-wing
Percent of area surveyed: Total 50% Other: _____
Additional Information: _____

Track counts: Predators Furbearers Deer Other: _____
Additional Information: _____

Daylight deer herd/wildlife composition counts
Species: Deer Turkey Dove Quail Other _____
Additional Information: _____

Harvest data collection/record keeping: Deer Game birds
 Age Weight Sex Antler data Harvest date
Additional Information: _____

Browse utilization surveys (thirty 12 foot circular plots required)
Additional Information: _____

Census of endangered, threatened, or protected wildlife. Species: _____
Method and dates: _____
Additional Information: _____

Census and monitoring of nongame wildlife species. Species: _____
 Method and dates: _____
Additional Information: _____

Miscellaneous Counts: Species being counted: _____

Remote detection (i.e. cameras) Hahn (walking) line Roost counts

Booming ground counts Time/area counts Songbird transects and counts

Quail call and covey counts Point counts Small mammal traps

Drift fences and pitfall traps Bat departures Dove call counts

Chachalaca counts Turkey hen/poult counts Waterfowl/water bird counts

Alligator nest/census counts Other: _____

Additional Information: _____

IX. Additional Supporting Information. (Optional)

Attach any other supporting information, such as maps or photographs that you believe to be relevant to this wildlife management plan.

I certify that the above information provided by me in this application is to the best of my knowledge and belief, true and complete.

 Landowner Signature

 Date

This area for use only if the wildlife management plan was prepared for the above landowner for a fee by a wildlife professional or consultant. *

Signature of person preparing wildlife management plan.	Date
Company	Phone Number
*Signature by TPWD not required for this plan to be lid.	

Texas Parks and Wildlife does not maintain the information collected through this form. This completed form is only provided to the County Tax Appraiser. Please inquire with your County Central Appraisal District on any local laws concerning any information collected through this form.



1-D-1 Open Space Agricultural Valuation Wildlife Management Annual Report for the Year(s) _____

Submit this plan to your County Tax Appraiser, not to Texas Parks and Wildlife

Part I. Owner Information

Account Number: _____

Owner's Name: _____
Current mailing address: _____
City, town, post office, state and zip code: _____
Phone number: _____
Tract Name: _____ Majority County: _____
Additional Counties (if any): _____

Part II. Qualifying Wildlife Management Activities

Check the wildlife management practices implemented on the property during the year being reported. A minimum of three practices is required.

- Habitat control
- Erosion control
- Predator control
- Making census counts to determine population.
- Provide supplemental supplies of water
- Provide supplemental supplies of food
- Provide shelters

Part III. Wildlife Management Association Membership

Are you a member of a wildlife property association? Yes No

Name of wildlife property co-op/association, if YES is checked. _____

Part IV. Wildlife Management Activities

Check the activities you have implemented during the year to support each of the wildlife management activities listed in Part II.

1. HABITAT CONTROL

- Grazing management.* Check grazing system being utilized.
- 1 herd/3pasture 1 herd/4 pasture 1 herd/multiple pasture
- High intensity/low frequency (HILF) Short duration system
- Other type of grazing system (describe) _____

Additional Information: _____

- Prescribed Burning*

Acres to be burned: _____ Planned burn date: _____

Additional Information: _____

- Range Enhancement (Range Reseeding)*

Acres to be seeded: _____ Date to be seeded: _____

Seeding Method: Broadcast Drilled Native Hay

Seeding mixture to be used:

Fertilized: Yes No

Weed control needed for establishment? Yes No

Additional Information: _____

- Brush Management.* Acres to be treated: _____ Check method of brush management:

Mechanical

grubber chain roller chopper/aerator rhome disc

brush hog (shredder) dozer hand-cutting (chainsaw)

hydraulic shears other (describe): _____

Chemical Kind: _____ Rate: _____

Brush management design:

block mosaic strips: width: _____ Length: _____

Additional Information: _____

- Fence Modification*

Target species: pronghorn antelope bighorn sheep

Technique: fold up bottom of net-wire Gap width: _____

replace sections of net-wire with barbed wire. Gap width: _____

Miles of fencing that will be modified: _____

replace entire net-wire fence with barbed wire. Miles replaced: _____

Additional Information: _____

Riparian management and enhancement

Fencing of riparian area

Complete fencing Partial fencing

Deferment from livestock grazing

Complete deferment partial deferment Season deferred : _____

Establish vegetation

Trees (list species) _____

Shrubs (list species) _____

Herbaceous species (list) _____

Additional Information: _____

Wetland enhancement

Provide seasonal water Provide permanent water Moist soil management

Other (describe) _____

Additional Information: _____

Habitat Protection for species of concern

Fencing Firebreaks Prescribed burning Control of nest parasites

Habitat manipulation (thinning, etc.) Native/exotic ungulate control

Other (describe) _____

Additional Information: _____

Prescribed Control of Native, Exotic and Feral Species

Prescribed control of vegetation Prescribed control of animal species

Species being controlled: _____

Method of control: _____

Additional Information: _____

Wildlife Restoration

Habitat restoration Wildlife restoration

Target species: _____

Method of restoration: _____

Additional Information: _____

2. EROSION CONTROL

Pond construction and repair

Surface area (acres): _____ Number of cubic yards of soil displaced: _____

Length of dam (feet): _____ Planned date of construction: _____

Additional Information: _____

Gully shaping

Total acres to be treated: _____ Acres treated annually: _____

Seeding mix used for reestablishment of vegetation: _____

Planned date of construction: _____

Additional Information: _____

Streamside, pond, and wetland revegetation. Techniques used:

Native hay bales Fencing Filter strips Seeding upland buffer

Rip-rap, etc. stream crossings Other: _____

Planned date of construction: _____

Additional Information: _____

Herbaceous and/or woody plant establishment on critical areas (erodible)

Establish windbreak Establish shrub mottes Improve plant diversity

Improve wildlife habitat Conservation/no-till practices Manage CRP cover

Additional Information: _____

Dike/Levee Construction/Management

Reshaping/repairing erosion damage Revegetating/stabilize levee areas

Install water control structure Fencing

Additional Information: _____

Establish water diversion

Type: Channel Ridge

Slope: level graded Length (feet) _____

Vegetated: No YES

If YES: Native: _____ Crop: _____

Additional Information: _____

3. PREDATOR CONTROL

Imported red fire ants (verify prior to application that product is labeled for pasture use)

Control of cowbirds Grackle/starling/house sparrow control

Method of control: Trapping Shooting Baiting Scare tactics _____

Coyotes Feral hogs Raccoon Skunk Bobcat Mountain lion

Rat snakes Feral cats/dogs

Method of control: Trapping Shooting M-44 (licensed applicators)

Poison collars (1080 certified, licensed, applicator) Other _____

Additional Information: _____

4. SUPPLEMENTAL WATER

Marsh/Wetland Restoration or Development

Greentree reservoirs Shallow roost pond development Seasonally flooded crops

Artificially created wetlands Marsh restoration/development/protection

Prairie pothole restoration/development/protection Moist soil management units

Planned date of construction: _____

Additional Information: _____

Well/trough/windmill overflow/other wildlife watering facilities

Drill new well Depth: _____ Gallons per minute: _____

Windmill Pump Pipeline: Size _____ Length: _____

Modification(s) of existing water source

Fencing Overflow Trough modification Pipeline

Distance between water sources (waterers): _____

Type of wildlife watering facility

PVC pipe facility # _____ Drum with faucet or float # _____

Small game guzzler # _____ Windmill supply pipe dripper # _____

Plastic container # _____ In-ground bowl trough # _____

Big game guzzler # _____ Inverted umbrella guzzler # _____

Flying saucer guzzler # _____ Ranch Specialties guzzler # _____

Other: _____

Additional Information: _____

Spring development and/or enhancement

Fencing Water diversion/pipeline Brush removal Spring clean out

Other: _____

Additional Information: _____

5. PROVIDING SUPPLEMENTAL FOOD

Grazing management Prescribed burning Range enhancement

Food plots Size: _____ Fenced: Yes No

Irrigated: Yes No

Plantings: Cool season annual crops: _____

Warm season annual crops: _____

Annual mix of native plants: _____

perennial mix of native plants: _____

Additional Information: _____

Feeders and mineral supplementation

Purpose: Supplementation Harvesting of wildlife

Targeted wildlife species: _____

Feed type: _____ Mineral type: _____

Feeder type: _____ Number of feeders: _____

Method of mineral dispensing: _____

Number of mineral locations: _____

Year round: Yes No If not, state when: _____

Additional Information: _____

Managing tame pasture, old fields and croplands

Overseeding cool and/or warm season legumes and/or small grains

Periodic disturbance (Discing/Mowing/Shredding) Conservation/no-till

Additional Information: _____

Transition management of tame grass monocultures

Overseed 25% of tame grass pastures with locally adapted legumes

Species planted: Clover Peas Vetch Other: _____

Additional Information: _____

6. PROVIDING SUPPLEMENTAL SHELTER

Nest boxes Target Species: _____

Cavity type. # _____ Bat boxes. # _____ Raptor pole. # _____

Additional Information: _____

Brush piles and slash retention

Type: Slash Brush piles Number per acre: _____

Additional Information: _____

Fence line management Length: _____ Initial establishment: Yes No

Plant type established: Trees Shrubs Forbs Grasses

Additional Information: _____

Hay meadow, pasture and cropland management for wildlife Acres treated: _____

Shelter establishment: Roadside management Terrace/wind breaks Field borders

shelterbelts Conservation Reserve Program lands management

Type of vegetation: Annual Perennial

Species and percent of mixture _____

Deferred mowing Period of deferment: _____

Mowing Acres mowed annually: _____

No till/minimum till

Additional Information: _____

Half-cutting trees or shrubs

Acreage to be treated annually: _____ Number of half-cuts annually: _____

Additional Information: _____

Woody plant/shrub establishment

Pattern: Block Mosaic Strips: Width: _____

Acreage or length established annually: _____ Spacing: _____

Shrub/tree species used: _____

Additional Information: _____

Natural cavity/snag development

Species of snag _____ Size of snags: _____ Number/acre _____

Additional Information: _____

7. CENSUS

Spotlight counts Targeted species: _____
Length of route: _____ Visibility of route _____
Dates (3 required) A. _____ B. _____ C. _____
Additional Information: _____

Standardized incidental observations Targeted species: _____
Observations from: Feeders Food plots Blinds Vehicle Other _____
Dates: _____
Additional Information: _____

Stand counts of deer (5 one hour counts per stand required). Number of stands: _____
Dates: _____
Additional Information: _____

Aerial Counts Species counted: _____
Type of survey: Helicopter Fixed-wing
Percent of area surveyed: Total 50% Other: _____
Additional Information: _____

Track counts: Predators Furbearers Deer _____
Other: _____
Additional Information: _____

Daylight deer herd/wildlife composition counts
Species: Deer Turkey Dove Quail Other _____
Additional Information: _____

Harvest data collection/record keeping: Deer Game birds
 Age Weight Sex Antler data Harvest date
Additional Information: _____

Browse utilization surveys (thirty 12 foot circular plots required)
Additional Information: _____

Census of endangered, threatened, or protected wildlife. Species: _____
Method and dates: _____
Additional Information: _____

Census and monitoring of nongame wildlife species. Species: _____
Method and dates: _____
Additional Information: _____

Miscellaneous Counts: Species being counted: _____

<input type="checkbox"/> Remote detection (i.e. cameras)	<input type="checkbox"/> Hahn (walking) line	<input type="checkbox"/> Roost counts
<input type="checkbox"/> Booming ground counts	<input type="checkbox"/> Time/area counts	<input type="checkbox"/> Songbird transects and counts
<input type="checkbox"/> Quail call and covey counts	<input type="checkbox"/> Point counts	<input type="checkbox"/> Small mammal traps
<input type="checkbox"/> Drift fences and pitfall traps	<input type="checkbox"/> Bat departures	<input type="checkbox"/> Dove call counts
<input type="checkbox"/> Chachalaca counts	<input type="checkbox"/> Turkey hen/poult counts	<input type="checkbox"/> Waterfowl/water bird counts
<input type="checkbox"/> Alligator nest/census counts	<input type="checkbox"/> Other: _____	

Additional Information: _____

Part V. Attach copies of supporting documentation such as receipts, maps, photos, etc. Use additional pages if necessary.

I certify that the above information provided by me is to the best of my knowledge and belief true and complete.

Signature

Date

Texas Parks and Wildlife does not maintain the information collected through this form. This completed form is only provided to the County Tax Appraiser. Please inquire with your County Central Appraisal District on any local laws concerning any information collected through this form.

APPENDIX V

Wildlife Watering Facilities



By

Jerry Turrentine, NRCS Biologist

USDA – Natural Resources Conservation Service

WILDLIFE WATERING FACILITIES DESIGNS AND DRAWINGS

Designs for wildlife watering facilities can be simple or very complex. A simple facility works well in many situations by more complex facilities are needed in some situations. Each situation needs to be evaluated and the proper facility recommended to the landuser. To assist in making recommendations and designing these facilities and to supplement the standard and specifications, this technical note outlines specific criteria for a number of facilities.

GENERAL GUIDELINES

1. Where livestock or larger wildlife species are present, the facilities should be fenced to provide proper protection. One example is shown in drawing number 16.
2. Plastic and PVC materials can be damaged by rodents and ultraviolet light. As little as possible of this material should be left accessible to rodents or sunlight.
3. In areas with hard winter freezes, some facilities can be damaged by hard freezes. Provisions should be made to drain or shut off water supply during these periods.
4. Proper maintenance of equipment will ensure adequate wildlife water and increase life of facilities. As with all equipment, facilities should be checked on a regular basis.
5. Algae growth can be a problem in many facilities. The less sunlight, the less algae growth problems will be encountered. As much as possible, the facility should be shaded. If algae growth becomes too bad, the facility may have to be drained and cleaned.

NON COST SHARE FACILITIES

A. PVC (over other flexible type) Pipe Facility (Drawing #1)

1. Materials:

- 7 feet of 2 inch or larger PVC pipe
- 1 end plug to fit PVC pipe
- 1 sink trap to fit PVC pipe
- 1 six foot steel T post
- 2 four inch hose clamps.

2. Construction and Installation:

Cut off 1 inch of the open end of sink trap. Glue end plug and sink trap to PVC pipe. To fill, turn upside down and fill through sink trap. After filling, use hose clamps to fasten PVC pipe to T post. If larger PVC pipe is used, it can be necked down to 2 inch sink trap. A 3 inch PVC will hold 1 gallon, and a 4 inch will hold 4 gallons.

B. Drum with facet or Float (Drawing #2 and #3)

1. Materials:

- 1 drum (can use metal or plastic).
- 1 facet or float valve
- 1 stand (metal or wood)
- 18 inches of ¼ inch hose
- 1 metal or concrete trough (Should be at least 6" x 6" x 4" deep)

2. Construction and Installation:

Stand should be constructed so as to hold weight of filled drum. Stand should be leveled when installed. Insure that drum did not contain toxic material or is rusted wither inside or outside. If float valve is used, insure that trough is firmly installed and leveled. Most drums hold about 50 gallons.

B. Small Game Guzzler (Drawing #4)

1. Materials:

3 sheets corrugated galvanized metal (at least 10 feet long)
8 feet minimum of 6 inch PVC (over other flexible) pipe
2 six inch PVC caps or end plugs
11 feet of 4 inch post
11 feet of 2x4 inch lumber
30 one inch sheet metal screws
30 sixteen penny nails

2. Construction and Installation:

Three posts should be cut 2.5 feet in length and 3 posts cut 1.5 feet in length. Set post level in ground at 1 foot depth. The front post should be 6 inches lower than back post. Nail a 2x4 to top of back post and one to top of front post. Attach sheet metal together, making sure it is square, and attach to 2x4's. Cut a slot 1 inch wide, the same length as width of assembled sheet metal, out of PVC. Make sure the slot is centered in PVC. Six inches from each end of PVC, cut a 6 inch by 3 inch wide slot on the opposite side of the long slot. Install end plugs or caps.

Dig out soil at lower end of sheet metal. Install and level PVC in dug out area with sheet metal inserted into 1 inch slot. Metal should extend into PVC at least 2 inches. Put enough soil around PVC to ensure that it is stable.

A 0.3 inch rain will fill the PVC, and PVC will hold 12.5 gallons.

C. Windmill Supply Pie Dripper (Drawing #6)

1. Materials:

3 feet of metal or PVC (over other flexible) pipe (should be ½ inch larger in diameter than water supply pipe)
1 cloth or sponge bushing
1 metal or concrete trough

2. Construction and Installation:

Slip metal or PVC pipe sleeve over water supply line. Wedge cloth or sponge bushing between the two pipes. Make sure water discharge will enter trough. The rate of water flow can be regulated by sliding sleeve up or down water supply pipe. Area of pipe and trough should be protected from livestock.

D. Plastic Container (Drawing #13)

1. Materials:

- 1 plastic or metal container (smallest size should be 5 gallons)
- 1 commercial spring operated chicken watering bowl
- 2 cement blocks or 6 bricks

2. Construction and Installation:

Install watering bowl to bottom of watering container. Set facility on blocks or bricks at a height that allows target wildlife species to utilize. Make sure facility is level.

COST SHAREABLE FACILITIES

A. In Ground Bowl Trough (Drawings #7, #8, #12, #14, and #16) Storage Trough:

1. Trough Material: Concrete will be at least 5 sack cement mix. Concrete will be reinforced using 6" x 6" welded wire. Metal trough using pipe should meet criteria for pipe material listed below under heading "Pipe Material". If the trough is constructed of sheet metal it should be new and at least 12 gauge.
2. Trough Size: Concrete troughs for upland game birds should be at least 1 foot by 4 inches deep at the center (will hold 2 gallons). Concrete troughs for big game should be at least 1.5 foot by 6 inches deep at the center (will hold 6.5 gallons). Metal troughs for upland game birds should be at least 4 inch pipe, 3 feet long (will hold 2 gallons). Metal troughs for big game should be at least 6 inch pipe, 5 feet long (will hold 6.5 gallons).

Pipe and Pipeline:

1. Pipe Material: May use existing pipeline or new pipeline and either used shall be at least ¾ inch diameter and can be galvanized steel, aluminum or plastic complying with the following specifications:

Steel A-120 (galvanized)	ABS D-2282 (SDR-PR)
ABS D-1527 (sch. 40 or 80)	PE D-2104 (Sch. 40)
PE D-2239 (SIRD-PR)	PE D-2737 (PE Tubing-PR)
PE D-3035 (SRD-PR)	PVC D-1785 (Sch. 40, 80, or 120)
PVC D-2241 (SDR-PR)	PVC D-2740 (PVC Tubing – PR)
PE D-2247 (Sch. 40 or 80)	

Additional Requirements:

If a facet is used it shall be new and shall meet or exceed pipe used. After water volume is set the handle should be removed. If a float is used it should be new and of good quality. If a drip emitter is used it should have the capability of being cleaned out.

Metal pipe trough will be anchored by use of concrete or metal legs buried in the ground at least 18 inches.

B. Big Game Guzzler (Drawing #9)

For specifications to big game guzzler, see supplement to standard and specifications for wildlife watering facility.

C. Inverted Umbrella Guzzler (Drawing #10)

This facility is commercially produced. It is available in 2000 to 5000 gallon sizes. The basin diameters are 16 to 32 feet. It takes 8 inches annual rainfall for 2000 to 3000 gallon size and 10 inches for the 5000 gallon size. No float needed if trough and tank set at same level.

D. Flying Saucer Guzzler (Drawing #11)

This facility is commercially produced. It is available in 200 to 2100 gallon sizes. It takes 6 inches annual rainfall for 200 gallon size, 8 inches for 1000 gallon size and 17 inches for 2100 gallon size. No float needed if trough and tank set at same level.

E. Ranch Specialties Wildlife Waterer (Drawing #15)

This facility is commercially produced. It holds 9.5 gallons of water. The float is built into the facility. The facility is 42 inches by 42 inches and 7.5 inches deep with a 3 foot diameter bowl. To be eligible for cost share, the facility must be connected to a permanent water source.

WILDLIFE WATERING FACILITIES

SCALE: 3/8" = 1'

SCALE: 3/4" = 1'

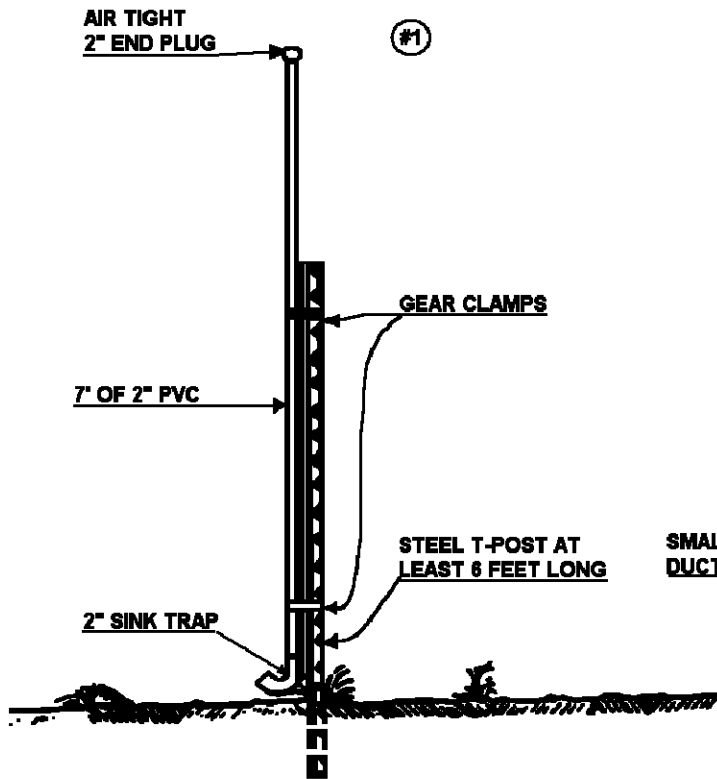

SCALE: 3/4" = 1'

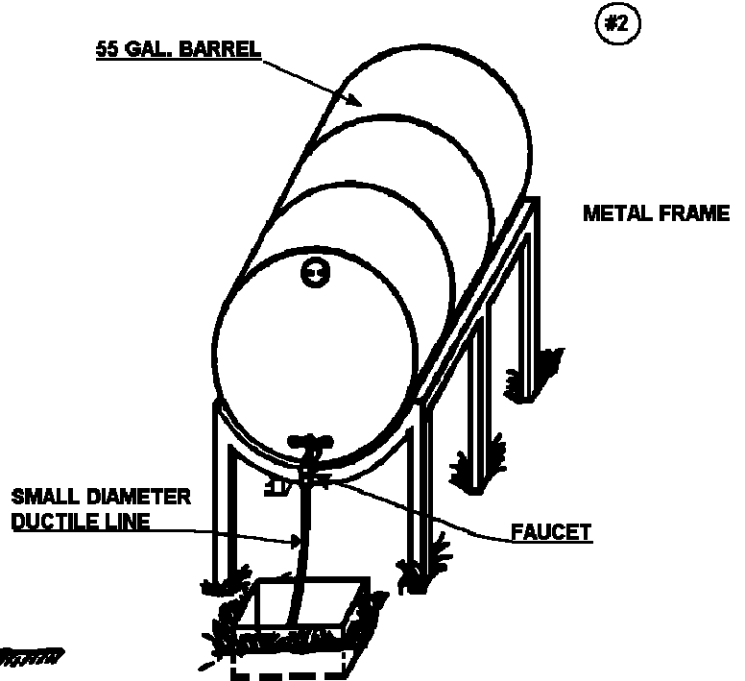

#4

SCALE: 1/4" = 1'

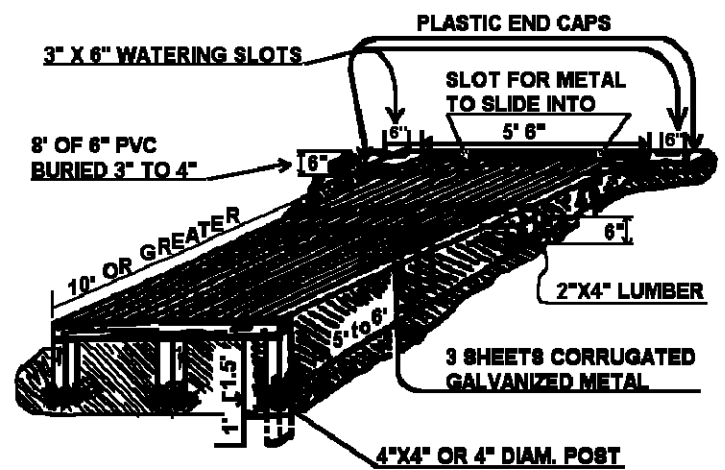
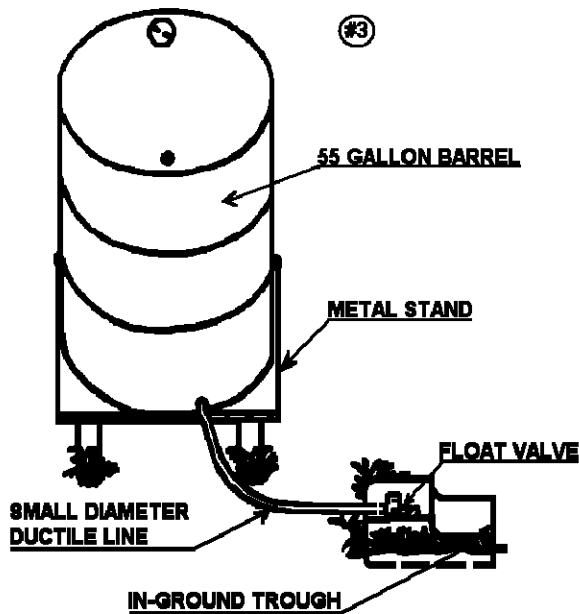

DRAWINGS BY TODD A. MAREK
SEPT. 1991

WILDLIFE WATERING FACILITIES

3 METHODS OF ANCHORING ON-THE-GROUND CATCHMENTS

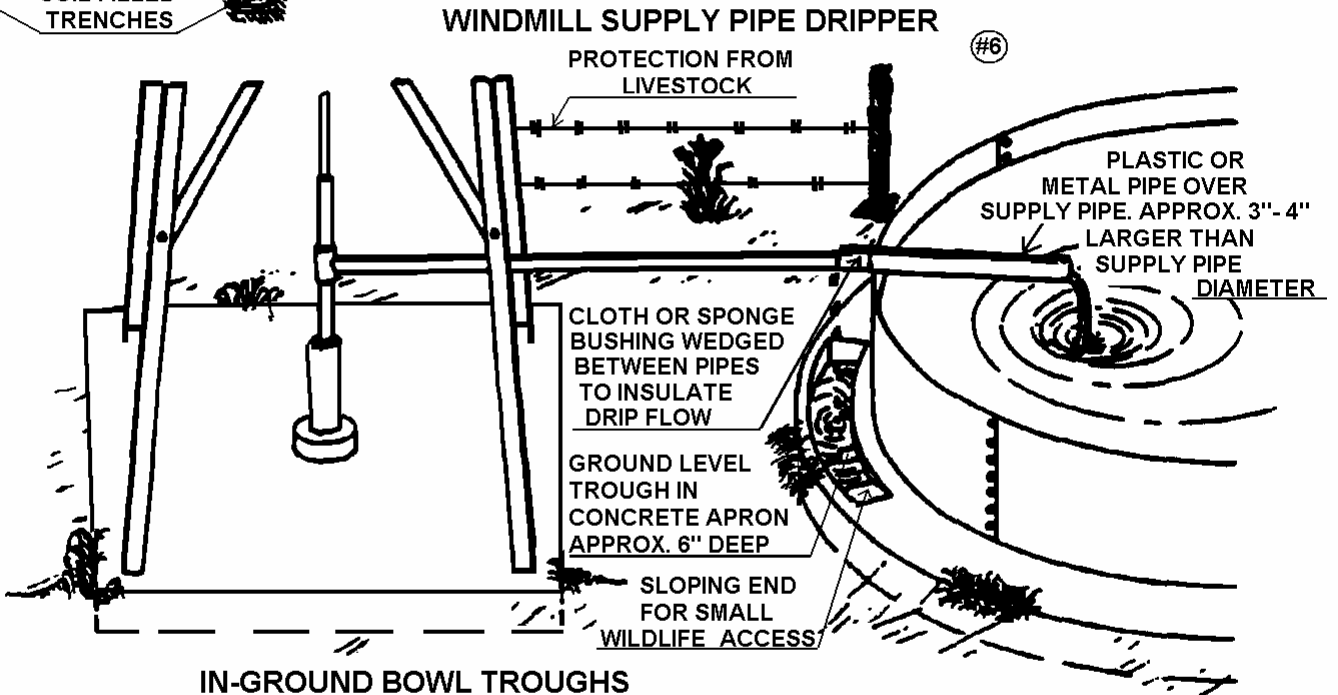
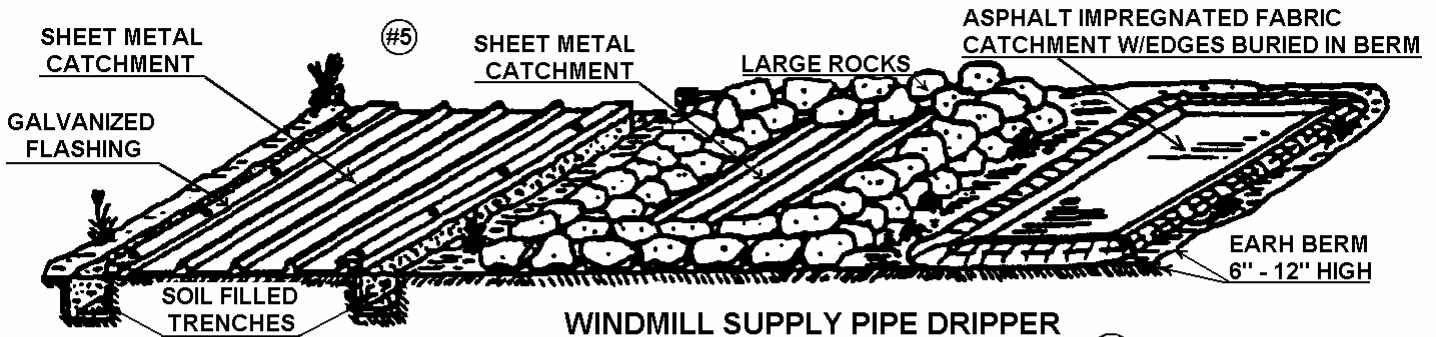

IN-GROUND BOWL TROUGHS

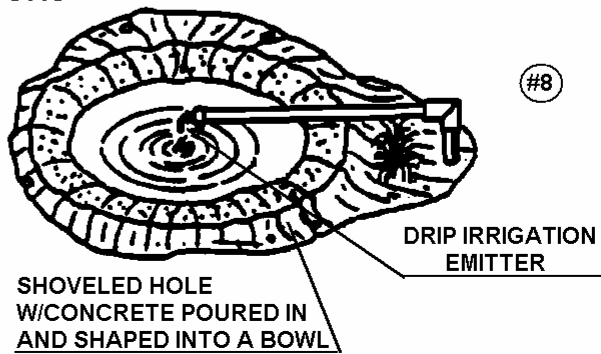
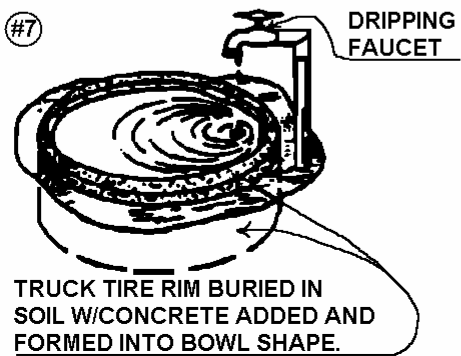

WILDLIFE WATERING FACILITIES

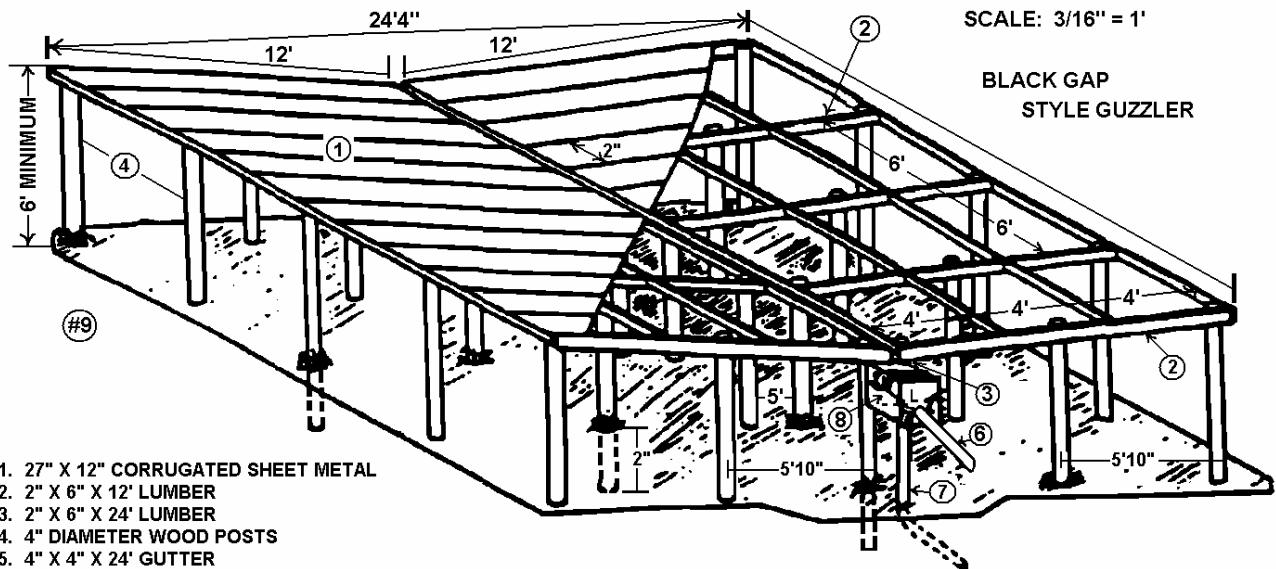

1. 27" X 12" CORRUGATED SHEET METAL
2. 2" X 6" X 12' LUMBER
3. 2" X 6" X 24' LUMBER
4. 4" DIAMETER WOOD POSTS
5. 4" X 4" X 24' GUTTER
6. 3" MINIMUM DOWNSPOUT
7. ALTERNATE DIRECTION FOR DOWNSPOUT
8. 1'6" X 1'6" X 1' SUMP COVERED WITH 1/4" - 1/2" HARDWARE CLOTH

INVERTED UMBRELLA GUZZLER

SCALE: 3/16" = 1'

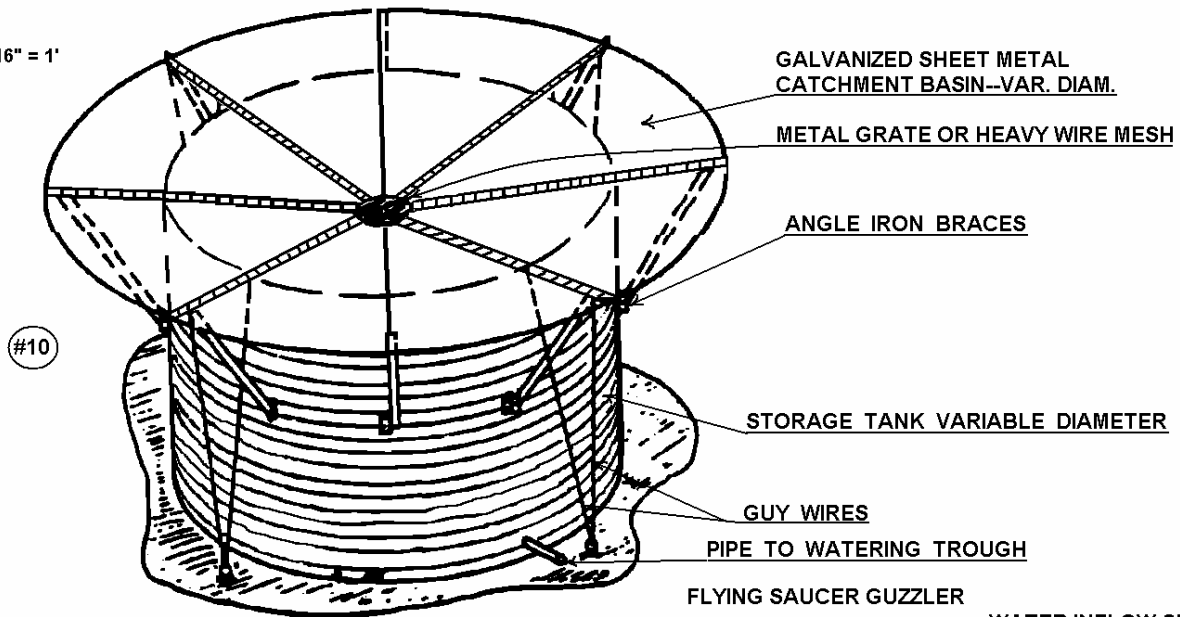

SCALE: 3/16" = 1'

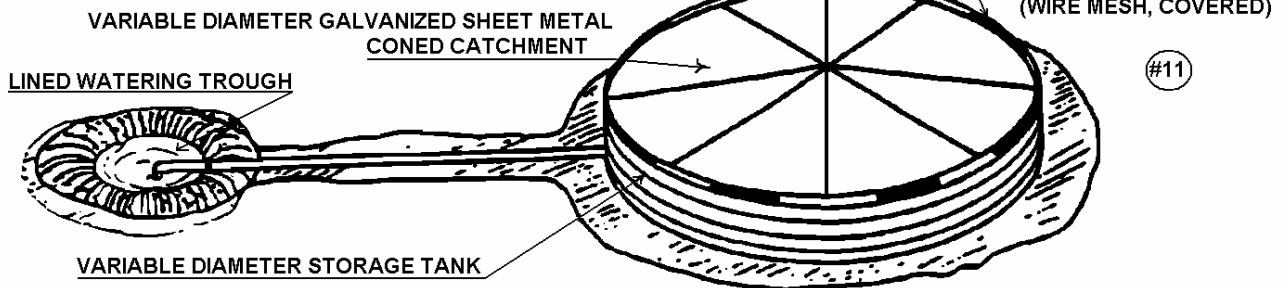

DRAWINGS BY TODD MAREK SEPT. 1991

WILDLIFE WATERING FACILITIES

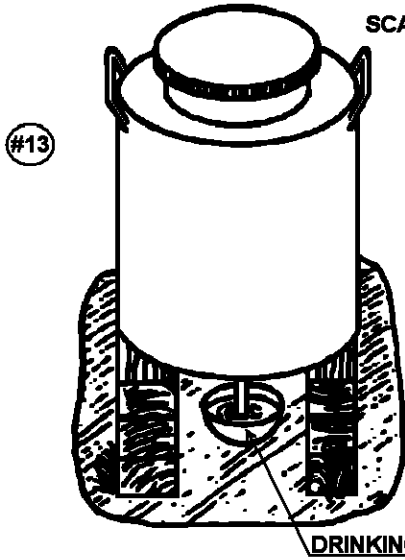
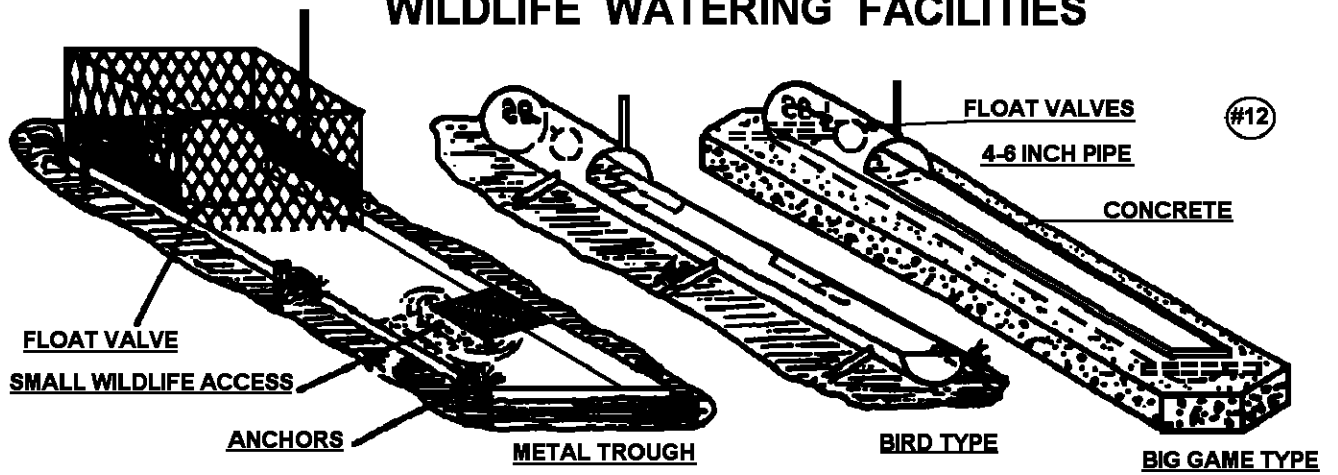

SCALE: 1 1/2" = 1'

SCALE: 1" = 1'

PLASTIC CONTAINER

FLOAT VALVE

3 FT. DIAMETER BOWL APPROX. 8 IN. DEEP

SCALE 3/4" = 1'

SCALE: 1" = 1'

SHALLOW WADING AREA

TOILET TYPE
FLOAT VALVE

CONCRETE

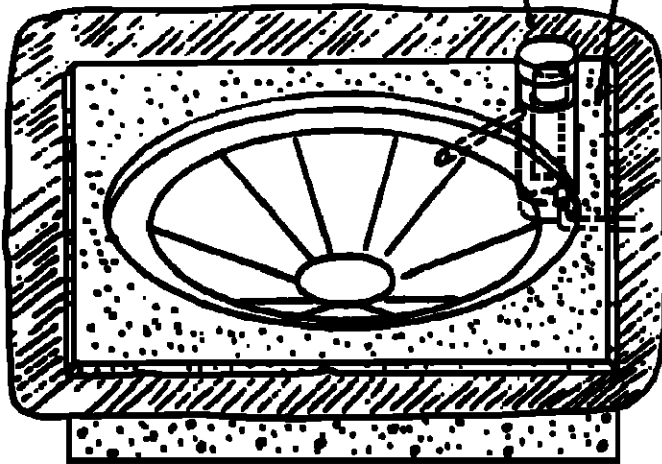

RANCH SPECIALTIES

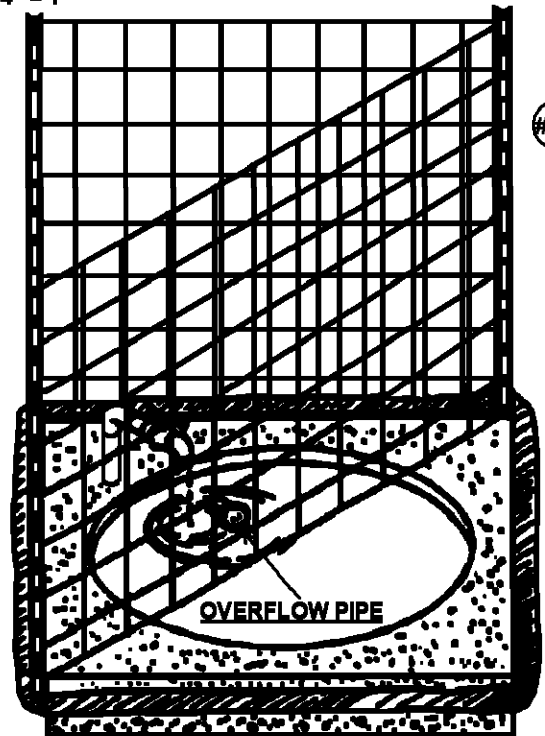

3 FT. DIAM. BOWL APPROX 8 IN. DEEP

DRAWINGS BY TODD A. MAREK

Appendix W

Trapping Brown-headed Cowbirds to Control Songbird Nest Parasitism



Trapping Brown-headed Cowbirds

The purpose of this guide is to assist landowners that wish to help songbird reproduction by building and operating a cowbird trap. Please note that all persons wishing to trap cowbirds should participate in the online training program before the trap is put into operation. This training is offered at no cost by **Texas Parks and Wildlife (TPW)**. All applicable state and federal laws must be observed during the duration of trapping. If questions arise, contact your closest **TPW** office for assistance.

Why Trap Cowbirds?

Throughout North America songbird numbers are declining. While there is no one single reason for this decline, one major contributing factor is the spread of the brown-headed cowbird. These birds were once limited to the short-grass prairies, where they followed the herds of buffalo, feeding on the insects stirred up by the movement of herds as they moved from place to place. Today however, this highly adaptive bird is found throughout North America. This is a problem because of the reproductive strategies the species employs. The cowbird is what is referred to as a brood parasite. This means the female lays her eggs in the nests of other birds, abandoning them to the care of foster parents. The foster birds raise the cowbird chick to the detriment of their own young. Because the female cowbird can lay as many as 70 eggs per season, susceptible species of songbirds, such as the black-capped vireo and the golden-cheeked warbler, that are already endangered, are particularly at risk.

Collecting Data

As with any scientific endeavor, cowbird trapping requires that data be collected in order to determine how effective it is. Collecting data also allows scientists to track the movements of banded birds, and hopefully to find new ways to reduce the parasitism rate that has caused many songbird populations to decline. By participating in this project landowners have the opportunity to help songbirds, and make a genuine contribution to the threatened and endangered wildlife in Texas.

Once the data has been collected, landowners should keep a copy, and forward a completed annual report to **Regional Migratory Bird Permitting Office for the U.S. Fish and Wildlife Service (USFWS)** by January 31st each year. This allows **USFWS** to monitor the total numbers of birds being trapped and the locations of the traps. Data to be collected should include the date, the number and type of non-target species that might get into the trap, the number of males, the number of females, and the numbers of banded birds that might be caught. *Banded birds are to be released* after the data is collected.

Selecting a Trapping Location

The location of the trap is critical to maximize cowbird capture and to minimize non-target birds being caught. The idea is to put the trap in a place that is as attractive to cowbirds as possible, without being disruptive to other species. Ideally the trap should be located in areas that include the following:

- Close to where cattle or other livestock graze.

- In open pasture, away from any brush, and in low grass.
- The trap should be readily accessible to vehicles, even after heavy rain.
- Water and some perching snag (dead trees) nearby.

Site Precautions

Even on a perfect location site there are precautions that should be taken to insure the safety of landowners and others participating in cowbird trapping.

One of the hazards to be aware of is that of predators. Any mammal, bird, or reptile that eats birds will be attracted to the traps in search of an easy meal. Keep the grass around the trap short. This will not only make it easier to spot snakes, but it will also make it more attractive to cowbirds. Raccoons and skunks will dig under the traps if precautions are not taken to keep them out. Owls and hawks also try to swoop down on the birds inside the trap. Fire ants can pose an additional hazard. Before using fire ant bait, check with your local Extension Service office for application recommendations. Always be sure to read and follow pesticide label directions. Never use any insecticides in the trap itself.

TRAP OPERATION: It is suggested that traps be operated from March 1 to May 31 ONLY. This is to avoid incidental catch of non-target species. After May 31, fledglings of beneficial species such as cardinals, mockingbirds, buntings, and finches are most abundant and are more likely to be accidentally trapped.

Setting up the Trap

Erect the trap on a level site with no gaps between the frame and the ground. Use a shovel to fill in any gaps, if necessary.

Place a one gallon poultry waterer on level ground inside the trap. Scatter about a half a coffee can of cleaned milo (grain sorghum) on the ground, being careful to avoid getting it in the water. Do not feed milo during rainy weather because the birds do not like soggy grain. Wait until the ground has dried up before scattering it out again. Each trap must contain adequate food, water and shade and be checked daily.

Since cowbirds are gregarious birds, the traps work best if about 10-15 live cowbirds are present to act as decoys. When first starting a trap without decoys, be patient. If cowbirds are in the area, they'll find and enter the trap.

Use a large minnow dip or trout net to catch birds in the trap. You must **immediately release** any non-target bird species. Any bird not a cowbird is a non-target bird. Always remove and dispose of any dead or injured birds (usually a result of avian predator attack on the trap). The most common species of non-target birds that have been found in traps are mockingbirds, cardinals, various sparrows, grackles, blackbirds, and loggerhead shrikes. Consult a bird field guide to help you identify these species. Non-target birds will enter the traps for a variety of reasons. Some are attracted to the grain, some for company, and still others just out of curiosity. Putting a board across one side at the top to provide shade to trapped birds is recommended. Humanely treating birds while in the trap and humanely euthanizing birds is important.

If a federally permitted wildlife rehabilitator is within 1 hour or less of your capture efforts, you must send injured or debilitated non-target federally protected migratory

birds to the rehabilitator. If no rehabilitator is closer than 1 hour away, you may euthanize an injured or debilitated bird of a non-target species unless the species is federally listed as an endangered, threatened, or candidate species, in which case you must deliver it to a rehabilitator and report the take to the nearest U.S. Fish and Wildlife Service Field Office or Special Agent.

For a listing of endangered, threatened birds:

http://tpwd.texas.gov/huntwild/wild/wildlife_diversity/nongame/listed-species/

For a listing of U.S. Fish and Wildlife Service Offices:

<http://www.fws.gov/southwest/es/FieldOffices.html>

For a listing of U.S. Fish and Wildlife Special Agents:

<http://www.fws.gov/southwest/lawenforcement/statecontacts.html>

Euthanizing Cowbirds

This is the real job of protecting songbirds from nest parasitism. Whichever method is used to kill cowbirds, it must be humane, fast, and certain. The recommended method is cervical dislocation, or separating the vertebra.

Cervical dislocation: Hold top of neck between thumb and forefinger, grab head with other hand, turn and lift until you feel the cervical vertebrae detach from the head – HINT: hold the bird away from you when you do this the first few times until you have the “touch”. A catch box, net, gloves, and a light for night time are useful items to have on hand.

Alternative Dispatch Methods: Carbon dioxide (CO₂) gas in a 5-gallon bucket may be used to euthanize brown-headed cowbirds. Use dry ice as the source of carbon dioxide. Cut a hole in the top of the bucket, cover opening with a piece of inner tube, or similar material, that has a slash in it to facilitate putting birds inside. Birds must not be touching the dry ice! Birds should be dead within 20 seconds.

Taking Traps out of Operation

Because cowbirds are a native species in North America, they are protected under the Migratory Bird Treaty Act. However, there are exceptions to this law for acts of depredation by a few select species. Under the **Texas Parks and Wildlife Code**, Section 64.002(c) brown-headed cowbirds are included among this small group of eight non-protected bird species that “may be killed at any time and their nests or eggs may be destroyed.” State regulations may not supersede federal regulations, so it is important that all participants in this project follow the protocols outlined here in this module. Again, it is recommended that no traps be in operation either before March 1, or after May 31.

If it is not possible to remove the trap to a location where it can be stored under cover, then certain precautions must be taken because birds, including non-target species, will tend to enter the trap. The traps may be taken out of operation by placing boards over the entry slots or by securing the door in an open position. Be sure to remove all cowbirds, and release any banded birds, disposing of any dead or injured birds.

Reporting the Data

Be sure to record all data on birds captured on an approved data form and forward copies to United States Fish and Wildlife Office in Albuquerque, New Mexico. Landowners who are actively participating in trapping brown-headed cowbirds must submit their data by January 31st each year. Submit data to:

U.S. Fish and Wildlife Service
Regional Migratory Bird Permit Offices
P.O. Box 709
Albuquerque, NM 87103

Materials List for 6x8 Portable Wood Cowbird Trap

Number	Description	Comments
16	2x4x8 (treated)	Rip 2x4 into 2x2
2	Sheets ½" CDX plywood	1 sheet is for slot assembly, 1 sheet is to cut up for gussets.
64 linear ft	½" mesh hailscreen	Bought in 100 ft. rolls
1 pair	Tight pin hinges (3")	Door hinges
1	Screen door-handle	Outside of door
1	Galvanized hasp (4½")	Use with padlock for security
1	Screen door latch	Used on inside of door
14	10"x12" shelf brackets	Used to square panels (2 per panel)
125 (approx)	1" drywall screws	Field assembly of slot assembly, attaching shelf brackets to panels.
50 (approx)	3" galvanized deck screws	Field assembly (panel to panel)
300 (approx)	1½" pneumatic staples	Used attach gussets
600 (approx)	1 pneumatic staples	Used to attach screen to panels
300 (approx)	½" staples	Used to attach screen to slot assembly

Recommended Tools For Construction

Shop Assembly of Panels

Table saw – for ripping 2x2
 Chop saw – for cutting boards to length
 Electric hand saw – for cutting out gussets and slot assembly
 Retractable rule – for measuring dimensions
 Electric or cordless drill/driver – for driving screws
 Pneumatic or electric nibbler – for cutting hail screen
 Pneumatic stapler – for attaching gussets and wire
 Pneumatic nailer – for assembly of panels
 (optional but helpful – Panels can be assembled with 3" deck screws if nailer is not available.)

Field Assembly

Cordless drill/driver – for driving screws
 Bar of soap – to lubricate screw threads
 Hand stapler – to secure wire to ends of drop entrance
 Step ladder – for attaching top panels

Construction Tips

- Use treated lumber throughout. Added initial cost is compensated for by longer field life and reduced maintenance.
- Don't rip lumber until you are ready to start construction. Ripped lumber will bow and twist if allowed to sit for several days.
- Use a shelf bracket on diagonal corners to square each panel before attaching gussets. To cut gussets, lay out sheet of plywood in 12" squares, then draw diagonals across the square. A sheet of plywood will make 64 gussets.
- Gussets go on one side of panel, hailscreen attaches to the other side. For side and top panels, wire will end up being on the inside on the panel. This prevents birds from roosting on framework next to wire where they are prone to predation. **Exception:** End panels are constructed the same way, but during final trap assembly, the wire goes on the outside, because the drop entrance attaches to horizontal members for structural stability.
- This pattern is designed to use 48" wide hailscreen to maximize efficiency. Internal cross members are placed to allow for slight overlap. Wide hailscreen will probably not be readily available in stock, but any building supply can order it. Use of narrower hailscreen requires repositioning of tack strips, and results in higher lumber use.
- To maximize shop efficiency: cut gussets; rip lumber; pre-cut lengths; cut out slot assembly; assemble side, top, and end panels; attach hailscreen; final assembly. When building multiple units, performing similar actions for several traps at the same time will allow you to develop an assembly line process that cuts construction time per unit.
- **Slot width of 1.25 inches in slot assembly is critical.** Wider slots will increase non-target captures, including small raptors, which will feed on your decoy birds. Escapes by females may also increase with wider slots.
- Side panels attach to the outside of end panels. Nothing else will fit if you attach ends outside.
- During final assembly assemble in this order: end, side, side, top, top, dropping slot assembly (3 pieces), then finish with the other end.



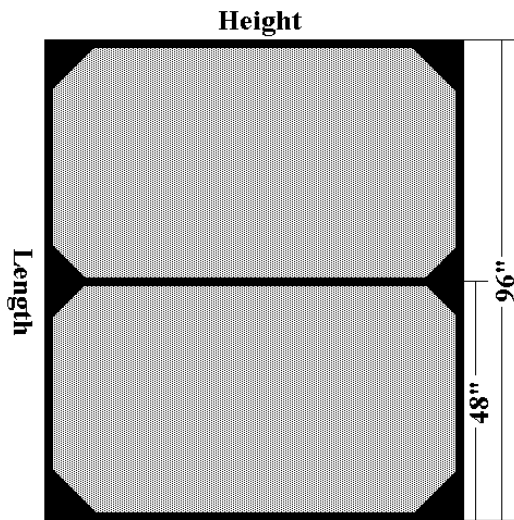

Left Side Panel (same as right panel)

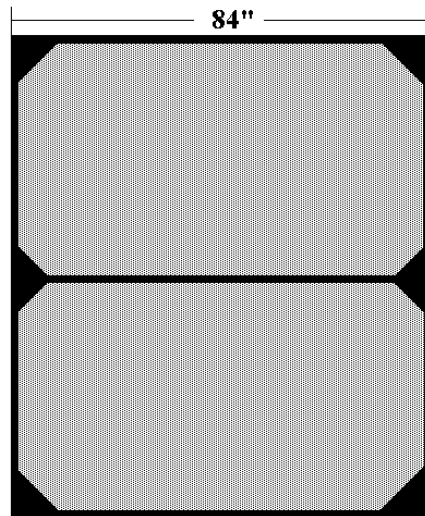

Right Side Panel

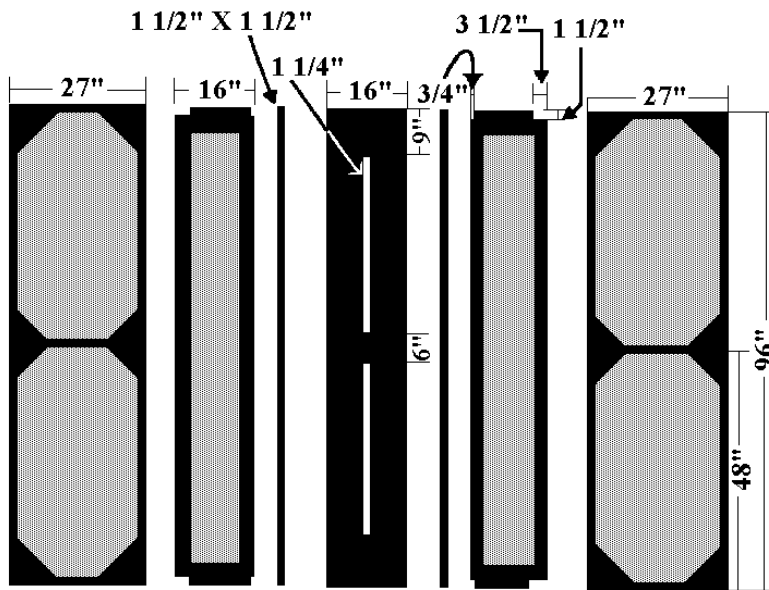

Top Panel/Slot Assembly

End View of Top Panel/Slot Assembly

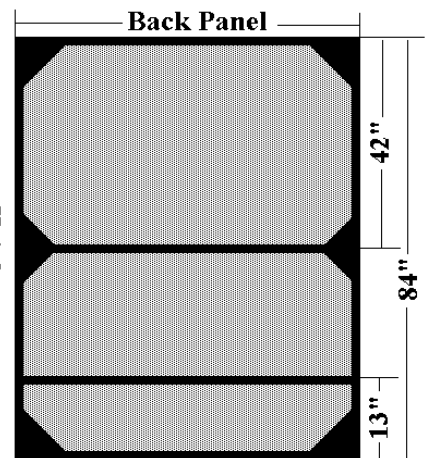

Back Panel

Cowbird Trap Plans

Plans developed by Fort Hood Environmental Division.

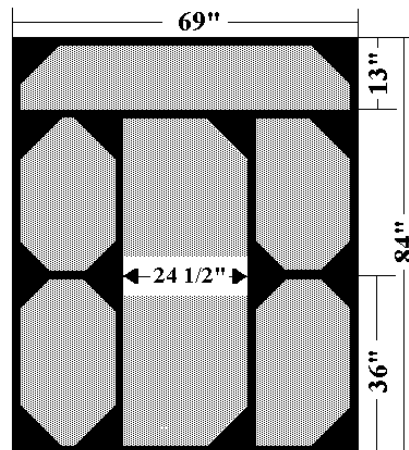

Front Panel

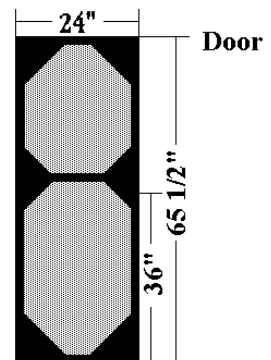

Door

Materials List for 6x8 Portable Metal Cowbird Trap

Number	Description	Comments
300	1 ½" fender washers*	attach wire to the trap frame
210 ft.	1 ½" 14 gauge square tubing	frame
16 ft.	1 ½" x 1 ½" x ⅛" angle iron	trap funnel base
15" w x 94 ½" lg	⅛" plate*	funnel entrance floor
2	2" weld-on hinges*	door hinge
1	weld-on door latch*	used to keep door secured
50 ft. of 48"	½" hardware cloth	bought in 100 ft. rolls
40 ft. of 36"	½" hardware cloth	bought in 100 ft. rolls

Recommended Tools:

220 amp electric wire feed welding machine	Vise-grip pliers
Oxyacetylene cutting torch or pipe saw	6 3 or 4 inch C-clamps
Electric drill and metal bits	Metal measuring tape
Driver for self-tapping metal screws	Wire brush
Hacksaw	Wire shears or tin snips
Hammer	Metal dirt rake

Order of Construction: *(Refer to diagram for placement before welding)*

Sides (Cuts necessary for both sides)

- 2 cuts 96" of 1 ½" x 1 ½" 14 gauge square tubing (top of side panels).
- 2 cuts 96" of 1 ½" x 1 ½" heavy gauge square tubing (base of side panels).
- 4 cuts 81" of 1 ½" x 1 ½" 14 gauge square tubing (vertical corner posts).
- 2 cuts 93" of 1 ½" x 1 ½" 14 gauge square tubing (center braces).

Front

- 2 cuts 72" of 1 ½" x 1 ½" 14 gauge square tubing (door headers).
- 1 cut 72" of 1 ½" x 1 ½" heavy gauge square tubing (base piece).
- 2 cuts 11" of 1 ½" x 1 ½" 14 gauge square tubing (bracing over the door).
- 2 cuts 22 ¼" of 1 ½" x 1 ½" 14 gauge square tubing (mid-section bracing by door).
- 2 cuts 68 ½" of 1 ½" x 1 ½" 14 gauge square tubing (doorframe).

Door

- 3 cuts 21" of 1 ½" x 1 ½" 14 gauge square tubing (top, middle, bottom bracing).
- 2 cuts 68" of 1 ½" x 1 ½" 14 gauge square tubing (sides of door).

Back

- 3 cuts 72" of 1 ½" x 1 ½" 14 gauge square tubing (top, center frame pieces).
- 1 cut 72" of 1 ½" x 1 ½" heavy gauge square tubing (base piece).
- 2 cuts 11" of 1 ½" x 1 ½" 14 gauge square tubing (top bracing pieces).

Top

2 cuts 93" of 1 1/2" x 1 1/2" 14 gauge square tubing (upper frame for trap funnel).
2 cuts 93" of 1 1/2" x 1 1/2" x 1/8" angle iron. (lower trap entrance plate supports).
15" wide x 94 1/2" long 1/8" plate (trap entrance plate). Cut two openings 36 1/4" x 1 1/4" as shown in the diagram. *The exact 1 1/4" width of each opening is critical. (Note: If desired, this plate can be made of wood, rather than metal.)*

Wire Mesh covering

Center the wire at the door and wrap it around the entire trap, using a dirt rake to pull the wire tight. Don't forget to cover the floor of the trap (this will help keep predators out). Attach the wire to the frame with fender washers and self-tapping screws placed every 12 inches apart.

Door: 1 piece 67 3/4" x 23 1/2". Trim to fit.

Placement Notes:

- A. 1/4" gap on hinge side of door between door and frame.
- B. Hinge starts 10" from the top.
- C. Hinge starts 10" from the bottom.

***ALTERNATE CONSTRUCTION METHODS**

Attaching Wire Mesh (Alternate Method)

If desired, the screen mesh can be attached to the trap using 130 feet of 1" x 1/8" strap, and 275 self-tapping metal screws. Make the following cuts if this method is used:

Front: 2 – 74 1/2"	Both Sides: 6 – 95 3/4"
2 – 23 1/2"	4 – 6"
2 – 27 1/2"	
2 – 11"	Rear: 3 – 74 1/2"
	2 – 11 1/2"
Door: 3 – 23 1/2"	1 – 19"
2 – 21" (upper sides)	
2 – 42 3/4" (lower sides)	Center Trap Angle: 2 – 93"

Hold all screen in place with 1" x 1/8" plate with screws placed every 6 inches.

Alternate Door Hinges and Latch Construction:

Note: Put door latch on first, then install frame latch to fit.

1 ft. of 1" x 1/4" strap
2 ft. of 3/8" tubing
2 ft. of 7/16" rod

Make the following cuts:

4 cuts 2" of 3/8" tubing (door hinge part)

2 cuts 5" of 7/16" rod (door hinge part)
1 cut 7" of 1" x 1/4" strap (door latch)
1 cut 5" of 1" x 1/4" strap (on door)
1 cut 2" of 3/8" tubing (on door)
1 cut 3 1/4" 7/16" rod

Alternate Trap Entrance Plate:

2 pieces of plate 7" wide x 94 1/2" long, separated by 1 1/4" inches that will form the opening. *The exact 1 1/4" width of the opening is critical.*

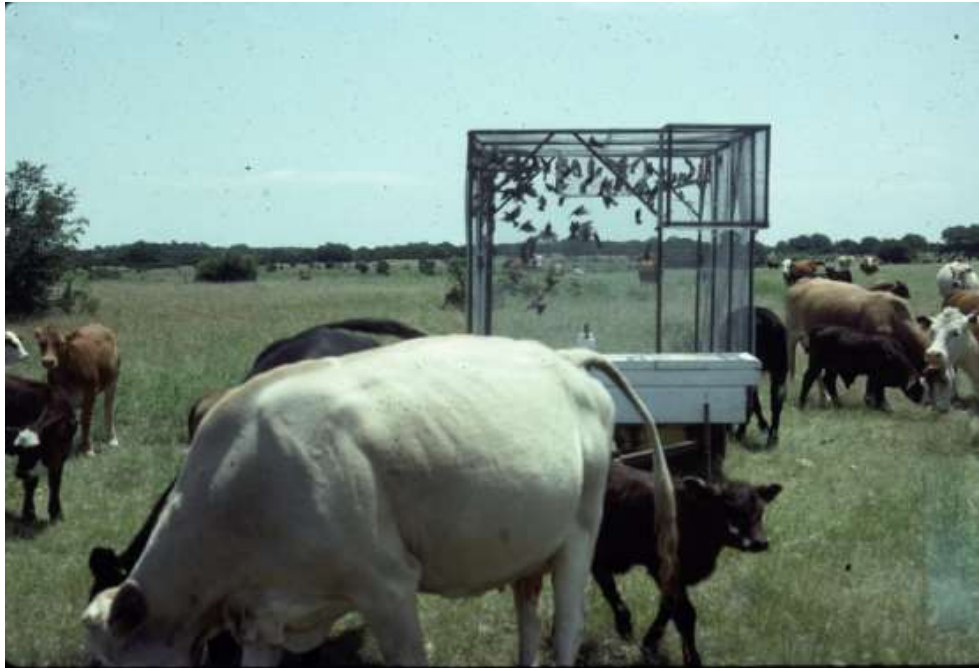

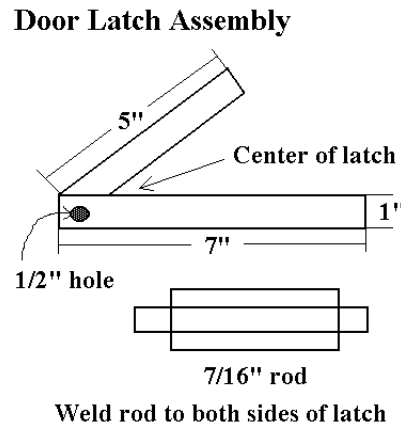
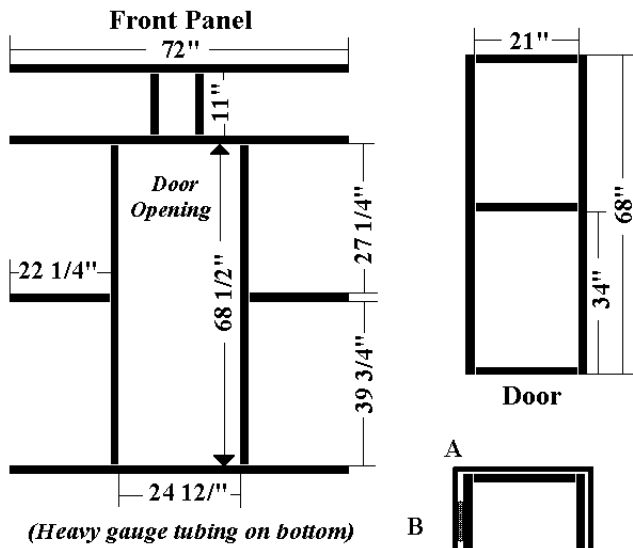
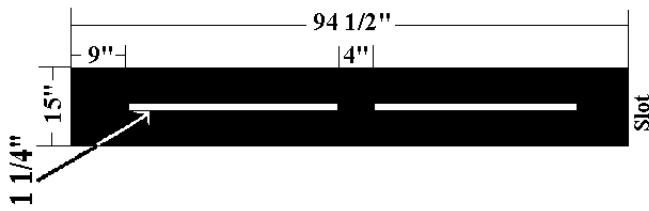
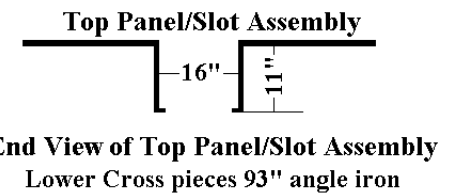
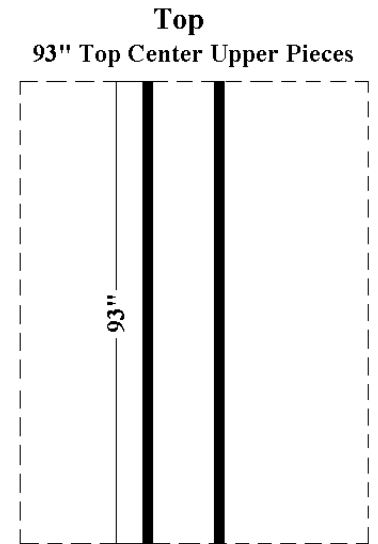
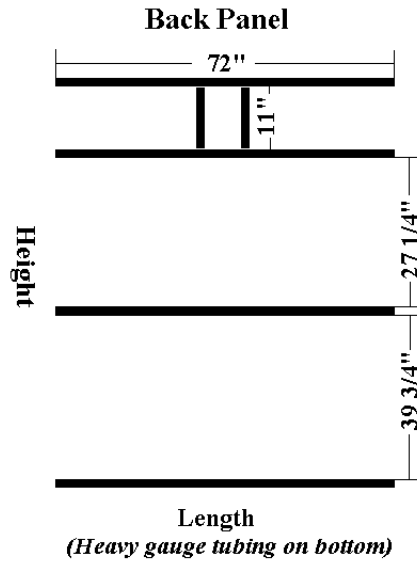
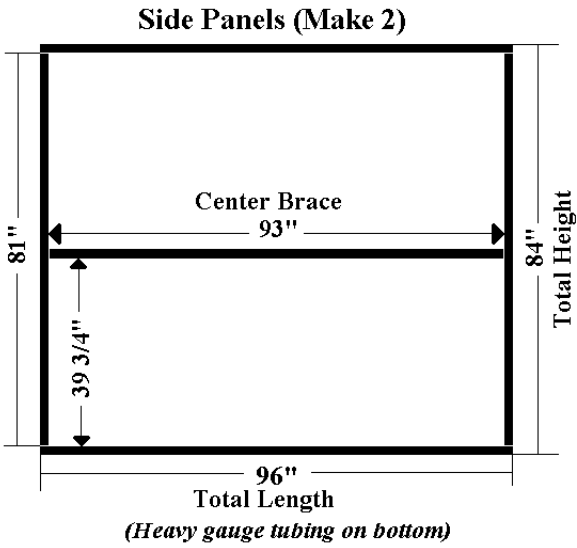

- A. 1/4" gap between hinge side of door between door and frame.
- B. Hinge starts 10" from top.
- C. Hinge starts 10" from bottom.

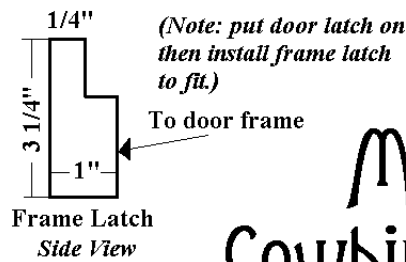
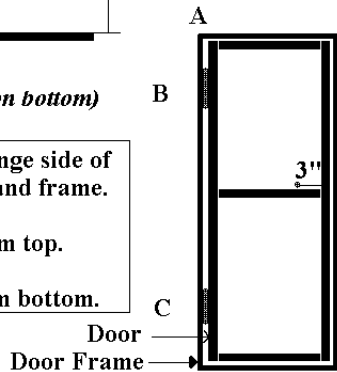

Metal Cowbird Trap Plans

APPENDIX X

References

Literature

Refer to the following bulletins and pamphlets developed by the Texas Parks and Wildlife Department (TPWD), Natural Resources Conservation Service (NRCS), Texas Agricultural Extension Service (TCE), and other agencies/universities for additional habitat management and species management information:

Habitat:

Prescribed Range Burning in Texas by L.D. White and C. W. Hanselka, TCE, Reprinted by TPWD, # PWD-BK-7100-196-7/91

Wetlands Assistance Guide for Landowners by J. K. Anderson, TPWD, #PWD BK R2000-020 (7/95)

Brush Sculptors (Symposium Proceedings), edited by D. Rollins, D Ueckert, and C. Brown, TCE and TAES. 150 pp. (1997)

Proceedings of the 1997 Juniper Symposium, edited by C. Taylor, TAES, Technical Report 97

Managing Livestock Stocking Rates on Rangeland, edited by J. Cox and J.F. Cadenhead, TCE, 147 pp. (1993)

The Use and Management of Browse in the Edwards Plateau of Texas, NRCS, November 1994

Basics of Brush Management for White-tailed Deer Production, by T. Hailey, TPWD, PWD-BK-7100-35-12/88

Managing Riparian Habitats for Wildlife, TPWD, PWD Brochure W7100-306 (06/98)

Water for West Texas Wildlife, by T. Bone, R. Cantu, and S. Brownlee, TPWD, PWD Booklet N7100-32-7/93

Mule Deer:

Mule Deer Management in Texas, by R. Cantu and C. Richardson, TPWD, PWD-BK-W7100-303 (7/97)

Managing Desert Mule Deer, by D. Rollins, TCE, B-1636 (8/89)

Managing Plains Mule Deer in Texas and Eastern New Mexico, by F. Bryant and B. Morrison, Tex. Tech Univ., T-9-414

White-tailed Deer:

Learn About Whitetails by R. L. Cook, # PWD-BK-N7100-7-2/93

Determining the Age of a Deer by C. W. Ramsey, D. W. Steinbach, D. W. Rideout , TCE #B-1453

Supplemental Feeding for Deer: Beyond Dogma (Symposium Proceedings), edited by C. Ramsey, Texas A&M Univ. 153 pp. (1996)

The Management of Spike Bucks in a White-tailed Deer Population by B. Armstrong, D. Harmel, B. Young, and F. Harwell, TPWD, #PWD LF N7100-247 (8/94)

Supplemental Feeding by J. R. Perkins, TPWD, #PWD-BK-N7100-033-11/91

Harvest: An Essential Strategy For White-tailed Deer Management by F. Harwell, TPWD, PWD BR N7100-244 (4/94)

Deer Management In The Edwards Plateau of Texas by D. Harmel and G. Litton, TPWD, PWD Booklet 7000-86, March 1983

Managing Habitat for White-tailed Deer in the Hill Country Area of Texas, by W. E. Armstrong, TPWD, PWD-RP-7100-193-4/91

Pronghorn Antelope:

Texas Pronghorns, by D. Swepston and T. Hailey, TPWD, PWD Booklet 7100-46-10/91

A Handbook for Pronghorn Antelope Management in Texas, by T. Hailey, TPWD, PWD Booklet 7100-46-3/86

Bighorn Sheep:

Man -- the greatest enemy of desert bighorn mountain sheep, by B. Carson, Texas Game, Fish and Oyster Commission. Bull. 21 (1941)

Habitat requirements of desert bighorn sheep, by G. W. McCarty and J. A. Bailey. Colo. Div. Of Wildl., Spec. Rep. No. 69, Denver (1994)

Javelina:

Learn About Javelina, by J. E. Ellisor, TPWD, PWD Leaflet 9000-96 (03/81)

Distribution of Collared Peccary in Texas, TPWD, PWD Leaflet 9000-89 (04/80)

Characteristics and Habitat Selection of a Collared Peccary Population in the Trans-Pecos, by M. C. Green, Sul Ross St. Univ., M.S. Thesis (1998)

Turkey:

Rio Grande Turkey Habitat Management by G. W. Litton and F. Harwell, TPWD, # PWD RP W7100-263 (10/95)

Scaled Quail:

Effects of hunting and some other environmental factors on scaled quail in New Mexico, by H. Campbell, D. Martin, P. Ferkovich, and B. Harris, The Wildlife Society, Wildlife Monograph No. 34. Bethesda, MD. 49 pp. (1973)

Habitat Requirements of Breeding Scaled Quail in Texas, by R. Reid, C. Grue, and N. Silvy, Texas A&M Univ., Quail III National Quail Symposium (1993)

Ecology and Management of Blue Quail in Texas, by D. Rollins, TCE, Proceedings of the Texas Quail Shortcourse II

Ecology of Scaled Quail in West Texas, by O.C. Wallmo, Texas Game and Fish Commission, Austin (134 pp.)

Bobwhite Quail:

Bobwhite Quail in Texas-Habitat Needs and Management Suggestions by A.S. Jackson, Clyde Holt, and Daniel Lay, TPWD, # PWD Brochure 7000-37 5/84

Bobwhite Facts & Fantasies by Horace Gore and Don Wilson, TPWD, #PWD Leaflet C2000-063 (11/87).

Preserving Texas' Quail Heritage into the 21st Century (Symposium Proceedings), edited by K. Cearley, TCE. 163 pp. (1999)

The 182 page book "Beef, Brush and Bobwhites - Quail Management in Cattle Country" by F. S. Guthery. Published by the Caesar Kleberg Wildlife Research Institute, Texas A&I University (now Texas A&M at Kingsville), Kingsville, Texas in 1986.

Dove:

Mourning Doves in Texas, Life History, Habitat Needs, and Management Suggestions by R. R. George, TPWD, #PWD-BK-7100-009A-3/88

Feral Hog:

The Feral Hog in Texas by R. Taylor, TPWD, #PWD-BK-7100-195-10/91

Black Bear:

The Black Bear Returns to Texas, by R. Taylor, N. Garner, and M. Wagner, TPWD, PWD Brochure W7100-311 (12/97)

Mountain Lion:

Mountain Lions in Texas, TPWD, PWD Brochure W7100-232 (10/95)

Purple Martin:

The Purple Martin and Its Management in Texas by J. D. Ray, TPWD, # PWD BK W7100-254 (04/95)

Exotics:

Exotics in Texas, by M. Traweek and R. Welch, TPWD, PWD Booklet N7100-206 (5/92)

The Aoudads of Palo Duro Canyon, by C. Richardson and D. Dalchau-Wright, TPWD, PWD Booklet 7100-294 (10/96)

Exotic Big Game: A Controversial Resource, by S. Demarais, D. Osborn, and J. Jackley, Reprinted from Rangelands 12(2), April 1990

Exotic Mammals: Competing with the Natives, by W. Armstrong and D. Harmel , TPWD, PWD Leaflet 9000-103 (1981)

Threatened/Endangered Species

Endangered and Threatened Animals of Texas - Their Life History and Management by Linda Campbell (1995)

Horned Lizards: Some Protected Species, TPWD, PWD L-9000-12-5/86

Other Nongame:

Faanes, C.A. 1987. Bird behavior and mortality in relation to power lines in prairie habitats. U.S.Fish and Wildl. Serv. Tech. Rep. 7. (31pp.).

Mitchnick, A.D. 1979. Avian populations of urban woodlands: comparisons, habitat requirements, and management implications. M.S. Thesis, Texas A&M Univ., College Station. 120pp.;

Mitchnick, A.D., and R.D. Slack. 1979. Comparison and management of avian populations of urban woodlands. Am. Ornithol. Union 97:51

Owens, L.K. 1989. Avian use of fencerow habitat in a predominantly agricultural area. Ph.D. Thesis, Texas A&M Univ., College Station. 157pp

Texas Wildscapes Program. Texas Parks and Wildlife Department, 4200 Smith School Road, Austin, Texas, 78744.

Appendix Y

Recommendations for Restoring Desert Grasslands

Importance of Grasslands

Native grasslands, with their ecologically complex plant and animal communities, were an important component on the landscape of early Texas. They were dominant features on the landscape in the Edwards Plateau, Cross Timbers and Prairies, Coastal Plains, High Plains, Rolling Plains, and Trans-Pecos. They contributed significantly to forage production for livestock grazing and habitat for a wide variety of wildlife species. Texas Parks and Wildlife recognizes the importance of native prairies and grasslands and their function as habitat for many wildlife species including native and migratory birds, small and large mammals, reptiles and amphibians, insects, and invertebrates. In many regions of Texas, soils that once supported these vast plant communities of native perennial grasses and forbs now maintain a thriving farming economy. Most of these lands are now devoted to the production of wheat, milo, corn, cotton, hay, improved pastures, and an array of other cash crops to meet our demands for food and fiber. Grasslands in the Trans-Pecos are used extensively for livestock grazing and many still support a diversity of wildlife species. Some of these grasslands, especially where irrigation is possible, have been converted to cropland or improved (non-native grass) pasture. However, one of the greatest problems for grasslands in the Trans-Pecos is the gradual but steady encroachment of brush species such as mesquite, creosotebush, and tarbush.

Desert Grassland Restoration

There exists a prevalent problem throughout much of the Trans-Pecos that poses a great challenge – the recovery or restoration of vast areas that are now devoid of all herbaceous vegetation. These particular shrublands consist of virtually pure stands of creosotebush and/or tarbush. Some of these areas are gradually losing their soil, while other areas have long since lost all appreciable amounts of soil. The remaining soil exists as pedestals at the bases of the creosote and tarbush shrubs. Unfortunately, this is not a static situation and many grasslands are currently in a transition phase toward increasing brush densities, dying grasses, and increasing soil exposure. That is, many healthy grasslands are undergoing the initial phases of this process, and some existing “badlands” are expanding (becoming larger) into surrounding grasslands.

Creosote and tarbush have long been components of the Chihuahuan Desert, but to a much lesser extent than current densities and distribution. Historically, these invading shrubs were severely limited by periodic fires that occurred primarily in summer (lightning strikes and fires set by native Americans). For the past 100-120 years, the occurrence of fire in the Trans-Pecos has been greatly reduced. This is a result of active protection of residents and structures (firebreaks and fire-fighting), inadvertent firebreaks (highways, county roads, railroads, etc.), and the reduction of fine fuels by

livestock grazing. There is historical evidence that fires in the southwest deserts occurred on average about once in 10 years (see Appendix F – Recommendations for Prescribed Burning in West Texas). Fires were frequent enough and intensive enough (heavier loads of fine fuels) to control saplings and seedlings of invading shrubs. Over a period of several decades without fire, invading shrubs have been allowed to increase in size and density. In far west Texas where soils are generally shallow, and rainfall is limited and highly erratic (seasonally and annually), grasses can tolerate very little competition for moisture and nutrients. In most years, livestock grazing pressure that exceeds “light” can further reduce the ability of grass plants to compete and survive.

The effect of invading shrubs on grassland health and vigor can be observed in several stages:

Stage 1 – healthy desert grassland with few or no invading shrubs (scattered cholla and/or yucca may be present)

Stage 2 – healthy grasses with light density of invading shrubs (creosote or tarbush)

Stage 3 – scattered grasses with considerable exposed soil (moderate density of invader shrubs)

Stage 4 – very light grasses, much exposed soil, considerable wind and sheet erosion, heavy density of invader shrubs

Stage 5 – grasses are absent, most soil has been lost and is down to gravel layer, invader shrub on soil “pedestals”

Very little progress can be made with areas in the Stage 5 condition. Restoration efforts would be expensive, and results would be very gradual. Recovery efforts in areas where soils have been lost must involve techniques that replace soil/organic matter on the ground, followed by seeding to accelerate the recovery process. One technique with some potential for small-scale projects involves the development of a berm down-slope of the target area to catch run-off during rainfall events. Over a period of years, the run-off may deposit enough sediment on the gravelly “wasteland” to support early succession seedlings or a grass-seeding effort. The restoration effort must also include the mechanical or herbicidal control of competing shrubs prior to establishment of grass seedlings.

There is another technique with some potential on localized (small) areas where the development of a berm is not possible. This method involves fencing of the area and feeding/haying cattle herds on a temporary basis (winter) to deposit organic matter (hay residue and manure) on the area to be seeded. This process would have to be repeated several times until an adequate amount of organic matter was present to support a seeding effort. To avoid losing freshly deposited organic matter through wind or sheet erosion, the hay residue and manure should be incorporated into the ground immediately following cattle removal in late winter (hoof-action may be ineffective on gravelly substrates). This can be done with a chisel plow or heavy offset disk (depending on shrub size) which also will uproot and/or stress many of the competing shrubs. After an adequate amount of organic matter has been deposited and following mechanical control of shrubs, a mixture of native grass seed can be worked into the

soil. Pioneering grass seedlings and clumps would be protected by fencing with the expectation that they would over time intercept additional organic matter (wind-borne dust and run-off sediment during rainfall events).

The only technique with potential on a large scale is the use of a chisel or ripper to establish alternating strips of treated and untreated brush along the contour. This practice will remove much of the competing brush, improve water infiltration, and allow sedimentation from up-slope runoff. The untreated strips will help to prevent further erosion and provide a watershed for treated strips down-slope. Over a period of years, the treated strips should intercept enough soil for grass seedling establishment, and the mechanical technique can be repeated on the untreated strips.

Some improvement can be expected with areas in the Stage 4 condition, as there are remnant grass clumps, soil, and presumably a seed source. A more rapid management response can be achieved for areas in the Stage 3 condition, while the management of Stages 1 and 2 is the easiest and least expensive (prescribed fire).

There are several options for grassland restoration of Stages 3 and 4. These alternatives include broadcast herbicide treatment and mechanical treatment. Mechanical treatment may be in the form of root removal (root-plow, chisel, heavy offset disk, etc.) or top removal (Lawson aerator, chaining, cabling, roller-chopping, etc.). Either treatment category should be conducted in parallel strips (~2 tractor widths) along the contour so that about 50% of the target area is treated. For flat areas, the treatment strips should be established perpendicular to the prevailing wind direction. The untreated strips will protect exposed soil in adjacent strips and prevent erosion (slow run-off) until grasses become established in the treated strips. Root-removal techniques may require grass-seeding to accelerate the recovery process. After grasses become established in the treated strips (will require several years), the process is duplicated on the untreated strips. Extended drought following the treatment will slow and/or reduce the grass response but may result in increased mortality of woody plants. The benefits of this rather expensive and labor-intensive process will be short-lived without the periodic implementation of prescribed fire to prevent the re-invasion of creosote and/or tarbush.

Summary

It is not possible to totally replicate the native grasslands that once existed in the different ecological regions of Texas. Only with time can land truly evolve through the stages of natural plant succession to replicate the diverse flora and fauna characteristic of climax native grasslands. There are land management steps that can be taken to speed up this process by reintroducing native plants or their cultivars on those lands that once supported native grasslands. Each ecological region will require different techniques, planting procedures, species selections, and site preparations to be successful. It will be imperative that a coordinated effort be made to draw upon the expertise of other agencies and groups with knowledge and training on native grassland and prairie restoration before undertaking a restoration project. Agencies such as the

United States Department of Agriculture Natural Resources Conservation Service (NRCS), Texas Agricultural Extension Service, Soil and Water Conservation Districts, Native Prairies Association of Texas, Texas Parks and Wildlife Department, United States Forest Service, and universities are logical sources of information concerning the specifics to formulate grassland restoration plans. Many of these organizations have identified successful techniques and procedures through research and demonstration projects in different parts of Texas. No plan should be considered complete that has not taken into consideration the experience and knowledge already available from such sources.

APPENDIX Z

The Trans-Pecos

The Trans-Pecos is perhaps the most remarkable eco-region of Texas, offering at once breathtakingly spectacular vistas and incredible biological diversity. Located west of the Pecos River are 19 million acres featuring an impressive array of habitats from desert grasslands, desert scrub, salt basins, sand hills, and rugged plateaus to wooded mountain slopes whose summits support mixed hardwood and coniferous forests (Correll and Johnston, 1979).

The Trans-Pecos combines Chihuahuan desert flats with more humid mountain ranges of diverse geological origin to create a living museum of biological wonders. More rare and endemic species are found among its desert valleys, grassy plateaus, wooded mountains and protected canyons than in any other part of Texas. Indeed, 1 out of 5 Texas endemic plants occurs here and nowhere else.

The Trans-Pecos cannot really be considered a single unit at all. For what occurs on the summit of the south rim of the Chisos Mountains--alligator juniper, Texas madrone, ponderosa pine, for example--bears no resemblance to the vegetation of the surrounding desert -- creosote, tarbush, ocotillo, and lechuguilla. Parts of this region are the hottest and driest in Texas with the western-most reaches receiving a scant 8 inches of annual rainfall, sometimes even less. With elevations ranging from 2,500 feet to slightly over 8,500 feet, precipitation levels increase with increasing elevation which gives rise to more moisture-loving communities in the mountainous areas. Soils are exceedingly complex ranging from very alkaline limestone-derived soils to highly acidic volcanically derived soils. The average annual temperature of 64^o over the entire area does not reflect temperature extremes, heat being an important feature of the area. Indeed, the Trans-Pecos region as a whole represents the largest U.S. portion of true Chihuahuan Desert.

Dominated by creosote-tarbush desert scrub grasslands, there are scattered inclusions of montane ponderosa pine forest, pinyon pine and oak forests; yucca and juniper savannahs, grama grasslands, and saltbush and alkali sacaton dominated salt basins. Much of the landscape is dominated by desert grassland, but many of the desirable grasses have been replaced by lower quality plants under continuous overgrazing. Stream courses or riparian areas are the oases of the desert, yet few remain relatively undisturbed. These areas support stands of willows, cottonwoods, sycamores, ash, and little walnuts. In these spring canyons, plants that cannot tolerate the rigors of dry desert conditions find refuge in the cool, moist surroundings.

A total of 54 species of birds are primarily confined to this region, among them the Crissal Thrasher, the Black-tailed Gnatcatcher, Gambel's Quail, and Lucy's Warbler (Fisher, 1984). In fact, the Chisos Mountains is the only place in Texas where the Lucifer Hummingbird, Gray-breasted Jay, Hutton's Vireo, and Painted Redstart can be reliably found. Reptiles abound, notable among them the eastern collared lizard, southwestern blackneck garter snake and the Trans-Pecos rat snake.

Mammals are equally diverse with Mexican long-tongued bat, Spotted bat, Texas antelope squirrel, Kit fox and bighorn sheep occurring mainly in this region. Long gone are the native populations of wapiti and grizzly bear. Black bear and mountain lions can still be found. And finally, unique species of desert-adapted and relict pupfish, mosquito

fish and shiners inhabit the few remaining undisturbed desert watercourses and cienegas.

TEXAS WILDSCAPES NATIVE PLANT TABLES BIBLIOGRAPHY - TRANS-PECOS

The following references were used to compile the above tables and regional description of the Trans-Pecos:

- Ajilvsgi, G. 1984. Wildflowers of Texas. Bryan, Texas: Shearer Publishing Inc.
- Ajilvsgi, G. 1991. Butterfly Gardening for the South. Dallas, Texas: Taylor Publishing Company.
- Correll, D. and M. Johnston. 1979. Manual of the Vascular Plants of Texas. Richardson, Texas: University of Texas.
- Cox, P. and P. Leslie. 1988. Texas Trees; A Friendly Guide. San Antonio, Texas: Corona Press.
- Gould, F. 1975. The Grasses of Texas. College Station, Texas: Texas A&M University Press.
- Gould, F., G.O. Hoffman, and C.A. Rechenhain. 1960. Vegetational Areas of Texas. College Station, Texas: Texas Agricultural Experiment Station L-492.
- Peterson, R.T. et al. 1974. Gardening with Wildlife. Washington, D.C.: National Wildlife Federation.
- Powell, M.A. 1988. Trees and Shrubs of Trans-Pecos Texas Including Big Bend and Guadalupe Mountains National Park. Big Bend National Park, Texas: Big Bend Natural History Association, Incorporated.
- Simpson, B.J. 1989. A Field Guide to Texas Trees. Austin, Texas: Texas Monthly Press.
- Texas General Land Office. 1980. "The Natural Heritage of Texas." Austin, Texas: Nature Conservancy.
- Tufts, C. 1988. The Backyard Naturalist. Washington, D.C.: National Wildlife Federation.
- Vines, R.A. 1960. Trees, Shrubs, and Woody Vines of the Southwest. Austin, Texas: University of Texas Press.
- Warnock, B.H. 1970. Wildflowers of the Big Bend Country, Texas. Alpine, Texas: Sul Ross University Press.
- Warnock, B.H. 1974. Wildflowers of the Guadalupe Mountains and the Sand Dune Country, Texas. Alpine, Texas: Sul Ross University Press.
- Warnock, B.H. 1977. Wildflowers of the Davis Mountain and the Marathon Basin, Texas. Alpine, Texas: Sul Ross University Press.
- Wasowski, S. and A. Wasowski. 1989. Native Texas Plants: Landscaping Region by Region. Austin, Texas: Texas Monthly Press.
- Wauer, R.H. 1980. Naturalist's Big Bend. College Station, Texas: Texas A&M Press.
- Wilson, J. 1991. Landscaping with Wildflowers. Boston: Houghton Mifflin Company.
- Winckler, S. 1982. Texas Diversity: From the Piney Woods to the Trans-Pecos. In: The Nature Conservancy News: 32(5)

Wildscapes Plant List -- Trans-Pecos

SPECIES	FAMILY	HABIT/ HEIGHT	FLOWER	FRUIT TYPE	SUN EXPOSURE	HABITAT	SOILS & MOISTURE REGIME	VEGETATION ZONES										ORNAMENTAL VALUE	WILDLIFE VALUE	
								1	2	3	4	5	6	7	8	9	10			
Arbutus xalapensis Texas madrone	Ericaceae Heath Family	Tree, medium 20' - 30'	Small white to pinkish urn-shaped flowers Feb. - April	Berries, bright red. Sept. - Oct.	Part shade	Prefers wooded, rocky canyons & limestone bluffs	Sands, loams & clays. Likes limestone, caliche-like soils. Well-drained, mesic.								X			X	Absolutely gorgeous multi-trunked ornamental tree with papery thin peeling bark. Soft cream-colored spring bark turns reddish in summer. Urn-shaped flowers set off nicely from dark green leathery leaves. Can be hard to grow, but worth it. Evergreen.	Flowers attract several kinds of insects. Berries are sought after by several species of birds & small mammals, also by white-tailed deer.
Bumelia lanuginosa Woolly-bucket bumelia	Sapotaceae - Sapodilla Family	Tree, large 40' - 80'	White perfect flowers, fragrant. June - July	Berries, blue-black. Sept. - Oct.	Full sun, Part shade	Mostly uplands, sometimes bottomlands, woodlands, edges and fencerows.	Sandy loams, loams, and clays. Tolerates gumbo. Well-drained, mesic.	X	X	X	X	X	X	X	X	X	X	X	Large shade tree with simple green leaves with white woolly undersurface. Persistent.	Several species of birds feed on the fruit, including cardinals, finches, robins, cedar waxwings, warblers, and vireos. Good cover and nesting tree due to protective thorns. Good substrate for insectivorous birds.
Celtis reticulata Net-leaf hackberry	Ulmaceae - Elm Family	Tree, medium to small 15' - 30'	Inconspicuous greenish flowers, small & perfect. May - June	Drupe, orange-red. Aug. - Sept.	Full sun, part shade	Prefers wooded limestone slopes. Mostly restricted to North Central, Central & parts of South Texas.	Sands, loams, & clays. Likes limestone & caliche-type soils. Well-drained, mesic-xeric.	X		X	X			X	X	X	X	X	Can grow to be a shade tree with thickish rough-surfaced leaves with net-like veins on undersurface. Trees are strongly taprooted & extremely drought-tolerant. Deciduous.	Fleshy fruits persist on this tree in the winter making it a valuable food source for all kinds of birds: robins, cedar waxwings, bluebirds, cardinals, finches & sparrows. Fine substrate for insectivorous birds. LHP for hackberry, snout & ? butterflies.
Fraxinus berlandieriana Fresno	Oleaceae - Olive Family	Tree, large 30' - 40'	Panicles of m & f greenish purple & green flowers. March - June	Samara. June - Aug.	Full sun, part shade	Grows along wooded streams, in canyons of the Edwards Plateau & Rio Grande Valley, also parts of West Texas.	Sands, loams, clays; likes limestone, caliche-like soils. Well-drained, but moist soils.	X						X	X			X	Spreading, round-topped tree. Fairly fast growing & long-lived. Deciduous.	Good cover and nesting tree. Cardinals, pyrrhuloxias, finches, red-winged blackbirds relish seeds. Foliage browsed by rabbits and mule deer. Larval host plant for swallowtail butterflies.

Fraxinus cuspidata Fragrant ash	Oleaceae - Olive Family	Tree, medium to small 15' - 25'	Panicles, 3"-4", of m & f cream-colored flowers, fragrant. June.	Samara. July	Full sun, part shade	Prefers rocky canyon slopes in Trans-Pecos, gravelly hillsides from 4000'	Sands, loams, clays; likes limestone, caliche-like soils, also slightly acidic igneous soils. Well-drained, mesic-xeric.	X	Very ornamental small to medium-sized tree that looks a bit like the East Texas Fringe tree. Quite drought-tolerant, but grows faster with additional water. Deciduous.	Good cover and nesting tree. Cardinals, pyrrhuloxias, finches, red-winged blackbirds relish ripe seeds in samaras. Foliage browsed by crabbits and mule deer. Larval host plant of swallowtail butterflies.
Fraxinus greggi Gregg ash	Oleaceae - Olive Family	Tree, medium to small 15' - 25'	Perfect, male or female or both can occur on same or different trees. March - May	Samara. July - Sept.	Full sun, part shade	Prefers dry rocky hillsides & arroyo banks in Trans-Pecos, also dry creek beds & washes from 4000 - 7000'	Limestone & caliche soils. Well-drained, xeric.	X	Small to medium-sized tree with trifoliolate compound leaves & smooth iron gray bark. Quite ornamental and very drought-tolerant. Can form thickets or clumps. Deciduous.	Good cover and nesting tree. Birds are very fond of the seeds contained in the samaras. Excellent mule deer browse.
Fraxinus velutina Velvet ash	Oleaceae - Olive Family	Tree, large 30' - 50'	Furry panicles. April - June or March - May, depending on altitude.	Samara. Sept.	Full sun, part shade	Prefers areas around arroyos where water is available. Occurs along rivers, streams, dry streambeds & narrow canyons	Sands, loams, clays, caliche & limestone soils. Well-drained, mesic.	X	This is an excellent landscape plant, easily reared from seed. Grows rapidly & is not susceptible to borers. Very ornamental. Prefers north side of hillsides. Deciduous.	Good cover and nesting tree. Birds are very fond of the seeds contained in the samaras. Excellent mule deer browse. Leaves browsed by other herbivores.
Populus fremontii v. mesetae Meseta cottonwood	Salicaceae - Willow Family	Tree, large 30' - 60'	Inconspicuous m & f catkins red & yellow. March - June	Brown f capsules with cottony seeds. May - June	Full sun, part shade	Prefers moist soils along streams or water holes from sea level to 7000'	Likes rocky or deep alluvial soils: sands, loams clays & caliche. Well-drained, mesic.	X	This is the most common poplar in Presidio, Brewster & Jeff Davis counties. Has excellent fall color. Some cities don't allow this tree because of its copious "cotton" fallout in the spring. Deciduous.	Foliage, bark, seeds & leaves important to wildlife esp. deer & rabbits. Seeds eaten by many birds, esp. pyrrolloxias & cardinals. Cottony seeds used to line nests. Foliage is browsed by mule deer. Larval host plant of swallowtails.
Populus tremuloides Quaking aspen	Salicaceae - Willow Family	Tree, large 20' - 40'	Droopy m & f catkins. April - May	Capsules green to brown with light brown seeds. May - June	Full sun, part shade	Confined to highest mountains in the Trans-Pecos. Prefers ravines & talus slopes above 7000'	Sands, loams, caliche & limestone soils, also igneous soils. Well-drained, mesic.	X	For only those high altitude areas in the Trans-Pecos. Very ornamental. Leaves flutter nervously in the breeze. Has excellent golden yellow fall color, smooth whitish bark reminiscent of beeches in the east. Deciduous.	Catkins and seeds are eaten by a number of species of game & songbirds, especially quail. Twigs, bark & buds are heavily browsed by mule deer, roabbits, squirrels & porcupines.

Populus wislizenii Rio Grande cottonwood (Alamo)	Salicaceae - Willow Family	Tree, large 50' - 90'	Staminate & pistillate catkins. March - July	Capsules, egg-shaped with light brown seeds covered with silky hairs. May - Aug.	Full sun, part shade	Prefers areas along river, streams & irrigation canals in valleys & canyons	Likes deep or rocky alluvial soils; sands, loams, clays; caliche-type soils. Well-drained, mesic.	X	Good overstory, shade producing tree with thick trunk. Rapid grower on moist sites, but fairly short-lived. Some cities don't allow them because of voluminous snow fall in spring. Deciduous.	Leaves occasionally browsed by wildlife. Good protective cover and nesting tree. Cottony catkins used as nest-lining material. A few birds eat the seeds.
Quercus emoryi Emory oak	Fagaceae - Beech Family	Tree, large 30' - 60'	Staminate & pistillate catkins on same tree, yellowish. March - April	Acorns, paired, sessile, every year. June - Sept.	Full sun, part shade	Prefers igneous mountainous regions & canyons in Trans-Pecos. Usually above 5000' in elevation.	Likes deep soils, acid sands & loams, igneous soils. Well-drained, mesic. Likes extra water.	X	A large shrub/tree depending on elevation with black trunk, rounded shape & persistent holly-like leaves arranged in star-shaped clusters. Bark like back of an armadillo. Does well in Alpine & Ft. Davis. Also Panhandle sands. Persistent to Evergreen.	Emory oak acorns & mast are highly sought after by wildlife, both birds & mammals. Serves as an excellent protective cover & nesting tree. Good substrate for insectivorous birds. Birds eat the catkins in the spring.
Quercus gravesii Chisos red oak	Fagaceae - Beech Family	Tree, large 20' - 40'	Inconspicuous staminate & pistillate catkins, reddish. April - May	Acorns. Aug. - Sept.	Full sun, part shade	Prefers mountains, canyons & arroyos in both igneous & limestone substrates in Davis, Guadalupe & Chisos mountains from 1200' to 7600' elevation.	Limestone & igneous soils; sands, loams & clays. Well-drained, mesic.	X	A small or large tree with roughly furrowed, hard black bark & deciduous leaves that turn scarlet in the autumn. Deciduous to Persistent.	The acorns are eaten by various species of ground squirrels & the foliage is sometimes browsed by mule deer. Acorns prized by jays, woodpeckers & gamebirds. Good protective cover & nesting tree. Birds eat catkins in spring. Insectivorous bird substrate.
Quercus muehlenbergii Chinkapin oak	Fagaceae - Beech Family	Tree, large 40' - 60'	Inconspicuous catkins, m & f, cream to yellowish. March - June	Acorns. Sept. - Oct., every two years.	Full sun, part shade	Prefers upland forested areas	Loams, clays & limestone soils. Well-drained, mesic.	X	Beautiful, fast-growing shade tree. Attractive leaf shape. Bronze autumn color. Deciduous.	Sweet, edible nuts favored by many species of birds & mammals, deer, raccoons, opossums & squirrels. Good nesting and cover tree. Good substrate for insectivorous birds. Larval host plant to Horace's Duskywing.
Salix amygdaloides Peach-leaf willow	Salicaceae - Willow Family	Tree, large 30' - 40'	m & f creamy yellowish-green catkins, on separate trees. April -	Capsules, borne on catkins reddish-yellow with numerous seeds. May -	Full sun, part shade	Prefers areas around water ways whether wet or dry, ponds or any other water-holding depression.	Sand, loams & clays; limestone soils. Well-drained but moist.	X X X	A striking willow with yellow twigs, green peach-leaf shaped leaves that are attractively silvery white underneath. Tree has drooping branches. Rapid-growing but not long-lived. Deciduous.	Catkins provide food & nesting material for many forms of wildlife. Good substrate for insectivorous birds. Allows light underneath the tree for other things to grow. LHP for Mourning Cloak.

			May	June														
Sapindus drummondii Western soapberry	Sapindaceae - Soapberry family	Tree, large 15' - 50'	clusters of small white flowers. May - June	Round, amber, wrinkled berry-like fruit with 1 seed. Sept. - Oct.	Full sun, part shade	Prefers moist soils along streams & fencerows, scattered throughout Texas	Sands, loams & clays, likes limestone soils. Well-drained, mesic.	X	X	X	X	X	X	X	X	X	Fine-looking shade tree with dependable yellow fall foliage. Translucent amber fruits have white seeds which are poisonous to us. Moderately fast growing; also tolerates poor sites. Forms thickets but does not live long. Deciduous.	Fruit highly prized by many kinds of birds that are not affected by poison. Bluebirds, robins, cedar waxwings devour them. Small flowers provide nectar to various insects. Good nest & cover tree. Substrate to insectivores. LHP to Soapberry hairstreak.
Diospyros texana Texas persimmon	Ebenaceae - Ebony Family	Tree, small 15' - 40'	Small greenish white flowers, fragrant. March.	Fruit, small, round black & fleshy with lots of seeds. June - July	Full, part shade	Prefers limestone hills, shinnery oak dunes, breaks & rocky canyons, mesquite groves, areas along water courses.	Sands, loams & clays. Well-drained, xeric.	X	X	X	X	X	X	X	X	X	Very attractive tree with smooth gnarled bark. Quite drought-resistant once established. Deciduous.	Fragrant whitish flowers attract insects of many kinds. Ripe fruits eaten by several species of game & song birds. Mammals, especially javalina, relish the fruit. Leaves browsed by white-tailed deer. Larval host plant for Gray hairstreak & Henry's elfin.
Juglans microcarpa Little walnut	Juglandaceae Walnut Family	Tree, small 10' - 30'	Inconspicuous m & f flowers, greenish, on same trees. March - April	Walnut, small. Sept. - Oct.	Full sun, part shade	Prefers rocky areas near streams, arroyos & rocky ravines in Central, South & West Texas.	Loams, clays. Likes rocky limestone soils. Well-drained, mesic.	X	X	X	X	X	X	X	X	X	A man-trunked small tree with a long tap root. Often hybridizes with Arizona walnut. Quite disease resistant. Deciduous.	Produces small walnuts with high-quality meat eaten by rock squirrels & other small mammals. Gamebirds & songbirds also favor nuts. Good nesting & cover tree. Larval host plant of the Banded hairstreak.
Morus microphylla Texas mulberry	Moraceae Fig Family	Tree, small 10' - 25'	Small green to red inconspicuous ament-like spikes. March - April	Mulberries, red to black, 1-seeded drupes in syncarp. May - June	Full sun, part shade	Prefers canyons, limestone & igneous slopes in western 2/3rds of Texas.	Sands, loams, clays, caliche-type & limestone soils. Well-drained, xeric.	X	X	X	X	X	X	X	X	X	A small shaggy tree more often shrub with rough, sand-papery leaves & small fruits. Very drought-tolerant once established. Deciduous.	Texas mulberry makes a good cover & nesting shrub. Several species of game & song birds, as well as opossum, raccoons & squirrels relish the ripe mulberries. Quail, mourning doves & cardinals are especially fond of them. Deer often browse the leaves.

Morus rubra Red mulberry	Moraceae Fig Family	Tree, small 35' - 40'	Inconspicuous m & f greenish flowers. March - June	Mulberry (syncarp of aggregated red-black drupelets). April - Aug.	Full sun, part shade, dappled shade	Prefers rich soils along streams, creek bottoms & moist woodlands	Sands, loams & clays. Well-drained, mesic.	X	X	X	X	X	X	X	X	X	X	X	Handsome understory tree with polymorphic leaves, reddish black fruit and broad spreading crown. Deciduous.	Red mulberries are the prime source of spring fruit for neotropical migrant birds. 21 species devour them as soon as they ripen as do squirrels, raccoons, opossums & skunks. Larval host plant for Mourning Cloak.
Prosopis glandulosa Honey mesquite	Leguminosae Legume Family	Tree, small 20' - 30'	Showy creamy yellow elongated spike-like racemes. May - Sept.	Legumes in loose clusters. Aug. - Sept.	Full sun, part shade	Tolerates wide range of situations, open fields, edges of woodlands, etc.	Sands, loams & clays. Well-drained, xeric.	X	X	X	X	X	X	X	X	X	X	X	Attractive tree with crooked, drooping branches, feathery leaves & rounded crown. Fast growing & often shrubby, forming thickets. Fixes nitrogen in the soil. Deciduous.	Good nectar plant for bees & other insects. Many species of wildlife like quail, bobwhite, doves depend on it for food & shelter from the sun. Squirrels, coyotes, skunks, rabbits & deer eat pods. LHP for Long-tailed skipper & Reickert's blue.
Prunus serotina v. rufula Southwestern black cherry	Rosaceae - Rose Family	Tree, small 25' - 50'	Showy racemes of creamy white flowers. March - April	Cherries, small & black, ripen individually. July - Oct.	Full sun, part shade	Prefers areas near streams, found in canyons & other protected areas.	Deep sands, loams & clays. Well-drained, mesic.	X										Very ornamental overstory tree with attractive bark, pretty leaves & showy flowers & fruit. Has fruit in all stages of ripening on same raceme. Deciduous.	Very important wildlife food source. Flowers attract several species of insects. Ripe cherries eaten by several species of birds & small mammals, esp. rodents, ground squirrels, rabbits. Foliage browsed by deer & rabbits. Good nest & cover tree.	
Quercus arizonica Arizona white oak	Fagaceae - Beech Family	Tree, small 20' - 35'	Inconspicuous staminate & pistillate catkins, yellowish. April - May	Acorns, every year. Sept. - Nov.	Full sun, part shade	Prefers some mountain ranges of the Trans-Pecos. High elevations in El Paso, Culberson & Brewster counties.	Loams, clays, various rocky soils. Well-drained, mesic-xeric.	X										At low elevations a tree, at high elevations a shrub with rounded top & spreading branches with firm, rigid evergreen leaves of bluish-green color. Deciduous.	Acorns & mast highly sought after by woodpeckers, gamebirds, hays & small mammals. Makes a good protective cover & nesting tree. Good substrate for insectivorous birds. Spring catkins eaten by various species of birds in the spring.	
Quercus gambelii Gambel oak	Fagaceae - Beech Family	Tree, small 15' - 25'	Inconspicuous staminate & pistillate catkins. May.	Acorns, every year. Sept. - Oct.	Full sun, part shade	Prefers high elevations, never found lower than 7,500 feet. Found in Chinati, Chisos, Davis & Guadalupe mountains.	Prefers alkaline or acid soils. Well-drained, mesic.	X										An attractive small tree for higher elevations. Cannot tolerate long periods of high heat. Has variable habit & can form dense thickets. Young leaves are brownish gray & very attractively dissected. Deciduous.	Foliage is sometimes browsed by mule deer & porcupine. Sweet acorns are highly prized by birds of several species & also by small mammals. Good protective cover & nesting tree. Good substrate for insectivorous birds.	

Quercus glaucooides Lacey oak	Fagaceae - Beech Family	Tree, small 20' - 30'	Inconspicuous m & f catkins, red & greenish. March - April	Acorns. Sept. - Oct.	Full sun, part shade	Likes deep soils; sands, loams, clays.	Sands, loams & clays, Loves thin limestone, caliche-type soils. Well-drained, xeric.	X		X	A very attractive Texas oak of moderate size. May be multi-trunked. Has dusky blue to blue-gray deciduous leaves and fine golden fall color. Extremely drought tolerant. Can grow on thin, hard limestone rock especially on Edwards Plateau. Deciduous.	Excellent cover & nesting tree. Good substrate for insectivorous birds. Squirrels devour acorns & also nest in tree. Several species of birds also love acorns: turkey, quail, woodpeckers, doves & jays. White-tailed deer also love them.
Quercus grisea Gray oak	Fagaceae - Beech Family	Tree, small 10' - 50'	Inconspicuous staminate & pistillate catkins on same tree. April	Acorns, every year. Sept. - Oct.	Full sun, part shade	Prefers mountainous areas, conyon slopes, wide areas in the Trans-Pecos to 7800' in Chisos, Chinati, Davis, Del orte, Glass, Guadalupe, Hueco & Vieja mountains.	Igneous & limestone soils, prefers acid sands. Well-drained, xeric.	X		X	Sometimes only a shrub on exposed slopes; a small tree on alluvial conyons. Has entire or toothed grayish-green leaves. Deciduous.	Leaves are browsed by mule deer, porcupine, while many species of ground squirrel, rodents & javalina feed on acorns. Gamebirds, jays & woodpeckers eat the acorns. Good cover & nest tree. Good substrate for insectivorous birds. Birds eat catkins.
Quercus mohriana Mohr oak	Fagaceae - Beech Family	Tree, small 10' - 20'	Inconspicuous m & female catkins, reddish. April - May	Acorns, reddish brown, every year. Sept. - Nov.	Full sun, part shade	Prefers limestone hills & mountains, also grasslands, igneous slopes in West & West Central Texas. Often shrubby, creating mottes in the Rolling Plains & western Edwards Plateau.	Sands, loams, hard limestone, exposed caliche like soils. Well-drained, xeric.	X	X	X	One of the few oaks of the midgrass to shortgrass prairies. A small, round-topped evergreen oak with dark green to gray green leaves with wavy edges & furry white underside. Forms thickets, is drought tolerant & fire resistant. Persistent to Evergreen.	Mohr oak is an excellent nesting & protective cover for birds & small mammals. Catkins eaten by several species of birds. Acorns eaten & cached by several kinds of birds & mammals. Good substrate for insectivorous birds.
Quercus pungens v. vaseyana Vasey oak	Fagaceae - Beech Family	Tree, small 25' - 30'	Inconspicuous m & f catkins, reddish on separate trees. March - May	Acorns, every year, solitary or in pairs. Sept. - Oct.	Full sun, part shade	Prefers dry limestone hills & canyon bluffs in desertic mountais, dry arroyos & along creek banks.	Sands, loams & clays. Likes limestone, caliche-type soils. Well-drained, xeric.	X		X	A small very drought-tolerant evergreen oak. Sometimes a shrub. Forms small thickets. May be multi-trunked. Quite cold hardy. Leaves are pleasantly aromatic, lustrous with conspicuous veins. Persistent to Evergreen.	Acorns are eaten by mule deer, raccoons, porcupines, ground squirrels. Provides good nesting site & protective cover for birds. Jays & woodpeckers also eat them. Good substrate for insectivorous birds. Larval host plant to duskywing butterflies.

Rhus lanceolata Lance-leaf sumac	Anacardiaceae Sumac Family	Tree, small 10' - 20'	m & f flowers, small greenish white, on separate trees. June	Drupes, small red, in clusters, remain after leaves fall. Sept. - Dec.	Full sun, part shade	Occurs on limestone & in calcareous soils, woodlands & roadside edges, along fencerows. Tolerates disturbed soils.	Sands, sandy loams, neutral clays, likes limestone soils. Well-drained, mesic.	X	X	X			X	Sometimes thicket-forming small tree with elegant compound leaves and showy red fruit clusters. Only trees with f flowers have fruit. Beautiful red color in the fall. Fast growing with a very attractive shape. Deciduous.	Fruit is eaten by more than 20 species of birds, favored by quail & turkey. Flowers attract numerous insects in spring, good nectar source for bees & butterflies. Leaves browsed by deer. Larval host plant for Red-banded hairstreak.	
Sambucus caerulea Blue elderberry	Caprifoliaceae Honeysuckle Family	Tree, small 10' - 12'	Showy yellowish-white flowers in cymes. April - Aug.	Sweet, juicy blue berries. Aug. - Sept.	Full sun, part shade	Prefers moist areas in canyons, streamsides, talus slopes, at the bases of cliffs at 7000' elevation plus.	Sands, loams, clays, limestone soils. Well-drained, mesic.						X	This very rare plant is only found above 7000'. It has beautiful flowers & sweet edible fruit. Good for erosion control. Grows rapidly, sprouts from base. Deciduous.	Flowers attract myriads of insects. Sweet fruit is highly sought after by 12 species of birds & several small mammals. Foliage browsed by mule deer. Gambel & Scaled quail are especially found of the berries. So is the Ring-necked phaesant.	
Sophora secundiflora Texas mountain-laurel	Leguminosae Legume Family	Tree, small 6' - 30'	Showy, lavender-purple flower clusters, fragrant. March - April	Leguminous pod, brown with red toxic seeds. Oct. - Dec.	Full sun, part shade, dappled shade	Prefers brushy vegetation & caliche cuestas in Edwards Plateau, also on gravelly hills in South Texas, West Texas & Coastal Bend.	Sands, loams & clays. Well-drained, xeric.		X	X			x	Attractive evergreen tree with shiny dark green leathery compound leaves and showy purple flowers that smell a bit like grape Kool Aid. Has excellent ornamental potential. Fairly drought-tolerant and can be grown from seed. Seeds very toxic. Evergreen.	Fragrant flower clusters attract much insect activity in the spring. Leaves are only browsed by white-tailed deer when they are very hungry. Seeds are avoided. This is a good cover & nesting tree, however.	
Acer grandidentatum Big-toothed maple	Aceraceae - Maple Family	Ornamental tree 20' - 50'	Small & yellow, in few-flowered clusters. April - May	Samara, double-winged rose-colored. Sept.	Full sun, part shade	Prefers moist canyons of Edwards Plateau & mountains of Trans Pecos	Sands, loams & clays. Likes limestone soils. Mesic, likes moist soils.	X		X			X	One of the most beautiful ornamental trees in Texas with its beautifully shaped leaves & exquisite fall color. Grows quickly & does very well under cultivation. Deciduous.	White-tailed deer browse the foliage. Samaras used as food by many species of birds & small mammals. In the spring, many species of birds eat the young flowers. Good nesting & cover tree. Excellent substrate for insectivorous birds.	
Acacia farnesiana Huisache	Leguminosae Legume Family	Ornamental small tree 15' - 30'	Showy, yellow round heads, fragrant. Feb. - March	Legume, brownish-black. Aug. - Sept.	Full sun	Prefers open areas, fields, pastures & fence rows	Sands, loams & clays. Moderately well-drained. Seasonal poor drainage O.K.	X	X	X		X	X	X	Medium-sized tree to shrub; densely branched & armed with long paired, straight spines. Rapid growth rate. Profusely flowering in early spring. In southern Texas starts flowering in late Dec. Very fragrant. Fairly drought	Provides quick shade in spring. Good cover & nesting tree esp. for White-winged doves. Good nurse tree to other plants. Small mammals eat the pods. Excellent pollen & nectar source for bees & other insects. Larval host

																		tolerant. Deciduous.	plant for Marine Blue.
Acacia greggii Gregg acacia	Leguminosae Legume Family	Ornamental small tree 5' - 9'	Showy creamy-yellow spikes with exerted stamens. April - Oct., shorther bloom time further north.	Legume, light brown to reddish. July - Dec.	Full sun, part shade	Prefers chaparral & brushy areas in Rio Grande Plains, Trans Pecos & parts of Rolling Plains	Sands, loams, clays, caliche type & limestone soils. Well-drained, xeric.	X						X	X	X	X	Thorny, thicket-forming, round-topped shrub or small tree with delicate compound leaves & creamy yellow flowers. Can form impenetrable thickets in shrub form. Deciduous.	Gregg acacia furnishes cover & shelter for small animals. Flowers attract myriads of insects. Seeds are eaten by bobwhite & scaled quail. White-tailed deer browse foliage. Pollen important bee food. Good honey plant.
Acacia roemeriana Roemer's acacia	Leguminosae Legume Family	Ornamental small tree 5' - 10'	Showy creamy-white flower balls. April - Aug.	Legume, brown. July - Sept.	Full sun, part shade	Prefers chaparral & brushy areas on limestone soils, gravelly bluffs & banks	Sands, loams, clays & limestone soils. Well-drained, xeric.						X	X	X		X	Round-topped, spiny shrub with many spreading branches, bipinnately compound leaves & creamy white ball-like flowers. Deciduous.	Roemer's acacia provides good protective cover & nesting sites for birds. Nectar-laden flowers attract many kinds of insects, especially bees & butterflies.
Acacia wrightii Wright acacia	Leguminosae Legume Family	Ornamental small tree 20' - 30'	Showy creamy-yellow flowers in fuzzy cylindrical spikes. March, May, and after rain.	Legume, broad, light brownish green with dark brown seeds. May - Aug.	Full sun, part shade	Prefers chaparral & woodlands along creeks & canyons	Sands, loams & clays, likes limestone, caliche-type soils. Well-drained, xeric.						X	X	X		X	Spiny shrub or small tree with wide spreading branches & irregular crown. Attractive light yellow bottlebrush-like flowers. Delicate foliage gives light shade, allowing other wildflowers to grow underneath. Fairly cold hardy for an acacia. Evergreen.	Pollen produced by flowers an important food source for bees. Makes an excellent honey tree. Good protective cover & nesting site for birds. Larval host plant for the Marine blue butterfly.
Amelanchier utahensis Utah serviceberry	Rosaceae - Rose Family	Ornamental small tree 16' - 25'	Showy white to pink flowers. April, May, or June, depending on rainfall.	Berries (pomes), bluish-black. Aug. - Sept.	Full sun, part shade	Prefers dry canyons & slopes & mountain sides at 7000', in Guadalupe mountains, Culberson County.	Sands, loams & clays. Well-drained, mesic.										X	This extremely showy ornamental with the white to pink flowers and pretty leaves makes an excellent accent plant in right habitat. Deciduous.	The showy flowers attract myriads of insects of many varieties. Birds & ground squirrels are highly fond of the ripe fruit. Mule deer readily browse the leaves.

Cercis canadensis v. mexicana Mexican redbud	Leguminosae - Legume Family	Ornamental tree 10' - 30'	Showy magenta pea-like flowers. March, before leaves.	Legumes, brownish-red, in clusters. Sept.	Full sun, part shade, dappled shade	Prefers thinner calcareous, rocky soils of Edwards Plateau & North Central Texas.	Sands, loams & clays; likes limestone soils. Well-drained, mesic; but less moisture than Eastern variety.	X	X	X	X			Highly ornamental and showy small tree with spreading, flat or rounded crown. Good understory tree or accent plant. Fast growing, usually with single trunk. Leaves have distinctive kidney shape & are shinier than other subspecies of Redbud. Deciduous.	Beautiful magenta flowers are copious early nectar source for butterflies, moths, bees, etc. Seeds are eaten by a number of species of birds; foliage browsed by white-tailed deer. Larval host plant to Henry's Elfin.
Cercocarpus montanus v. argenteus Mountain mahogany	Rosaceae - Rose Family	Ornamental tree 8' - 15'	White to yellowish flowers. March - June	Brown, leathery fruit, tipped with long white plume. May - Nov.	Full sun, part shade	Prefers rocky slopes & canyons of Edwards Plateau & rocky bluffs of Trans Pecos.	Sands, loams & clays. Likes limestone, caliche-like soils. Well-drained, mesic-xeric.				X		X	Attractive, small ornamental tree. Pretty dark green leaves with dense white wool underneath and stunning fruit give it a very special look. Most beautiful in fall. Especially striking when backlit by the sun. Fairly slow growing. Persistent to Evergreen.	Good cover & nesting tree. The plumes of the fruit used as nesting material. Leaves are browsed by white-tailed & mule deer.
Chilopsis linearis Desert willow	Bignoniaceae - Catalpa Family	Ornamental tree 10' - 15'	Showy pink-magenta trumpet shaped flowers. May - Sept.	Capsule with winged seeds. Aug. - Nov.	Full sun, part shade	Prefers dry washes & gravelly creek beds, arroyos & water courses.	Sands, loams & clays. Well-drained, mesic-xeric.			X	X		X	Fast-growing, ornamental tree with attractive willow-like leaves & showy tubular flowers. Can be quite winter hardy. Is a phreatophyte which will extend its roots deep down to the water table. Does not like to be overwatered in cultivation. Deciduous.	Both insects & hummingbirds are attracted to the flowers. Orioles & tanagers will also feed on the flowers. Various species of birds forage on the winged seeds.
Eysenhardtia texana Texas kidneywood	Leguminosae - Legume Family	Ornamental tree 6' - 15'	Showy racemes of white flowers, fragrant. April - Nov., especially after rains.	Pods, small & linear. July - Sept.	Full sun, part shade	Prefers chaparral & brushy areas on calcareous soils	Sands, loams & clays. Well-drained, xeric.	X				X	X	Irregularly-shaped spineless shrub with aromatic compound leaves giving the shrub an airy appearance. Flowers can be profuse. Quick-growing & very drought tolerant. Deciduous.	Sweet-scented flowers attract myriads of insects: bees, butterflies, diurnal moths. Leaves are heavily browsed by deer. Seeds occasionally consumed by birds. Larval host plant for the Dogface butterfly.

Guaiacum angustifolia Guayacan	Zygophyllaceae Caltrop Family	Ornamental small tree 10' - 20'	Showy purple flowers with yellow anthers. March, April, off and on to Sept., depending on rain.	Capsules, brown with 1-3 orange seeds. Sept.	Full sun, part shade	Prefers brushy areas & open flats. Can be found on well-drained sites on the Coastal Bend.	Sands, loams & clays. Likes limestone soils. Well-drained, xeric.	X						X	X		X	Highly attractive & unusual small tree with compact branches, tiny compound leaves & purple flower clusters. Tree has a very distinctive and eye-catching habit. Often grows in clumps with branches appearing thick, black & stubby. Evergreen.	The purple & yellow flowers attract several kinds of insects. Excellent honey plant. Good nest tree. Leaves are highly nutritious browse for white-tailed deer. Arils eaten by several species of birds & small mammals. LHP of Gray & Lyside hairstreaks.
Leucaena retusa Goldenball leadtree	Leguminosae - Legume Family	Ornamental tree 12' - 25'	Showy yellow flower balls, very fragrant. April - Oct.	Leguminous pod, linear. Sept. - Nov.	Full sun, part shade	Prefers dry rocky canyons on rocky soils	Sands, loams & clays; prefers limestone, caliche-type soils. Well-drained, xeric.							X			X	Airy ornamental with bright green twice compound leaves and profusely blooming yellow ball-like blossoms. Flaking bark is cinnamon-colored & very attractive. Tree blooms from spring until fall. Sun-loving flowers are able to grow underneath. Deciduous.	Excellent cover & nesting tree. Insects of many varieties are attracted to the copious nectar of the fragrant flowers. White-tailed deer browse the leaves.
Parkinsonia aculeata Retama	Leguminosae - Legume Family	Ornamental tree 9' - 30'	Showy yellow flowers, fragrant. April - July	Leguminous, linear orange to brown, with greenish brown seeds. Aug. - Oct.	Full sun, part shade	Prefers low, poorly drained areas, also on a variety of other sites.	Sands, loams & clays. Mesic, poor drainage O.K.	X						X	X		X	A thorny, green-barked shrub with graceful drooping branches and rounded crown. Flowers are a fragrant bright yellow. Leaves are small & delicate, giving a light airy appearance. Almost always in bloom. Tolerates salt. Can become weedy. Deciduous.	Flower nectar attracts myriads of insects. Deer occasionally browse the leaves. Pods are also eaten. Seeds are relished by doves, bobwhite quail & other species of birds & small mammals. Good nesting site & cover tree for several bird species.
Prosopis pubescens Screwbean mesquite	Leguminosae - Legume Family	Ornamental tree 10' - 30'	Showy cream or greenish-white cylindrical spikes. May - June	Legumes shaped like corkscrew, hairy at first. July - Aug.	Full sun, part shade	Prefers arroyos, washes & larger tributaries & deltas along Rio Grande in West Texas.	Sands & loams. Well-drained, mesic.							X			X	Screwbean mesquite is absolutely dazzling when in bloom. Blossoms vary in color from a rich yellowy cream to white. Foliage is lacy & thorns are small. Grows only where water table is near to the surface or where lots of run-off is available. Deciduous.	Fragrant flowers attract myriads of insects. Many mammals will eat the seeds of the screwbeans. Roadrunners, Gambel & Montezuma quail are especially fond of them.

Robinia neomexicana New Mexico locust	Leguminosae - Legume Family	Ornamental tree 10' - 25'	Showy rose-colored flower clusters. April - Aug.	Legumes with seeds. Sept. - Oct.	Full sun, part shade	Found only in the Guadalupe mountains at 5-8000' in pine-oak & ponderosa pine-Douglas fir associations. Prefers moist soils along streams.	Sands, loams & clays. Well-drained, mesic.									X	Can be used as an understory ornamental tree. This spiny small tree will form thickets. It has very attractive compound leaves & gorgeous rose-colored flowers. Good erosion control plant. Deciduous.	Flowers attract several varieties of insects. Leaves are browsed by mule deer. Fruit is eaten by gambel's quail, mountain sheep, mule deer, porcupines & ground squirrels.
Ungnadia speciosa Mexican buckeye	Sapindaceae - Soapberry Family	Ornamental tree or large shrub 15' - 30'	Showy clusters of pink-magenta flowers cloak branches, before leaves come out. Fragrant. March - May	Capsules (tripartite leathery "buckeyes"), brown-black. Oct. - Nov.	Full sun, part shade	Prefers rocky areas in canyons, slopes & ridges & along fencerows.	Sands, loams & clays. Well-drained, mesic.	X	X	X	X	X	X			X	Showy, small, shrubby often multi-trunked ornamental with irregular shape. Spectacular pink blossoms in spring. Good understory tree, prefers at least half a day in sun. Has pretty yellow fall color also. Deciduous.	Splashy pink flowers are a good nectar source for bees, butterflies, diurnal moths. Good honey plant. Sweet seeds eaten by a few species of birds and mammals, though poisonous to humans. Larval host plant for Henry's Elf.
Vauquelinia angustifolia Chisos rosewood	Rosaceae - Rose Family	Ornamental small tree 10' - 30'	Showy white flowers in clusters, fragrant. June - Aug.	Follicle, densely hairy. Aug. - Oct.	Full sun, part shade	Found scattered in canyons & along rocky slopes & chaparral in Chisos, Dead Horse mountains in the Trans-Pecos from 5300 - 6500'.	Acid sands, loams, also clays. Well-drained, mesic-xeric.									X	Small ornamental evergreen tree with narrow toothed leaves & many small greenish-white flower clusters. Can be used as a dense screen. Is fairly cold-hardy. Does not appreciate very hot summers. Deciduous.	Fruits are eaten by birds if other fruits are not available. Best as a protective cover & nesting tree. Leaves are browsed by mule deer.
Cupressus arizonica Arizona cypress	Cupressaceae Cypress Family	Conifer 30' - 75'	Inconspicuous staminate & pistillate, on different twigs. April - May	Staminate cones, subglobose dry & woody. Sept. - Oct.	Full sun	Prefers high canyons, gravelly slopes or cuts on north exposure, especially in Chisos mountains from 3000 - 8000'.	Sands, loams & clays. Well-drained, mesic, but tolerates arid conditions.									X	Highly ornamental evergreen with pretty grayish blue-green foliage. Widely used in landscapes as an ornamental. Fast growing, but rather short-lived. Aromatic foliage & very attractive trunk. Not as pretty in areas with hot summers. Evergreen.	Arizona cypress provides excellent protective cover & a good nesting tree for birds.
Juniperus deppeana Alligator juniper	Cupressaceae Cypress Family	Conifer 15' - 25'	Inconspicuous staminate & pistillate, on separate trees. Jan. -	Berry-like cones maturing in second year. Sept. - Dec.	Full sun	Prefers oak zones in mountainous regions in Trans-Pecos. Likes open rocky areas	Sands, loams, clays, limestone soils. Well-drained, xeric.									X	Most abundant juniper in the Davis mountains. It is highly ornamental with distinctive checkered bark resembling the skin of an	Excellent protective cover & nesting tree. Leaves browsed by mule deer. Fruit eaten by gray fox, rock squirrels, wild turkey & other wildlife species.

			March			& foothills of Davis, Guadalupe, Chisos, Sierra Vieja, Chinati & Eagle mountains.								alligator's back. Has a long thick trunk. Branches don't grow to the ground. Fast growing & adaptable out of range. Evergreen.	
Juniperus flaccida Weeping juniper	Cupressaceae Cypress Family	Conifer 20' - 30'	Inconspicuous, staminate & pistillate. April - May	Berry-like cones, mature in second season. Sept. - Oct.	Full sun, part shade	Prefers forested or open rocky slopes of the Chisos Mountains in the Trans-Pecos at elevations of 4000 - 8000'.	Sands, loams, clays, acid or calcareous soils, also igneous. Well-drained, mesic.						X	Evergreen shrub or tree with distinctive attractive droopy branchlets which give the tree a wilted appearance. Trunk is also distinctive with reddish brown, deeply furrowed shredding bark. Highly ornamental & good accent plant. Slow-growing. Evergreen.	This long-lived, winter-hardy tree provides excellent protective cover & good nesting sites for birds. Berry-like cones are eaten by a number of birds & small mammals.
Juniperus pinchotii Pinchot juniper	Cupressaceae Cypress Family	Conifer 10' - 25'	Inconspicuous Feb.	Cones, red & berry-like, matures within a year. March	Full sun, part shade	Prefers dry hillsides & canyons of western Texas on open flats in sand & caprocked mesas.	Sands, loams & clays. Likes limestone or gypsum soils. Well-drained, mesic.	X		X	X			Scraggly red-berried juniper good for reforestation burned out areas. Often forms thickets of excellent ground cover. Good for erosion control. Evergreen.	Several species of birds & small mammals dine on the berries. Makes an excellent place to build a nest or to escape from predators. Larval host plant of the Juniper hairstreak.
Juniperus scopulorum Rocky Mountain juniper	Cupressaceae Cypress Family	Conifer 20' - 36'	Inconspicuous, small yellowish m & f cones. April - May	Bluish berry-like fruit takes 2 years to ripen. Nov. - Dec.	Full sun, part shade	Prefers rocky areas in canyons & on breaks in Trans Pecos Guadalupe Mountains & Northern Plains.	Sands, loams, clays & caliche-type soils. Well-drained, mesic-xeric.				X	X	X	Large or shrubby evergreen with a short, stout trunk that branches out close to the ground. Has smooth, fibrous, shredding bark. Fruits take 2 years to ripen. Evergreen.	This is an excellent protective cover and nesting tree. Many species of birds & small mammals eat the berry-like fruit. Provides good food late in season. Larval host plant for the Olive hairstreak.
Pinus cembroides Mexican pinyon pine	Pinaceae - Pine Family	Conifer 20' - 50'	Inconspicuous. April - May	Cones. Aug. - Sept.	Full sun	Prefers higher elevations from 4000 - 8000' on rocky slopes of West Texas mountains.	Sands, loams & clays, likes limestone & caliche-like soils. Well-drained, xeric.						X	Very attractive pine with gnarled trunk. Flexible blue-green needles are highly attractive. Makes a great accent plant. Not very heat tolerant, but fairly drought-tolerant. Fairly slow growing. Evergreen.	Excellent nesting & cover tree throughout the year. Pinyon nuts are highly prized by both gamebirds like quail & turkey & others able to extract them, i.e., scrub jays, woodpeckers & finches. Ground squirrels, rock squirrels, porcupines also love them.

Pinus edulis Colorado pinyon pine	Pinaceae - Pine Family	Conifer 10' - 20'	Inconspicuous. April - May	Cones. Aug. - Sept.	Full sun	Prefers mountainous slopes in the Guadalupe Mountains	Sands, loams & clays. Well-drained, xeric.	X	Attractive conifer with rounded or pyramidal shape with leaves thickly covering twigs. Very drought-tolerant. Has picturesque gnarled trunk. Makes an excellent accent plant. Fairly cold-tolerant. Evergreen.	Colorado pinyon pine makes a good nesting & cover tree. Seeds are eaten by a number of species of small mammals, gamebirds, woodpeckers, jays, quail & turkey.
Pinus ponderosa v. scopulorum Rocky Mountain ponderosa pine	Pinaceae - Pine Family	Conifer 60' - 70'	Inconspicuous yellowish staminate & dark red pistillate. April - June	Cones, ovoid with seeds. Aug. - Sept.	Full sun	Prefers mountain slopes at higher elevations Found in Davis, Guadalupe & Chisos Mountains at elevations above 3000'.	Sands, loams, clays & limestone soils. Well-drained, mesic.	X	Magnificent evergreen with stout branches, thick, somewhat drooping but up-curved (at tip) branches. Crown is rounded or flat. Prefers cool micro climate & a little extra moisture. Fire resistant. Can be used as shelter belt planting. Evergreen.	Excellent protective cover & nesting tree. Seeds of this pine are eaten by several species of birds & mammals including quail, porcupine, rock squirrels, etc. Also browsed by mule deer & mountain sheep. Excellent insect substrate for woodpeckers.
Pinus remota Remote pinyon pine	Pinaceae - Pine Family	Conifer 20' - 30'	Inconspicuous Feb.	Cones. Sept. - Oct.	Full sun, part shade	Prefers rocky mesas & dry limestone slopes of western Edwards Plateau.	Sands, loams & clays, likes limestone & caliche-like soils. Well-drained, xeric.	X	Very attractive pine with pyramidal shape. Flexible blue-green needles are highly appealing. Makes a great accent plant. Very heat tolerant. Evergreen.	Excellent nesting & cover tree throughout the year. Pinyon nuts are highly prized by both gamebirds like quail & turkey & others able to extract them, i.e., scrub jays, woodpeckers & finches. Ground squirrels, rock squirrels, porcupines also love them.
Pinus strobiformis Southwestern white pine (Limber pine)	Pinaceae - Pine Family	Conifer 40' - 60'	Inconspicuous, red staminate cones & reddish purple pistillate scales. June	Cones Good crop every 3 years. Sept. - Oct.	Full sun	Found in small scattered stands, deep canyons, high ridges & rocky foothills at higher elevations in Davis & Guadalupe Mountains from 5000' - 8000'.	Sands, loams, clays & limestone soils. Well-drained, xeric.	X	Highly attractive pine with bluish-green foliage & cones over 6" long. Branches are plume-like & droopy. Slow-growing & long-lived. Good erosion control planting. Evergreen.	Seeds from the cones are eaten by many species of small mammals, gamebirds & larger passerine birds. This makes an excellent protective cover & nesting tree. Good insect substrate for woodpeckers.
Pseudotsuga menziesii Blue Douglas fir	Pinaceae - Pine Family	Conifer 15' - 25'	Inconspicuous, staminate & pistillate cones. May - July	Cones, ovoid & dark reddish brown. Aug. - Sept.	Full sun, part shade	Common in upper canyons & slopes of Guadalupe & Chisos Mountains from 6000' - 8000'	Sands, sandy loams, limestone or igneous soils. Well-drained, mesic.	X	Attractive evergreen with compact habit & palish blue-green leaves. Trees are straight & tall, leaves are linear & flat, elongate & pendulous. Branches can grow all the way to the ground. Requires more	Blue Douglas fir makes an excellent protective cover & nesting tree. Seeds are readily eaten by many species of small mammals, gamebirds, woodpeckers & jays.

Berberis haematocarpa Red barbery	Berberidaceae Barbery Family	Shrub 3' - 12'	Showy racemes of yellow flowers. March - May	Berries, deep red. May - Aug.	Full sun, part shade	Prefers higher desert grasslands & canyons in West Texas from 4600' - 7200' in elevation.	Sands, loams & clays. Well-drained, xeric.	X	Highly attractive spiny-leaved shrub with snappy red berries. Flowers are also highly attractive in the spring. Can be used as a ground cover. Or it can serve as a hedge. Evergreen.	Flowers attract many insects such as bees, butterflies, diurnal moths. Fruits are also sought after by many species of game & songbirds. Makes a good cover & nesting plant for small birds due to thorns.
Bouvardia ternifolia Trompetillo	Rubiaceae - Madder Family	Shrub 2' - 4'	Clusters of showy red tubular flowers. May - Nov.	Capsules. July - Dec.	Full sun, part shade	Prefers rocky habitats, usually in mountains or canyons, 3500' - 7300'.	Sands, loams & gravelly clays. Also igneous soils. Well-drained, mesic-xeric.	X	This is a gorgeous ornamental with brilliant clusters of bright red flowers suitable as a border plant. It is also good in a pot or container in the winter to be put inside when the weather gets very cold. Deciduous.	Trompetillo is a premiere hummingbird plant. Leaves are also browsed by mule deer.
Buddleia marrubifolia Butterfly bush	Buddleiaceae Buddleia Family	Shrub 3' - 5'	Densely woolly-white flower clusters with yellow-orange blossoms. June - Oct.	Capsules with numerous small seeds. Aug. - Nov.	Full sun, part shade	Prefers limestone soils of the foothills & arroyos in desertic mountains of west Texas from 1800' - 3800'.	Sands, loams & clays, especially limestone substrates. Well-drained, xeric.	X	This is a gorgeous ornamental shrub with fuzzy, pale gray-green leaves & small orange-red lantana-like flowers. Not very cold-tolerant. Blooms profusely for a long time. Deciduous.	Butterfly bush is highly attractive shrub that attracts myriads of butterflies for much of the summer, as its name implies. Deer & antelope will browse readily on the leaves.
Cephalanthus occidentalis Buttonbush	Rubiaceae - Madder Family	Shrub 5' - 20'	Showy, creamy white round heads. June - Sept.	Capsule clusters, round & dark brown. Aug. - Nov.	Full sun, part shade	Prefers moist soils near swamps, ponds, along streams & stream margins.	Sands, loams, clays. Likes limestone soils. Mesic/hydric. Moderate to high moisture. Seasonally poor drainage O.K.	X X X X X X X X X X X X X X X X	Shrub or small tree growing in low areas, often with swollen base. Leaves opposite & whorled, variously shaped. Bright yellow anthers around white flower balls create a halo effect. Highly ornamental. Suitable for bog or pond area. Deciduous.	Flowers attract hordes of bees, butterflies & other insects. Fruits are highly favored by more than 25 species of birds, including waterfowl, cardinals, finches, sparrows, etc.
Choisya dumosa Star-leaf Mexican orange	Rutaceae - Rue Family	Shrub 1' - 6'	Showy white flowers in cluster of 2 to 4, fragrant. June - Nov.	Follicles, green to brown. Aug. - Dec.	Full sun, part shade	Grows in pinyon belt of Davis & Guadalupe mountains on limestone & igneous formations. Prefers canyons & mountain	Sands, loams & limestone soils, will also grow on igneous soils. Well-drained, mesic-xeric.	X	Gorgeous low aromatic shrub, much branched with distinctive yellow-green palmate leaves in the shape of a star. Highly ornamental & quite a conversation piece. Persistent.	Star-leaf provides good protective cover & nesting substrate for small birds. Flowers attract a wide assortment of insects.

						slopes.							
Chrysanthemum a mexicana Damianita	Asteraceae - Sunflower Family	Shrub 1' - 2'	Showy yellow daisy- like flowers. May - Oct.	Achenes. July - Nov.	Full sun, part shade	Prefers rocky limestone outcrops of ridges, hills & mountians. Also thrives on igneous substrates from 1800' - 7000'.	Prefers rocky limestone soils, also igneous soils. Sands, loams & clays O.K. Well-drained, xeric.	X			X	Highly ornamental aromatic shrub with profusely blooming daisy like flowers. Plant looks rather like a gnarled bonsai plant in dry habitats. Low-growing & long-blooming. Good as an undershrub in a rock garden. Evergreen.	Flower attract several sorts of insects, especially bees. Achenes are eaten by several species of granivorous birds. Deer do not eat this shrub at all.
Dalea bicolor v. argyraea Silver dalea	Leguminosa e - Legume Family	Shrub 1' - 3'	Showy yellow & purple banner-type flowers on spikes, fragrant. July - Oct.	Leguminous pod, small, with seeds. Aug. - Nov.	Full sun	Prefers rocky, dry limestone hills and slopes, also found in outwash, gravelly areas.	Sands, loams & clays; likes limestone soils. Well-drained, xeric.				X	An erect shrub with pompound leaves, attractive bicolored flowers, very attractive if done in a mass planting. Leaves are attractively fuzzy & appear silery in angled light. Flowers are very fragrant. Deciduous.	Flowers are an excellent nectar source for bees & many other kinds of insects. Good cover for small animals. Young leaves are browsed by mule deer & jackrabbits. Leaves are toxic to some domestic livestock. Larval host plant of sulphur butterflies.
Ephedra torreyana Torrey joint-fir	Ephedracea e - Ephedra Family	Shrub 2' - 3'	Inconspicuo us staminate spikes. April	Female cones brownish with paired seeds. May - June	Full sun, part shade	Prefers gypseous & saline desertic habitats in sandy or rocky substrates at elevations of 2000' 6000'.	Sands, loams, clays; tolerates saline & gypseous soils. Well- drained, xeric.				X	Interesting slender-jointed shrub that forms clumps usually under another thorny tree or shrub. Sometimes hard to grow, but worth it. Branches are evergreen with tiny scale leaves. Female plants have red berries. Don't overwater. Evergreen.	Birds will forage on the red berries. Deer love to browse on this plant so you might want to hide it under something thorny. Berry-like cones eaten by quail & turkey.
Ericameria laricifolia Larch- leaf goldenwee d	Asteraceae - Sunflower Family	Shrub 1' - 3'	Showy yellow flower heads. Aug. - Nov.	Achenes. Sept. - Dec.	Full sun, part shade	Prefers canyons & slopes of desertic mountains at elevations of 4200' - 5100'.	Sands, loams & clays. Well- drained, xeric.				X	Much-branched, resinous aromatic shrub with yellow flowers & numerous small leaves emitting a tart lemony scent. Goldenweeds, as their name implies, turn golden in the fall. Evergreen.	Jackrabbits love to browse on this plant even though the leaves smell slightly like lemony turpentine when crushed. Achenes are eaten by several species of seed- eating birds. Insects are attracted to the flowers.

Euphorbia antisyphilitica Candelilla	Euphorbiaceae Euphorbia Family	Shrubby perennial 1' - 3'	Inconspicuous white & brown flowers. May - Oct.	Capsules. July - Nov.	Full sun, part shade	Prefers rocky or gravelly slopes, ridges & hills, usually on limestone substrates from 1100' - 3800' in elevation.	Sands, loams & clays. Well- drained, xeric.			X	Forms grayish clumps of stems topped with unusual flowers. Stems are wand- like, fleshy or rubbery with waxy coating. This makes an interesting accent planting in a desert garden. Not cold-hardy, but good in a pot. Evergreen.	Several species of insects are attracted to the flowers.
Eurotia lanata Winter fat	Chenopodiaceae Goosefoot Family	Shrub 1' - 3'	Small greenish m & f flowers on same plant. April - Aug.	Showy fruit, a silvery white utricle with dense furry tufts. Aug. - Oct.	Full sun, part shade	Prefers dry sub- alkaline soils of mesas & plains from 2000 - 8000' in elevation in western Texas, the High Plains & Trans Pecos.	Sands, loams, clays, caliche- type & limestone soils. Well- drained, xeric.	X	X	X	Highly ornamental & gorgeous shrub in full fruit is back-lit by the sun. Sports fuzzy pale bluish-green leaves & beautiful silvery white fruit. Good plant for erosion control. Highly drought-tolerant once established. Persistent to Evergreen.	Plants only 1 year old bear highly nutritious seeds. Provides excellent forage for mule deer & elk, also for rabbits.
Fallugia paradoxa Apache plume	Rosaceae - Rose Family	Shrub 2' - 10'	Fragile white rose-like flowers appearing with plumes. May - Dec.	Reddish- silver tinged achenes are plumose & borne in fluffy clusters. June - Dec.	Full sun, part shade	Prefers dry arroyos of deserts & foothills from 3000' - 8000' in elevation.	Sands, loams & clays, prefers limestone base. Well-drained, xeric.	X			Straggling, clump-forming shrub with striking pink feathery plumes. Flowers & fruit give great color most of the year. Good erosion control plant. Very drought & heat tolerant. Also is winter-hardy. Persistent to Evergreen.	Flowers attract myriads of insects of all varieties. Makes a good protective cover & nesting shrub. Plumed achenes are used as nesting material by bird building cup nests. Leaves lightly browsed by mule deer.
Fouquieria splendens Ocotillo	Fouquieriaceae Ocotillo Family	Shrub 12' - 25'	Orange-red tubular flowers arranged in spikes. May - July	Capsules, ovoid, with numerous winged seeds. July - Sept.	Full sun, part shade	Prefers dry desert habitats throughout the Trans-Pecos	Sands, sandy loams, either limestone or igneous based. Well- drained, xeric.	X			Marvelously dramatic accent plant, resembling a coachwhip tipped in red & coated with green leaves after rains. Plant is leafless during droughty periods. Has thorns. Can form a screen if planted close together. Evergreen.	This is a spectacular hummingbird plant. Nectar is also coveted by several varieties of insects, especially carpenter bees. Seeds eaten by granivorous birds & small mammals.
Larrea tridentata Creosote bush	Zygophyllaceae Caltrop Family	Shrub 4' - 10'	Showy yellow flowers, 1/2" across. May - Sept., sometimes all year.	Capsules, small & rounded, woolly with white to reddish hairs. July - Oct.	Full sun, part shade	Prefers alluvial hard pan sils of Chihuahuan Desert region	Sands, loams & clays (hard pan). Well-drained, xeric.	X			Dark green aromatic shrub with beautiful yellow flowers & unusual whitish fruits. Drought-tolerant. There are no thorns & it can be pruned into desired shape. Refreshing fragrance. Long- lived. Other plants have a hard time growing	Insects of several varieties are attracted to the yellow flowers. This makes an excellent protective cover & nesting shrub. Leaves are consumed by various small mammals & antelope. Birds eat the flower buds.

Mimosa borealis Fragrant mimosa	Leguminosae - Legume Family	Shrub 2' - 6'	Showy pink ball-like flowers, fragrant. April - July	Leguminous pod, clawed. June - Sept.	Full sun, part shade	Prefers brushy vegetation in Texas Hill Country and West Texas.	Sands, loams, clays, caliche-type & limestone soils. Well-drained, xeric.		X			X	Highly drought-tolerant, showy, long-blooming shrub. Looks very pretty in rock gardens. Makes a great accent shrub. Deciduous.	Pink flower puffs attract several kinds of insects. This is a good protective cover shrub with its small thorns. Leaves are browsed by white-tailed deer.		
Rhus aromatica Fragrant sumac	Anacardiaceae Sumac Family	Shrub 3' - 8'	Inconspicuous yellow flowers appearing before leaves. Feb. - March	Berries, red. May - June	Full sun, part shade, dappled shade.	Prefers limestone outcrops, rocky slopes, prairies, & mesquite plains.	Sands, loams & clays. Likes limestone soils. Well-drained, mesic.	X	X	X	X	X	X	X	Aromatic shrub with pretty leaves & early flowers. Tends to form thickets & is irregularly branched. Deciduous.	Early flowers provide early nectar source for insects like bees, butterflies & moths. The red berries are one of the earliest summer fruits making it popular with several species of birds & small mammals. Larval host plant to Red-banded hairstreak.
Rhus microphylla A Little-leaf sumac	Anacardiaceae Sumac Family	Shrub 4' - 15'	Greenish-white in 2-4" clusters. April - May	Drupes, reddish-orange & hairy. May - June	Full sun, part shade	Prefers dry rocky hillsides or gravelly mesas at altitude of 2000 - 6000'. In western 3/4 of Texas.	Sands, loams, clays, caliche-type & limestone soils. Well-drained, xeric.	X	X	X	X	X	Clump-forming, intricately branched shrub that can get very wide. It is important to space it accordingly from 8 - 20' apart. Bright orange fruits are attractive and persistent. Very drought-tolerant shrub. Deciduous.	Bright orange fruits are highly sought after by several species of birds. Though they are sour, rock squirrels & other small mammals will eat them also. Leaves are sometimes browsed by mule & white-tailed deer, but not much.		
Salvia ballotaeflora Shrubby blue sage	Lamiaceae - Mint Family	Shrub 3' - 6'	Bluish to purplish flowers. Oct.	Fruiting calyx folded with 4 nutlets. March - Nov.	Full sun, part shade	Prefers rocky limestone canyons & slopes & hillsides from 1200' - 2400'.	Sands, loams & clays, prefers limestone substrates. Well-drained, xeric.		X			X	Highly aromatic, much-branched shrub with attractive leaves & bluish flowers. Deciduous to Persistent.	Flowers attract many varieties of insects, especially bees. Nutlets are eaten by small rodents. Shrub provides excellent cover. Leaves are not heavily browsed by mule deer or other mammals.		
Salvia greggii Autumn sage	Lamiaceae - Mint Family	Shrub 2' - 4'	Showy magenta red flowers, also cones in white, pink or coral. April - Dec.	Nutlets. June - Dec.	Full sun, part shade	Prefers rocky soils in central, south & west Texas.	Sands, loams & clays. Likes limestone soils, esp. Well-drained, mesic-xeric.	X		X	X	X	Aromatic showy shrub which blooms prolifically spring, summer & fall. Adaptable to other areas of the state where not native. Good as ground cover or hedge. Really needs good drainage. Persistent (almost evergreen).	Abundant flowers provide copious nectar which is attractive to bees & especially hummingbirds. Ruby-throats can't seem to get enough. Provides food over the long hot summer for them when other plants have waned.		

Salvia regla Mountain sage	Lamiaceae - Mint Family	Shrub 2' - 6'	Showy orange-red tubular flowers. June - Sept. mostly in fall.	Calyx-tube with 4 nutlets nestled at the bottom. Aug. - Nov.	Part shade, dappled shade	Prefers rocky, wooded slopes & canyons of Chisos Mountains	Sands, loams, clays, slightly acid to slightly alkaline. Well-drained, mesic-xeric.	X										X	Showy shrub of West Texas Mountains, highly suitable as ornamental. Mountain sage has glossy aromatic heart-shaped leaves & stays in bloom over long periods. Very drought tolerant once established although does better if not put in direct sun. Deciduous.	The red tubular blooms of this species coincide with the timing of the migrating hummingbirds that pass through the west Texas mountains. Hummingbirds flock to this plant for its copious nectar.
Schaeferl a cuneifolia Desert yaupon	Celastracea e Staff tree Family	Shrub 3' - 6'	Small greenish flowers. Feb. - Sept.	Red to orange showy berries (drupes). July - Nov.	Full sun, part shade	Prefers rocky hillsides, chaparral or xeric sites near coast	Sands, loams, clays. Well- drained, xeric.	X										X	Densely-branched, rigid ornamental shrub with beautiful red berries on female plant. Twigs are somewhat spiny. Evergreen.	Leaves are frequently browsed by white-tailed deer & fruits are a favorite of several species of birds & small mammals. Quail, wrens, coyotes & woodrats are especially fond of them. Birds use tree as nesting & cover site.
Senna wislizenii Canyon senna	Leguminosa e Legume Family	Shrub 4' - 10'	Showy golden yellow flowers in 6" clusters. May - July	Leguminous pods. July - Aug.	Full sun, part shade	Prefers igneous soils in Chihuahuan desert scrub habitats at elevations of 3000' - 4000'.	Sands & loams, also clays, acid or calcareous. Well-drained, xeric.	X										X	This gorgeous shrub sports showy yellow flower clusters & has gracefully arching stems. it blooms all summer. Deciduous.	Flowers attract several varieties of insects, especially bees & butterflies. Shrub provides good protective cover. Seeds are eaten by a few small mammals.
Tecoma stans Yellow trumpets	Bignoniacea e Catalpa Family	Shrub 3' - 6'	Showy yellow tubular flowers in clusters. April - Nov.	Capsules with winged seeds. June - Dec.	Full sun, part shade	Prefers rocky bluffs, sloes & canyons in desertic mountains of south Trans- Pecos form 2000' - 5200' in elevation.	Sands, loams, prefers limestone substrates. Well- drained, xeric.						X					X	Extremely ornamental shrub with showy yellow trumpet- shaped flowers. Attractive green compound leaves. Excellent plant for a rock garden or as an accent plant. Blooms off & on all season. Not too winter hardy, needs a protected area of garden. Deciduous.	Flowers attract myriads of insects. Excellent bee plant. Hummers will also come to these flowers. Leaves and flowers are browsed by several small animals. Seeds are eaten by a few small mammals. Larval host plant of Dogface butterfly.
Tiquilia greggii Plume coldenia	Boraginacea e Borage Family	Shrub 1' - 2'	Hot pink, magenta to purple flowers nestled in whitish gray leaves. June - Oct.	Nutlets, dry & ovate. Aug.- Nov.	Full sun	Prefers limestone habitats of desertic mountains, slopes & flats, rocky hillsides & ravines from 2000' - 4200'.	Prefers calcareous soils & limestone substrates. Well-drained, xeric.	X										X	Absolutely beautiful small gray-leaved shrub with several small magenta flowers peeking out from woolly spherical flower clusters. A great border plant. Good in small desert rock garden. Deciduous.	Flowers attract insects of several varieties. Nutlets are eaten by a few species of rodents & other small mammals.

Viguiera stenoloba Skeleton-leaf golden-eye	Asteraceae - Sunflower Family	Shrub 2' - 4'	Showy yellow daisy-like flowers. May - Nov.	Achenes. July - Dec.	Full sun, part shade	Prefers limestone substrates in various habitats in west Texas	Sands, loams, clays, especially limestone soils. Well-drained, xeric.	X	X				X	Showy clumps of yellow flowers work well in desert garden. Flowers bloom for long periods. Very drought-tolerant & winter hardy. Deciduous to evergreen.	Flowers attract many kinds of insects including butterflies, bees, diurnal moths & flies. Leaves are lightly browsed by mule deer during stress periods. Provides good protective cover & nesting substrate for small birds. Achenes eaten by seed-eating birds	
Agave neomexicana New Mexico century plant	Agavaceae - Agave Family	Succulent leaves 2' - 3', flower stalk 8' - 15'	Showy yellowish panicles on tall scape. June - Aug., blooms only once in its lifetime.	Capsules, elliptical with seeds	Full sun	Prefers rocky slopes & grasslands in Franklin Mountains in El Paso County, also in Guadalupe Mountains in Culberson County	Sands & loams. Well-drained, xeric.						X	An attractive stemless fiber plant with grayish basally clustered leaves forming almost globose rosettes. Cultivated mainly for the beauty of the basal rosette leaves. Evergreen.	When it finally blooms, flowers are highly attractive to insects and hummingbirds, as well as nectarivorous bats. Ripe seeds eaten by several species of small mammals & gamebirds.	
Hechtia texensis Texas false agave	Bromeliaceae - Pineapple Family	Succulent 2' - 4'	Small unisexual flowers on stalk. Feb. - May	Capsules, ovate with oblong, narrowly winged seeds. May - Aug.	Full sun	Prefers canyons & rocky areas & limestone mesas, ridges & slopes especially in Big Bend area.	Prefers limestone soils. Well-drained, xeric.						X	Highly ornamental succulent of Pineapple family with attractive yellowish-green leaves that turn reddish in the fall. The basal rosette of leaves make this plant a great accent plant in proper habitat. Evergreen.	Several small mammals eat the ripened seeds. Insects of many varieties are attracted to the small flowers.	
Nolina texana Sacahuista	Agavaceae - Agave Family	Succulent 1 1/2' - 3'	Showy whitish flowers. May - June	Capsules. Aug. - Nov.	Full sun, part shade	Prefers rocky soils & open areas on Edwards Plateau, Trans Pecos & northern Rio Grande Plains.	Sands, loams & clays, likes limestone soils. Well-drained, xeric.	X	X				X	Relatively winter-hardy leaf succulent. Good accent plant on dry slopes. Large paniced flowers are hidden inside foliage. Evergreen.	Flowers attract several kinds of insects. The plant is toxic to livestock though. Serves as good protective cover for birds & small mammals. Larval host plant for Sandia & Atea hairstreaks.	
Opuntia imbricata Teddy-bear cholla	Cactaceae - Cactus Family	Succulent 3' - 9'	Showy hot pink flowers. May - June	Bright yellow tunas. Sept. - Oct.	Full sun, part shade	Prefers dry, rocky soils or sandy soils at elevations from 1200 - 1800'	Sands, caliche-like & limestone soils. Well-drained, xeric.					X	X	X	Highly attractive, prickly shrub which is great from landscapes. It becomes tree-like in time. While it is a slow grower, it assumes a marvelous shape with time. If it rains, blooms are shinny. Plant is hard to handle because of spines. Evergreen.	Flowers are highly attractive to several kinds of insects especially bees. Tunas are eaten by several species of birds. A spectacularly safe nesting tree, especially for Cactus Wren and Greater Roadrunner.

Opuntia pneacantha Brown- spine prickly- pear cactus	Cactaceae - Cactus Family	Succulent 1' - 5'	Showy yellow or orange flowers. May - July	Tuna, purplish. Aug. - Sept.	Full sun	Prefers desert, grasslands & mountains. Very widespread species in west Texas.	Sands, loams & clays. Well- drained, xeric.	X	Hardy succulent with attractive flowers & juicy rosy-purplish fruits. Makes a good barrier plant. Evergreen.	Flowers attract many kinds of insects, especially bees, moths, butterflies, beetles & flies, etc. which are attracted to both nectar & pollen. Fruits & pads are highly sought after by several species of mammals which must brave the guard glochids.
Yucca elata Soap tree yucca	Agavaceae - Agave Family	Succulent 3' - 4' leaves, 10' - 18' flower stalk	Showy panicles of creamy- white flowers. April - June	Capsules with seeds. Aug. - Sept.	Full sun	Prefers desert hills & grasslands, gypseous soils above 4000' elevation.	Sands & loams; likes gypsum soils. Well-drained, xeric.	X	Very striking accent plant, lovely when in bloom. Forms a single or multi- trunked succulent. Leaves have tips armed with healthy spines. Flowers are highly showy & also edible. Evergreen.	Elegant waxy flowers emit their fragrance at night attracting yucca moths which pollinate them. Seeds eaten by small mammals. Flowers are edible and popular with mule deer. Larval host plant to Yucca giant skipper.
Yucca faxoniana Faxon yucca	Agavaceae - Agave Family	Succulent 6' - 40'	Showy panicles of dense white flowers on tall stalk. March - April	Capsules, orange to brown turning to black, with seeds. June - July	Full sun	Prefers high desert plateaus, rimrock areas & mountain slopes & flats from 2700' - 6700'.	Sands & loams; likes limestone soils. Well-drained, xeric.	X	Very tall yucca with massive trunk, good as accent plant & lovely when in bloom. These are the giant yuccas. Leaves have tips armed with healthy spines. Flowers are highly showy & also edible. Can serve as excellent evergreen screen. Evergreen.	Elegant waxy flowers emit their fragrance at night attracting yucca moths which pollinate them. Flowers also attract other insects. They are edible and popular with mule deer. Seeds eaten by small mammals. Larval host plant to Yucca giant skipper.
Yucca rostrata Beaked yucca	Agavaceae - Agave Family	Succulent 6' - 12'	Showy panicles of white flowers on tall stalk. March - April	Capsules with seeds. Sept. - Oct.	Full sun	Prefers canyons & mountain slopes especially on limestone substates in West Texas.	Sands & loams; likes limestone soils. Well-drained, xeric.	X	Very tall yucca with massive trunk, good as accent plant & lovely when in bloom. These are the giant yuccas. Leaves have tips armed with healthy spines. Flowers are highly showy & also edible. Evergreen.	Elegant waxy flowers emit their fragrance at night attracting yucca moths which pollinate them. Flowers also attract other insects. They are edible and popular with mule deer. Seeds eaten by small mammals. Larval host plant to Yucca giant skipper.
Yucca treculeana Spanish dagger	Agavaceae - Agave Family	Succulent 5' - 15'	Showy, white & waxy flowers on tall flower stalk, fragrant at night. Feb. - April	Capsules. Sept. - Oct.	Full sun, part shade, dappled shade	Prefers tall chaparral or brushland	Sands, loams, & clays. Well- drained, mesic.	X	Dramatic accent plant with lush tropical-looking flowers. Hard to transplant old ones. This plant is the same as the Torrey yucca. Evergreen.	Moths pollinate fragrant white flowers by night. Good nesting shrub, well-protected. Flowers eaten by many specie of mammals. Larval host plant for Strecker's giant skipper, Ursine giant skipper & Yucca giant skipper.

Clematis drummondii Old man's beard	Ranunculaceae Buttercup Family	Vine, climber	Creamy white to palest yellow flowers. March - Sept.	Achenes, slender & plumose. Aug. - Oct.	Full sun, part shade	Prefers dryish soils, dry washes & rocky canyons, roadsides, fencerows & thickets.	Sands, loams & clays, likes limestone soils. Well-drained, xeric, drought tolerant.	X	X	X	X	X	X	X	X	X	A vigorous climber that will drape other trees & shrubs. Especially beautiful in late summer & fall when the feathery achenes are backlit by the sun, they glisten. This can be a very ornamental vine. Deciduous.	Old man's beard serves as an excellent protective cover & nesting site. Achenes are eaten by many species of birds. Larval host plant of the Fatal metalmark butterfly.
Maurandya antirrhiniflora Snapdragon vine	Scrophulariaceae Figwort Family	Vine climber to 3'	Showy purple flowers. March - Sept.	Capsule, round. Sept. - Dec.	Full sun, part shade	Prefers limestone hills & bluffs, also dunes, shrubs & boulders.	Sands, loams, clays. Well-drained, mesic.	X	X	X	X	X	X	X	X	X	Elegant, delicate-leafed climber & ground cover. Fast grower; tolerates salt. Looks great in a pot. Leaves have excellent fall color. Perennial.	Fruits are a favorite with many species of birds. Flowers are a good nectar source for many kinds of insects, especially butterflies. Lush clumps provide good cover. Larval host plant of Buckeye.
Parthenocissus inserta Thicket creeper	Vitaceae Grape Family	Vine, climber and ground cover	Inconspicuous greenish flowers. May - July	Berries, blue-black. Sept. - Nov.	Full sun	Prefers woods, thickets and on banks in west Texas.	Sands, loams, clays. Well-drained, mesic.							X	X	X	Attractive vine with lush green palmate leaves, thicker & skinnier. Vigorous climber well able to cloak walls, columns, etc. by fastening on to masonry. Also good ground cover. Striking red-orange fall color. Drought-tolerant, prefers full sun. Deciduous.	Many species of birds compete for the blue-black berries including woodpeckers, kingbirds, flycatchers, cardinals, mockingbirds, bluebirds, warblers & sparrows.
Sarcostemma cyananoides Climbing milkweed vine	Asclepiadaceae Milkweed Family	Vine, high climber	Showy pinkish white to purple flowers. April - Aug.	Follicles. July - Oct.	Full sun, part shade	Prefers loose or rocky soils; climbs shrubs & small trees	Sands, loams & clays; likes limestone & caliche-like soils. Well-drained, mesic.	X			X	X	X	X	X	X	Attractive climbing vine of the Milkweed Family with intricate flowers. Deciduous.	Flowers attract several larger insects. Comose seeds used as nesting material. Flattened seeds also eaten by a few birds. Larval host plant of Monarch & Queen.
Sarcostemma torreyi Soft twine vine	Asclepiadaceae Milkweed Family	Vine, high climber	Showy cream-colored flowers with purple spot in umbels. May - Aug.	Follicles, long & pointed with comose seeds. Aug. - Nov.	Full sun, part shade	Prefers dry hillsides & gravelly soils in scrubby woodland associations of Chisos mountain foothills at elevations of less than 3500'.	Sands, loams & clays; like rocky soils. Well-drained, mesic-xeric.							X			Attractive climbing vine with large heart-shaped leaves & curious warty fruit pods in the Milkweed Family. Flowers are highly intricate as others in the milkweed family. Deciduous.	Flowers attract several larger insects. Comose seeds used as nesting material. Flattened seeds also eaten by a few birds & small mammals. Larval host plant of Monarch & Queen.

Vitis arizonica Canyon grape	Vitaceae - Grape Family	Vine, climber	Inconspicuous whitish flowers. May - June	Grapes, blue-black. July - Aug.	Full sun, part shade	Prefers ravines & gulches at altitudes of 2000 - 7000' in western portion of the state.	Sands, loams, clays; likes limestone soils. Well-drained, mesic-xeric.											X	X	Very drought-tolerant climbing vine. Does not like excess moisture. It is also very cold-hardy. Good plant for erosion control. Not really native of the Rolling Plains but will grow well here. Deciduous.	Birds such as doves, several quail, woodpeckers, kingbirds, jays, flycatchers, mockingbirds, pyrruloxias, thrashers, thrushes, finches & sparrows dine voraciously on the fruit. Grapes are also a favorite of fox, skunk & coyotes. Also eaten by mule deer.
Bothriochloa barbinodis Cane bluestem	Poaceae Grass Family	Grass 2' - 4'	Flowering spikelets greenish gray to silvery. May - Oct.	Seeds. Aug. - Nov.	Full sun, a little shade O.K.	Prefers open grassy areas throughout western 2/3rds of state.	Loose limey soils. Well-drained, xeric.		X					X	X	X	X	X	X	A very attractive coarse perennial bunch grass with lovely seed heads. Silvery seed heads catch the rays of the sun making the plant appear to glisten. Warm-season Perennial.	Cane bluestem is a good forage grass for wildlife especially before stems become mature & fibrous. Sparrows & other granivorous birds forage on ripe seeds. Grass parts used as nesting & denning material.
Bouteloua curtipendula Sideoats grama	Poaceae Grass Family	Grass 2' - 6'	Spikelets, yellowish, arranged down along stem. May - Oct.	Seeds. June - Nov.	Full sun, part shade, dappled shade	Tolerates a variety of open places throughout state. Does well in disturbed areas. In gravelly soils of both limestone & igneous substrates	Sands, loams & clays, both limestone & igneous soils. Well-drained, mesic-xeric.		X	X	X	X	X	X	X	X	X	X	X	Our state grass is a strong warm season perennial and works well as a garden accent. Competes well with short grass but not tall-grass prairie grasses. Great for wildflower meadow gardens. Probably most palatable gama grass in Trans-Pecos. Winter dormancy	Provides good grazing for wildlife and an abundance of bird seed for seed-eating birds of several varieties. Food available spring, summer & fall. Grass parts used as nesting & denning material. Larval host plant for Dotted skipper & green skipper.
Bouteloua eriopoda Black grama	Poaceae Grass Family	Grass 1' - 2 1/2'	Spikelets, greenish turning yellowish, arranged down along stem. June - Oct.	Seeds. July - Nov.	Full sun	Prefers dry slopes & plains, often associated with shrubs & subshrubs.	Sands, loams & clays, likes limestone substrates. Well-drained, xeric.							X	X	X	X	X	X	Perennial warm-season grass with wiry stems from a knotty base. Grass stems often arch over. This is an attractive little grass found alot in the rolling hills. Profits from protection from nearby shrubs which afford it a modicum of shade.	Black grama provides good grazing for wildlife. Sparrows & finches and various grosbeaks forage on the ripe seeds. Grass parts used as denning and nesting material.
Bouteloua gracilis Blue grama	Poaceae Grass Family	Grass 1/2' - 3'	Spikelets, densely flowered with bluish cast. June - Oct.	Seeds. July - Nov.	Full sun, a little shade tolerated	Prefers open, grassy plains & rocky slopes in the High & Rolling Plains, also Edwards Plateau & Trans Pecos.	Sandy loams, loams. Well-drained, mesic-xeric.							X		X	X	X	X	This attractive sod-forming perennial grass has stout rhizomes & fine leaves. It is a good choice as a meadow grass as it leaves lots of space for the wildflowers. Can be mixed with Buffalo grass. Needs a little	Provides good grazing for wildlife. Grains eaten by many species of sparrows & finches as well as other seed-eaters.

Chloris virgata Showy chloris	Poaceae Grass Family	Grass 12"	Flowering spikelets yellowish in finger like arrangement . May - Sept.	Sets seed shortly after flowering	Full sun, part shade	Prefers heavy sandy or gravelly soils of disturbed areas, along roadsides, lawns & parks	Sands, heavy	X	X	X	X	X	X	X	X	X	X	This grass is very attractive in shape & color. It can become weedy. Annual.	Showy chloris provides excellent forage during late summer for a variety of herbivores. Seeds are eaten by several species of granivorous birds. Grass parts are used as nesting & denning material.
Digitaria californica California cottontop	Poaceae Grass Family	Grass 1' - 3'	Flowering spikelets greenish to whitish silver. July - Nov.	Sets seed shortly after flowering	Full sun, part shade	Grows on wide variety of soil types in open grassy areas.	Sands, loams & clays. Well-drained, mesic-xeric.	X	X	X	X	X	X	X	X	X	X	An attractive tufted, leafy perennial grass with very pretty seed heads. This pretty grass can be a wonderful accent to the garden. Warm-season perennial.	California cottontop provides good forage for wildlife. Many birds & small mammals eat the ripe seeds. Grass parts are used as nesting & denning material.
Elymus longifolius Long-leaf squirrel-tail	Poaceae Grass Family	Grass 12"	Flowering spikelets yellowish-green. May - Sept.	Sets seed shortly after flowering	Full sun, a little shade O.K.	Prefers dry, open often disturbed areas mainly in desert & montane areas in Franklin & Guadalupe mountains of West Texas.	Sands, loams & clays. Well-drained, xeric.	X	X	X	X	X	X	X	X	X	X	Highly attractive & ornamental grass, very pleasing to the eye. Catches the light beautifully. Warm-season perennial.	Squirrel-tail provides early forage until its mature seed heads develop making it hard to eat. Grass parts are used as nesting & denning material.
Elyonurus barbiculmis Woolspike balsamscalle	Poaceae Grass Family	Grass 1' - 2'	Flowering spikelets greenish to silvery white. June - Nov.	Sets seed shortly after flowering	Full sun, a little shade O.K.	Prefers rocky slopes at elevations of 4000' & above on low rolling hills	Sands & loams; prefers igneous soils. Well-drained, xeric.	X	X	X	X	X	X	X	X	X	X	This is a highly attractive erect perennial with long, hairy slender basal leaves with fragrant lemon odor. Roots are reddish in color. Warm-season perennial.	This grass is not very palatable, but plays important role in grassland ecology. Seeds are eaten by several granivorous mammals & birds. Grass parts are used as nesting & denning material.
Erioneuron pilosus Hairy tridens	Poaceae Grass Family	Grass 7" - 10"	Flowering spikelets silvery white. April - July, sometimes to Oct.	Sets seed shortly after flowering	Full sun, a little shade O.K.	Prefers open rangeland & pastures, along road right-of-ways; also frequent in gravelly soils throughout Trans-Pecos.	Sands, loams & clays, prefers limestone substrates. Well-drained, xeric.	X	X	X	X	X	X	X	X	X	X	Hairy tridens is an attractive short-tufted perennial grass. Very pretty when the seeds ripen & the flowerheads get fluffy looking. Warm-season perennial.	Hairy tridens is not a terribly good forage grass for wildlife, but it does supply some seeds for granivorous birds & small mammals. Grass parts are used as nesting & denning material.
Erioneuron pulchellum Fluff grass	Poaceae Grass Family	Grass 8" - 10"	Flowering spikelets silvery white. June - Nov.	Sets seed shortly after flowering	Full sun, a little shade O.K.	Prefers dry rocky slopes & desert flats with creosote bush in much of the Trans-Pecos.	Sands, loams & clays. Well-drained, xeric.	X	X	X	X	X	X	X	X	X	X	Fluff grass is a gorgeous short-tufted perennial grass with fluffy seed heads. This is another grass that is just beautiful after it has set seed and the sun hits it at the right angle. Warm-	Fluff grass is not considered especially palatable for livestock forage. Seed eating birds and small mammals do eat the ripe seeds, however; and grass parts are used as nesting & denning material.

Muhlenbergia torreyi Torrey muhly	Poaceae Grass Family	Grass 6" - 13"	Flowering spikelets yellowish coral in open flower heads. May - Oct.	Sets seed shortly after flowering	Full sun, a little shade O.K.	Prefers dry, sandy mesas & valleys at lower elevations in the Trans-Pecos.	Sands & sandy loams. Well- drained, xeric.	X	X	X	X	This interesting grass dies out in the middle & forms a circle or ring of new growth. It is highly attractive as the ring breaks into separate clumps. Very distinctive looking, a conversation piece. Warm-season perennial.	Torrey muhly makes excellent cover for small birds & mammals. Ripe seeds are eaten by several species of granivorous birds. Small rodents also eat the seeds. Parts are used as nesting & denning material.			
Pappophorum bicolor Pink pappasgrass	Poaceae Grass Family	Grass 1/2' - 2 1/2'	Flowering spikelets yellowish- pink turning to fluffy pinkish rose. April - Nov.	Seeds. April - Nov.	Full sun, part shade	Prefers grassy plains, moist road rights-of-way & open valleys	Sands, loams & clays. Mesic.	X				X	X	X	This is one of the truly beautiful grasses with its pink fluffy seed head that catches the sunlight. Perennial.	Though it's not a good forage grass, it makes up for it in its beauty. A few birds eat the ripe seeds. Grass parts used for nesting & denning material.
Scleropogon brevifolius Burrograsses	Poaceae Grass Family	Grass 4" - 9"	Flowering spikelets hairy, pink or white. July - Aug.	Seeds. July - Sept.	Full sun, a little shade O.K.	Prefers open, dry, rocky slopes & plains in central & western portions of state.	Sands, loams, clays, caliche-type & calcareous soils. Well-drained, xeric.					X	X	X	Very aggressive but useful landscape grass. Blooms appear after heavy rains. Grass turns greenish after blooming with more rain. More drought-tolerant than Buffalograss. Best to mow after blooming. Perennial that forms thick sod.	Provides poor grazing for wildlife. But good lawn grass in dry areas. Fine leaves used to line bird's nests.
Sporobolus wrightii Alkali sacaton	Poaceae Grass Family	Grass 4' - 6'	Flowering spikelets greenish yellow turning to gold. May - Dec.	Sets seed shortly after flowering	Full sun, a little shade O.K.	Prefers moist clay flats on borders of alkaline or saline areas or on rocky slopes in West Texas.	Clay soils, either saline or alkaline. Poor drainage O.K., mesic-hydric.	X	X			X			Alkali sacaton is great in the proper habitat & under appropriate soil conditions. Strikingly attractive seed head to 12" long with golden spikelets. Forms dense clumps. Is good erosion control plant. Warm-season perennial.	This attractive grass provides good forage for wildlife when actively growing & healthy. Grass parts are used as denning & nesting material. Seeds are eaten by a number of species of granivorous birds.
Trichloris crinata False rhodesgrass	Poaceae Grass Family	Grass 2' - 3'	Flowering spikelets turning silver white in color. May - Sept.	Sets seed shortly after flowering	Full sun, part shade O.K.	Prefers heavy alluvial soils near streams	Sands, loams & clays, calcareous substrate preferred. Well-drained, mesic.					X		X	This absolutely gorgeous grass makes an excellent accent plant for any garden. Very beautiful with 2-inch fingers of white feathery seed heads above blue- green stems. Likes a little extra water. Blooms over long period of time. Warm- season perennial.	Ripe seeds are eaten by several species of granivorous birds & small mammals. Grass parts are used as nesting & denning material.

Aquilegia longissima Yellow columbine	Ranunculaceae Buttercup Family	Wildflower 1' - 3'	Showy yellow flowers with long spurs. May	Follicle with seeds. July	Dappled shade, shade	Grows near rocky crevices in the Trans-Pecos	Sands, loams, limestone or igneous soils. Well-drained, mesic.			X	This native of the Trans Pecos will grow in other areas of Texas such as the Edwards Plateau in proper shady, moist, well-drained habitat. The lemon yellow flowers with the spectacular long spurs are very elegant to behold. Perennial.	Even though the flowers are yellow, hummingbirds will sip nectar from this plant. Insects are also attracted to the flowers.
Argemone polyanthes Crested prickly-poppy	Papaveraceae Poppy Family	Wildflower 1' - 4'	Splashy white crepe-like flowers with yellow center. April - Oct.	Capsule with seeds. June - Nov.	Full sun, part shade	Grows sandy or gravelly soils on prairies, foothills & mesa in northwest portion of Texas. Occurs in Marathon Basin.	Sands, loams, clays, especially gravelly soils. Well-drained, xeric.	X	X	X	This is a very showy, very prickly poppy. Though not vicious, stems & leaves have numerous conspicuous prickles. This is a long-term bloomer with flowers coming out from April to October. Perennial.	Bees, butterflies & especially beetles are attracted to the pollen of this flower.
Baileya multiradiata Desert marigold	Asteraceae Sunflower Family	Wildflower 1' - 1 1/2'	Splashy yellow daisy-like flowers. Dec.	Achenes. Dec.	Full sun, part shade	Grows in flat desert areas in the Trans-Pecos & western portion of the Edwards Plateau.	Sands, loams, clays & caliche-type soils. Well-drained, xeric.	X		X	Spectacular golden long-blooming wildflower that grows in striking clumps. Leaves are a soft woolly gray-green color set off the blossoms beautifully. This hardy drought-tolerant species will bloom for the entire year weather permitting. Perennial.	A wide variety of insects, especially bees & butterflies are attracted to these flowers. Foliage can be toxic to some forms of livestock, especially sheep. Not heavily browsed by Mule deer.
Berlandiera lyrata Chocolate daisy	Asteraceae Sunflower Family	Wildflower 1' - 3'	Showy yellow daisy-like flowers with maroon centers. April - June	Achenes. June - Aug.	Full sun, part shade	Grows on dry rocky limestone soils, open areas, along roadsides.	Sands, loams, clays, limestone-based, caliche-type soils. Well-drained, xeric.	X	X		Sometimes called Brooch flower, this yellow dark-eyed daisy-like wildflower does well in a meadow garden. It's also striking as an accent plant. Very drought-tolerant, it prefers well-drained soils. Perennial.	Bees, butterflies & other insects are attracted to the flowers.
Gutierrezia sarothrae Texas snakeweed	Asteraceae Sunflower Family	Wildflower 1' - 3'	Showy tiny yellow flowers. Sept. - Nov.	Achenes. Oct. - Dec.	Full sun, part shade	Grows in open areas, prairies, fields, meadows on poor, dry soils; also along roadsides.	Sands, loams & clays, limestone-based & caliche type soils. Well-drained, xeric.	X	X	X	This golden bushy plant does very well in poor dry soils & requires very little water. Looks great in a rock garden. Fields are covered in the fall with solid balls of rich golden yellow which last until it freezes. Perennial.	Many small insects, including syrphid flies, small bees & butterflies are attracted by the nectar. These clumps provide great cover for small animals. Seed-eating birds such as finches & sparrows eat the ripe achenes.

Hymenoxys scaposa Slender-stem bitterweed	Asteraceae Sunflower Family	Wildflower 3" - 6"	Showy yellow daisy-like flowers. March - Oct.	Achenes. June - Nov.	Full sun, part shade	Grows on dry calcareous soils & on caliche banks throughout much of western Texas.	Sands, loams, clays, limestone-based & caliche-type soils. Well-drained, xeric.	X	X	X	X	This bright yellow daisy-like flower atop a slender scape is graceful & elegant as it peppers a landscape. The species works well in a rock garden & appreciates good drainage. The plant is highly aromatic. Perennial.	Bees, butterflies & other small insects forage for nectar from the flowers. Ripe achenes are eaten by small seed-eating birds. Foliage is bitter & not highly prized by herbivorous animals.	
Penstemon havardii Havard penstemon	Scrophulariaceae Figwort Family	Wildflower 2' - 6'	Brilliant red tubular flowers on tall stalk. April - June	Capsule, ovoid with numerous seeds. June - Aug.	Full sun, part shade	Grows on limestone soils in the mountains of the Trans-Pecos. Very common in Brewster Co.	Sands, loams, clays & limestone-based soils. Well-drained.				X	This beautiful endemic penstemon can grow very tall. Very drought-tolerant, it's probably best to cut it back after it has bloomed. This plant has excellent landscaping potential. Perennial.	Havard penstemon is a premier hummingbird plant. Sometimes it will bloom again in the fall which is good for migrant hummers returning to their wintering ground.	
Physalis lobata Purple groundcherry	Solanaceae Nightshade Family	Wildflower 2" - 6'	Showy blue-lavender flowers. March - Dec.	Berry, roundish. May - Dec.	Full sun, part shade	Grows in a wide variety of habitats in the western half of the state	Sands, loams, clays, limestone-based soils. Well-drained, xeric.	X	X	X	X	These attractive clumps of blue-lavender flowers can form thick luxuriant carpets of green and blue blanketing the ground. Makes a good ground cover for a perennial bed. Perennial.	Bees, butterflies & other insects are attracted to the flowers.	
Salvia roemeriana Cedar sage	Lamiaceae Mint Family	Wildflower 1' - 2'	Showy red tubular flowers. March - July	Nutlets. May - Sept.	Part shade, dappled shade, full shade	Prefers rocky, shaded woods, canyon edges, bases of limestone outcrops in Edwards Plateau & Trans-Pecos	Sands, loams, clays & limestone-based soils. Well-drained, mesic.	X			X	Cedar sage with its showy red tubular flowers & soft kidney-shaped leaves does supremely well in a shady garden. It makes a great ground cover, growing well in an Ashe juniper association. Perennial.	Black-chinned & Ruby-throated hummingbirds sip nectar from these plants which offer nectar when they first arrive from their wintering grounds. Plants are also popular in the Trans-Pecos to several other species of hummingbirds.	
Zinnia grandiflora Yellow zinnia	Asteraceae Sunflower Family	Wildflower 6" - 8"	Showy yellow flowers. May - Oct.	Achenes. May - Oct.	Full sun, part shade	Grows on dry calcareous substrates in the Trans-Pecos & the Plains country.	Sands, loams, gravelly limestone-based soils. Well-drained, xeric.			X	X	X	These flashy yellow flowers infuse brilliant golden color to the landscape. A great erosion control plant as the tightly-packed needle-like leaves form thick mats over the soil. Yellow zinnia works very well in a dry gravelly-soil rock garden. Perennial.	Bees, butterflies, diurnal moths, syrphid flies are attracted to the flowers.

Amblyolepis setigera Huisache-daisy	Asteraceae Sunflower Family	Wildflower 6" - 18"	Showy golden yellow daisy-like flowers. April - June	Achenes. June - Aug.	Full sun, part shade	Grows in fields, meadows, prairies throughout the western portion of the state.	Sands, loams, caliche-type soils. Well-drained, xeric.	X	X	X	X	X	X	X	X	X	X	Huisache daisy is a few-branched attractive yellow-flowered plant with a two-toned daisy like flower. Looks great in a meadow where it will bloom profusely for over two months. Annual.	Bees, butterflies & other small insects are attracted to flowers. Ripe achenes are eaten by many species of small seed-eating birds.	
Dyssodia pentachaeata Parralena	Asteraceae Sunflower Family	Wildflower 4" - 10"	Small yellow mini-daisies. March - Nov.	Achenes. May - Dec.	Full sun, part shade	Grows on dry loose soils in open areas in central & western portion of the state.	Sands, loams, clays, limestone-based soils. Well-drained, xeric.											There are many species & varieties of this plant that are adapted to various parts of the state. They are all aromatic, have petite perky yellow flowers & are great for rock gardens. Annual.	Small bees, butterflies & other insects are attracted to the flowers. Mule deer will only feed on this when very hungry. Livestock will also ignore this plant as potential forage.	
Eryngium leavenworthii Eryngo	Apiaceae Parsley Family	Wildflower 1' - 2'	Unusual magenta thistle-like flowers. Aug. - Sept.	Schizocarp with 2 mericarps. Oct. - Nov.	Full sun, part shade	Grows in open areas on plains & prairies throughout most of the state	Sands, loams, clays, limestone-based & caliche-like soils. Well-drained, xeric.	X	X	X	X	X	X	X	X	X	X	Very distinctive prickly plant with curious spiny bracts and fuzzy magenta flowers. This is a good plant for a meadow garden in a place that does not get much people traffic. Makes a great colorful display & is always a conversation piece. Annual.	Several species of insects are attracted to the small flowers. Makes a good protective cover plant when found close together. Seed eating birds forage on the ripe mericarps.	
Eschscholzia mexicana Mexican gold poppy	Papaveraceae Poppy Family	Wildflower 1/2' - 1'	Gorgeous golden flowers. March - May	Capsule, ribbed with 2 valves & many seeds. March - May	Full sun, small amount of shade O.K.	Grows on limestone slopes of the Franklin Mountains in El Paso also found near the city of Lajitas.	Sands, loams & limestone-based soils. Well-drained, xeric.										X	These incredibly beautiful golden poppies make a magnificent sight when in full bloom. Lacy blue-green foliage sets off the orange-gold flowers. Grows well on rocky limestone slopes. Annual.	Myriads of insects such as bees & butterflies are attracted to the flowers.	
Gaillardia pulchella Indian blanket	Asteraceae Sunflower Family	Wildflower 1'	Showy yellow & red daisy-like flowers. March - Oct.	Achenes. May - Nov.	Full sun, part shade	Prefers open grassy areas, prairies, meadows, also disturbed areas in a variety of soils	Sands, loams & clays. Well-drained, mesic-xeric.	X	X	X	X	X	X	X	X	X	X	X	This is a marvelously easy wildflower to grow & it comes in various coloration patters from mainly yellow to mostly reddish. Blooms most of the season from spring to late fall & provides lots of color to a wildflower meadow. Annual.	Indian blanket attracts bees, butterflies & several other varieties of small insects who forage on the nectar. Ripe seed heads are favorites with many species of seed-eating passerines like the Painted Bunting.

Ipomopsis aggregata Scarlet standing-cypress	Polemoniaceae Phlox Family	Wildflower 3' - 5'	Showy red tubular flowers with yellow splotches. Aug. - Oct.	Capsule with seeds. Oct. - Nov.	Full sun, part shade	Grows in igneous soils on dry rocky slopes in the Trans-Pecos especially in the Davis Mountains above 4000'	Sands & loams, likes igneous soils. Well-drained, xeric.										X	This spectacular flower with red tubular flowers & elegantly dissected leaves thrives in high desert habitats. Rosettes are present throughout most of the winter. Annual.	This is a popular plant with the many hummingbirds of the area which zip from flower to flower sipping nectar & pollinating the plant.
Lepidium montanum Mountain peppergrass	Brassicaceae Mustard Family	Wildflower 1' - 2'	Showy white flowers. March - June	Silicles. May - Aug.	Full sun, part shade	Grows in sandy, calcareous or saline soils in open areas, deserts, brushlands, rangelands & openings on cedar slopes in Panhandle & southwest Texas	Sands, loams, limestone-based & caliche-type soils. Well-drained, xeric.							X	X	X	X	These low dense plants are spectacular when in bloom. Works well with clumps placed near rocks or used as a border. It prefers full sun with well-drained soils. Flowers are open only in the morning. Biennial.	Bees, butterflies & other small nectar-loving insects attend the mounds of white flowers in the morning. Larval host plant of the Checkered white butterfly.
Lupinus havardii Big Bend lupine	Leguminosae Legume Family	Wildflower 2' - 4'	Showy blue & white flowers. Jan. - June	Leguminous pod with seeds. March - Aug.	Full sun, a small amount of shade O.K.	Grows on open gravelly flats near the Chisos Mountains also the rolling limestone hills from the mouth of the Pecos River to Del Rio in the Trans-Pecos.	Sands & loams & gravelly limestone-based soils. Well-drained, xeric.										X	With good rains, Big Bend bluebonnet can create an incredible sea of blue in the desert landscape extending from the river bottoms to the top of the mountains. Annual.	Insects, especially bees gather nectar from the flowers. Mule deer love to browse the foliage of this plant.
Machaeranthera tanacetifolia Tahoka daisy	Asteraceae Sunflower Family	Wildflower 6" - 12"	Showy magenta daisy-like flowers with yellow centers. March - May	Achenes. May - July	Full sun, part shade	Occurs on gravelly soil flatlands, fields, prairies in the Rolling Plains, High Plains & the Trans-Pecos.	Sands, loams, clays & caliche-type soils. Well-drained, xeric.							X	X	X		Absolutely beautiful wildflower produces thick continuous blossoms for about two months before they fade. These plants work well in a shortgrass meadow or on a rocky hillside. The plant also does well in a rock garden. They love good drainage. Annual.	Tahoka daisy attracts many small bees, butterflies & other insects that are attracted to the nectar. Ripe achenes are sought after by several species of seed-eating birds.
Monarda citriodora Horsemint	Lamiaceae Mint Family	Wildflower 1 - 2"	Showy purple tripartite spikes. April - June	Schizocarp with 4 brown nutlets. June - Aug.	Full sun, part shade	Prefers slopes, prairies & meadows throughout Texas	Sands, loams & clays. Well-drained, mesic-xeric.	X	X	X	X	X	X	X	X	X	X	Aromatic meadow wildflower that is easy to grow. Flowers continue to bloom right through the summer. Does really well planted with Indian blanket amongst species of native grasses. Annual.	Horsemint attracts butterflies, bees & a wide variety of other insects who forage on the nectar.

Pectis angustifolia Limoncillo	Asteraceae Sunflower Family	Wildflower 6" - 10"	Petite yellow daisy-like flowers. June - Oct.	Achenes. Aug. - Nov.	Full sun, part shade	Grows on dry calcareous soils of uplands in Edwards Plateau west to Trans-Pecos	Sands, loams, gravelly caliche-type soils. Well-drained, xeric.	X	X	X	Attractive clumps of petite daisy-like flowers and narrow highly aromatic leaves. Lemoncillo forms low-growing little mats in a rock garden. Good for borders along walkways or walls. Also good in mass plantings. Smells heavenly. Annual.	Bees, butterflies & other small nectar-loving insects are attracted to the flowers. Deer do not browse the foliage of this plant. Ripe achenes are eaten by small seed-eating birds.	
Psilostrophe tagetina Paperflower	Asteraceae Sunflower Family	Wildflower 1' - 1 1/2'	Showy yellow daisy-like flowers. Feb. - Oct.	Achenes. April - Nov.	Full sun, some shade O.K.	Grows in various soils in plains, rangelands, along hillsides & on slopes.	Sands, loams & clays. Well-drained, xeric.	X	X	X	X	Herbage is attractive coated with dense, woolly coating of soft hairs which allows it to survive the extremely hot dry conditions of its desert habitat. Flowers are thick & showy for long periods of time. Annual or short-lived Perennial.	Bees, butterflies & other small insects forage for nectar from the flowers. Foliage can be toxic to livestock. Mule deer do not browse this plant.



Learn About Whitetails

by Robert L. Cook

Updated and revised by Horace G. Gore, 1989

From *Texas Parks and Wildlife Magazine*

October 1975

Exploration and settlement of the American frontier would have been extremely difficult without the white-tailed deer. Early colonists and explorers utilized the meat and skins of these animals extensively, and deer hides later served as a medium of exchange between trappers, frontier scouts, Indians and traders.

Deer were even more important to the American Indians prior to settlement of the nation, providing clothing and food. Deer were also an important factor in the folklore and religion of native tribesmen.

Indiscriminate slaughter by commercial meat and hide hunters and ignorance of the deer's habitat requirements almost caused its extermination near the end of the 19th century. It was reported, for example, that an early Texas trader operating in Indian country at Trading House Creek (near present site of Waco) shipped approximately 75,000 deer skins from 1844 through 1853.

Public concern for survival of the species brought about a series of protective measures by the Texas Legislature near the turn of the century. A five-month closed season during

which deer could not be hunted was enacted in 1881. The bag limit was established at six bucks per season in 1903 and was reduced to three bucks per season in 1907.

The first hunting licenses were sold in Texas in 1909. In 1919, six game wardens were hired to patrol the entire state.

Additional interest and protection by landowners, sportsmen and law enforcement personnel helped deer populations increase steadily during the 1930s and 1940s. Statewide trapping and restocking programs established deer herds in previously uninhabited areas. Sales of hunting licenses increased dramatically—382,249 in 1955, 571,058 in 1964 and over one million in 1972.

The white-tailed deer is now the most numerous big game animal in Texas and in the United States. Aesthetically and emotionally, the whitetail holds a place of distinction in the hearts and minds of many Texans.

Research and management projects concerning the whitetail and its habitat requirements are conducted by wildlife biologists of the Texas Parks and Wildlife Department, federal agencies, many universities and several private research establishments in Texas.

Research activities by the wildlife biologists of the Texas Parks and Wildlife Department are 75 percent funded from federal excise taxes on firearms and ammunition. Deer are of primary importance on several of the 119 wildlife management areas (900,000 acres) operated by this department. Research activities also are conducted on National Wildlife Refuges, National Forests and Department of Defense lands. The Texas Parks and Wildlife Department game warden field force now numbers some 460 officers. These highly skilled and trained officers provide law enforcement services essential to continued survival of the whitetail.

The whitetail is one of the most researched, observed, sought after, cussed and discussed of all wildlife species in Texas. Few of us, however, are aware of the basic principles which rule this majestic animal's life. Following are some of the most frequently asked questions about white-tailed deer in Texas.

How many kinds of deer are there in Texas?

The Texas white-tailed deer, *Odocoileus virginianus texana*, occurs almost statewide. There were several subspecies of whitetail in the state years ago. However, due to expanding-overlapping ranges and restocking efforts in recent times, the subtle differences between subspecies have been lost except for the isolated population of Carmen Mountain white-tailed deer, *Odocoileus virginianus carminus*, in the Big Bend National Park area. Although found almost statewide in brushy or wooded areas, the heaviest deer populations are located in the central one-third of the state. The mule deer, *Odocoileus hemionus*, is a different species which occurs primarily west of the Pecos River and in parts of the High Plains of the Texas Panhandle.

How many deer are there in Texas?

Texas has more white-tailed deer than any other state. Population estimates in recent years range from three to four million. Current census data indicate that there are more than

four million whitetails in Texas. Population estimates vary from year to year, depending upon reproduction, survival and losses due to malnutrition and disease.

How many white-tailed deer are legally harvested by sportsmen in Texas each year?

An estimated 500,000 whitetails are harvested by sportsmen in Texas annually—more than any other state.

Isn't that too many?

No. Current harvest rates account for only about ten percent of the herd annually. Research indicates that about 20 percent of most populations should be removed annually by sportsmen. Biologically sound harvest rates and habitat management programs are necessary in Texas to prevent waste due to overpopulation, to achieve maximum utilization of this valuable natural resource and to insure the whitetail's continued survival. For example, since the initiation of the program in 1953, more than two million antlerless or doe deer have been harvested from the established deer herds in the state.

How are deer counted?

Several methods of estimating deer numbers are used in Texas:

1. The walking deer cruise line. During the fall months, wildlife biologists walk census lines which have been placed in representative deer habitat and count the deer observed. This method is used extensively in Texas, and there are several hundred such deer census lines in the state.

2. Counts from fixed-winged aircraft. This method is used in areas of the South Texas brush country. Observers count deer seen on strips of deer habitat of known width and length.

3. Track count method. Counting deer tracks on selected sites during late summer is a method frequently used in heavily wooded areas of East Texas.

4. Spotlight counts. Counting deer at night with the use of spotlights along pasture roads or lightly traveled public roads is a method biologists have recently put into use. It is an excellent census method in areas with low deer populations. **Caution:** Biologists always notify all landowners along their spotlight census routes. They drive vehicles clearly marked "Texas Parks and Wildlife Department" and "Deer Census." Any other spotlighters should be reported to the local game warden.

5. Several other deer census methods are used by Parks and Wildlife Department personnel. Counts from helicopters and late evening counts from vehicles are good deer census techniques.

What do deer eat?

Deer eat mostly browse (leaves, twigs, young shoots of woody plants and vines) and forbs (weeds and other broad-leaved flowering plants). They eat some grass, but only when



Each summer the whitetail grows a new set of antlers. When the breeding season begins, the velvet (above) is shed and the antlers become hard and polished.

it is green and succulent. Sheep, goats and foreign big game species compete directly with the whitetail for preferred deer foods. Deer food shortages usually occur during late summer and winter months. Adequate forage is usually available during spring and fall seasons. A variety of foods and habitat types is essential to good deer production and survival.

The following plants are examples of some good native deer foods in Texas which are readily taken by deer when and where they are available.

Browse: oak leaves and acorns, yaupon, greenbriar, prickly pear and fruit, hackberry, mulberry, rattan or supplejack, sumac, mesquite beans and dried leaves, hawthorns, poison oak, American beautyberry, wild cherry and plum, wild grape, honeysuckle, dogwood, elm, blackberry and dewberry, gum elastic (chittum), acacias (catclaw), ephedra, walnut, guayacan, wild chinaberry, kidneywood, Brasil and other condalias.

Grasses: rescue grass, Texas wintergrass, Ozarkgrass, fall witchgrass, panic grasses, sedges and rushes.

Forbs: bundle flower, euphorbia(s), whorled nodviolet, bayflower, oxalis, wooleywhite, tickclovers, filaree, clover, verbena, arrowleaf sida, wild lettuce, wild onions, old man's beard, wildbean, snoutbean, lespedezas, spiderwort, vetches (milkveitch, etc.) lamb's quarters, plantain, groundcherry, pigweed or carelessweed and partridge peas.

How long do deer live?

Deer in controlled situations have been known to live 15 to 20 years. It is unusual, however, for a deer in the wild to live more than 10 years, because its teeth usually wear out during the eighth or ninth year.

How can the age of a deer be determined? Is the number of antler points one method?

Deer age is determined by tooth replacement and tooth wear of the premolars and molars (back teeth) of the lower jaw. Unlike sheep, deer cannot be aged by their front teeth, and age cannot be determined by antler characteristics.

Does a buck deer keep the same set of antlers each year?

No. A buck grows a new set of antlers (not horns) each summer. The size of the antlers depends primarily upon the quality and quantity of food the buck eats and his age. The more nutritious the food and the more there is of it during the antler-growing season, the better his antlers will be. With favorable conditions, antler size and spread will increase with deer age. After the sixth year, however, antlers usually decline in size due to the deer's inability to properly chew and digest food.

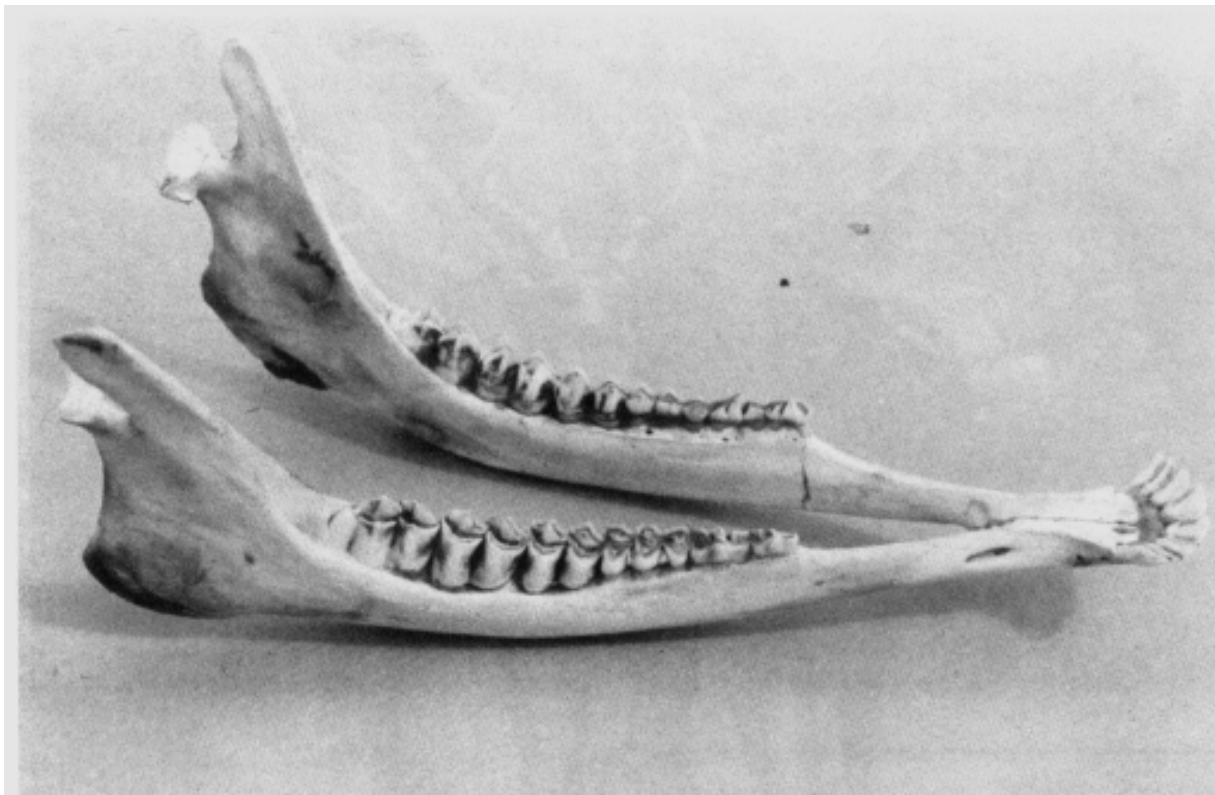

By noting tooth replacement and tooth wear of the premolars and molars of the lower jaw, biologists determined that this deer was 1½ years old.

What happens to the antlers each year?

Buck deer shed their antlers following the mating season each year. Antler shedding is triggered by the cessation of production of a hormone which also terminates the breeding season. Most bucks in Texas shed their antlers during late January and February. Shed antlers quickly deteriorate or are eaten by rodents and other animals for their calcium content. New antlers start growing and become noticeable "in velvet" during May and June. Good nutrition during this period is critical for good antler growth.

Shouldn't spike bucks be protected since they are young and will be the breeding bucks of the future?

Not necessarily. Most spike bucks are young deer, but if range conditions are poor, there may be spikes of any age. If a herd contains many spikes, the deer probably did not have sufficient quality forage during antler-growing season (May-August). It would serve no logical purpose to protect the spike buck. Research conducted on the Kerr Wildlife Area has shown that all young spike bucks do not develop into the same quality of buck as do most yearling bucks with forked antlers. Some young spikes will produce very good antlers later in life, but the chances for massive antlers is not as good as with forked antlered yearlings. Spikes should be harvested based on the intensity of management desired by each landowner or group of hunters. Spikes should never be protected from hunting. The idea that the removal of spikes is a cure-all for antler development has little merit.

When is the breeding season?

The breeding season for white-tailed deer in Texas ranges through the fall and winter months from about the first of September through mid-January. The peak breeding activity occurs in mid-November in Central Texas and late December in South Texas.

What is a good buck-doe ratio?

The buck-doe ratio in most of Texas is about one buck per three to five does (adult deer) which is satisfactory for good production and hunting. This ratio is not a major problem in Texas deer herd management at this time. An adequate harvest of antlerless deer would help maintain a good ratio of both sexes. It is recommended that game managers and landowners strive for a ratio of 2.5 does per buck.

Won't the deer become smaller due to inbreeding if we don't bring some new blood lines?

No. The deer of Texas are direct descendants of isolated deer herds of many years ago. Inbreeding may occur in the wild, but it apparently is no problem. New blood lines are quickly absorbed into established genetic pools and no improvement in quality is noticed. Inferior quality or small deer result from poor range conditions or insufficient preferred forage and will not be improved by bringing in new bucks.

Does the Texas Parks and Wildlife Department restock deer?

Yes, but only in approved areas judged as potentially good deer habitat which presently have few or no deer. The deer trapping and restocking program was initiated in 1938 by the Game, Fish and Oyster Commission, predecessor of the Texas Parks and Wildlife Department. Since that time, more than 30,000 deer have been released in 160 Texas counties.

How many fawns will a doe have?

Normally, a doe deer in Texas will have her first fawn, which is usually a single, when she is two years old. Thereafter, if food conditions are adequate, the doe should normally have twin fawns almost every year until her sixth or seventh year, when the reproductive rate will begin to decline. Triplet fawns are uncommon, but do occur. Quadruplets have been reported.

The gestation period for deer is seven months.

According to reproductive studies, "old barren does," or does that have never produced fawns, are uncommon and are no problem to deer herd management. The key to maximum production is an adequate supply of nutritious natural food.

Are more female fawns born than male fawns?

No. Male and female fawns are born in approximately equal numbers.

What are the most serious threats to deer herds in Texas?

1. Habitat destruction such as land clearing, root plowing, improved grass pastures, subdivisions, new lakes, expanding cities, etc.
2. Poor range or inadequate food supplies due to overgrazing by domestic livestock and overpopulations of deer, resulting in large-scale deer die-offs.
3. Disease and parasites.
4. Illegal hunting.

What are some of the most important limiting factors affecting white-tailed deer?

Rainfall is an important limiting factor. Extended periods of severe drought during the late summer and fall are especially harmful to fawns, yearlings and very old deer. Coyotes are a limiting factor in South Texas and in portions of Southeast-Central Texas. However, natural predators, such as coyotes, bobcats or eagles presently pose no serious threats to established deer herds of Texas. Efforts to control these predators are usually expensive and ineffective with regard to white-tailed deer.

What about hunting?

Legal hunting can be a limiting factor but is not currently a threat to deer populations. In fact, regulated hunting is the best way to crop the deer herd annually, much like a farmer-rancher would crop his herds of domestic livestock. Properly controlled and regulated, hunting is the most reasonable and humane method of maintaining and utilizing the extensive deer populations of Texas.

Will deer move great distances?

Not normally. A deer chased by dogs may run several miles, but will often circle and end up close to home. During the breeding season, some bucks will trail female deer out of their normal home range but will later return. Movement studies and radio-tracking research in Texas indicated that most deer spend their lives within about 1.5 miles of their birthplace.

What can I do to help the deer, increase deer numbers or improve the quality of deer?

1. Learn about the habitat requirements of deer. Become familiar with preferred deer foods in your area or the area where you vacation or hunt. Support practices which create good wildlife habitat and prevent destruction of existing habitat.
2. Landowners and operators should make every effort to provide adequate habitat and forage for deer and other wildlife. Competition by domestic sheep and goats should be reduced in some cases. Both sexes of deer should be reasonably, but adequately, harvested each year from well-established herds.
3. Sportsmen should obey state laws and those rules established by landowners. Sportsmen should not abuse the land on which they hunt, trespass where they do not have permission, take "sound shots" or misuse a firearm.
4. Everyone should cooperate with law enforcement officers responsible for protection of our wildlife. Violations should be reported immediately to the nearest game warden of the Parks and Wildlife Department, or to Operation Game Thief at 1-800-792-GAME.
5. Landowners and hunters can provide a significant service to the game management programs of Texas by completely and accurately providing harvest data. Whether it is solicited by mail questionnaire or in person by biologists in the field, at check stations or cold storage facilities, valid harvest information is vital to the formulation of effective hunting regulations. These regulations will allow the maximum harvest of surplus animals without endangering the broodstock necessary to replenish those populations.

Would it help to feed the deer some supplemental feed?

If deer take large quantities of supplemental feed (corn, etc.), there probably is a shortage of their natural preferred foods. The best solution to the problem is to improve availability of natural foods. Obviously, this cannot be achieved quickly and will result only from proper range management practices (grazing moderately, rotation grazing systems, etc.). If artificial feeding is necessary, deer should be supplied high-quality (14 to 16 percent protein) 3/16" pellets instead of corn, which is about eight percent protein. Marked improvement in body size and antler development should not be expected from artificial or supplemental feeding.

Researchers in Texas and other states have worked many years to obtain answers to some of the many questions concerning the white-tailed deer, its requirements and management. Continued research will reveal additional necessary information about this and other wildlife species. The well-being and continued survival of the whitetail in Texas, however, is dependent primarily upon the interest and concern of sportsmen, landowners and the conservation-minded public of our state.

How To Age Deer

GENERAL ANATOMY OF LOWER MOLAR

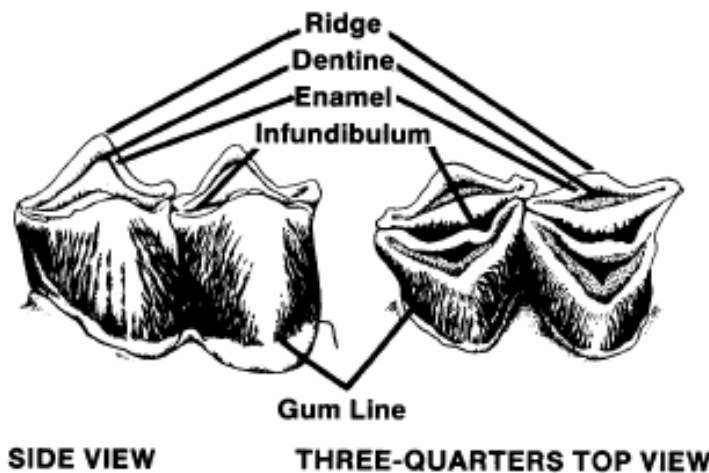

Age of a deer is determined by tooth replacement and wear on molars and premolars of the lower jaw. As a deer grows older, certain portions of its teeth are worn enough to show definite differences from the teeth of other age classes.

A deer has only six jaw teeth, although they appear to have many more. The teeth are broken into two distinct categories: the premolars, which are numbered 1, 2, and 3, and the molars, which are numbered 4, 5, and 6.

Deer are aged in fractions because they are born around July and are killed during the hunting season.

1½ year old: (*long yearling*): The long yearling deer is the most easily recognized of all age classes. The first three jaw teeth are milk teeth, which will be replaced around two years of age. These are worn smooth as a long yearling, while the last three teeth remain sharp. The number 3 tooth has three cusps in the milk tooth stage, but only two cusps appear on the replaced tooth. Fawns in their first season will show little evidence of wear on their milk teeth.

2½ year old: The first three jaw teeth have been replaced by permanent teeth and all molars are sharp. The dentine of the first molar (tooth 4) is not as wide as the enamel which surrounds it.

3½ year old: The dentine in the first molar (tooth 4) is now as wide or wider than the enamel which surrounds it, and this is not true of the second molar or tooth 5.

4½ year old: The dentine of the first and second molars (teeth 4 and 5) is as wide or wider on both teeth, but not in tooth 6.

5½ year old: The dentine of all molars (teeth 4, 5, and 6) is now as wide or wider than the enamel surrounding it.

6½ year old: The first molar (tooth 4) is worn smooth, but teeth 5 and 6 are not smooth.

7½ year old: The first and second molars (teeth 4 and 5) are worn smooth, or tooth 5 may still have a small ridge left.

8½ year old: All molar teeth are worn smooth (teeth 4, 5, and 6), but tooth 6 may still have a small ridge left.

Older than 8½ year old: Unable to determine, because characteristic formations have all been worn smooth.

The primary factor governing antler formation is food supply. As deer grow older and their teeth wear flatter, food becomes harder and harder to chew. Body condition will drop and, simultaneously, so will antler development.



TOP VIEW

1½



5½



SIDE VIEW

1 2 3 4 5 6



1 2 3 4 5 6



2½



6½



1 2 3 4 5 6



1 2 3 4 5 6



3½



7½



1 2 3 4 5 6

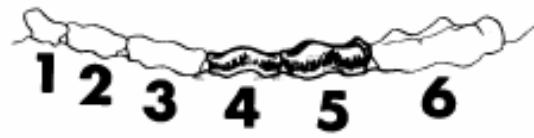

1 2 3 4 5 6



4½



8½



1 2 3 4 5 6



1 2 3 4 5 6

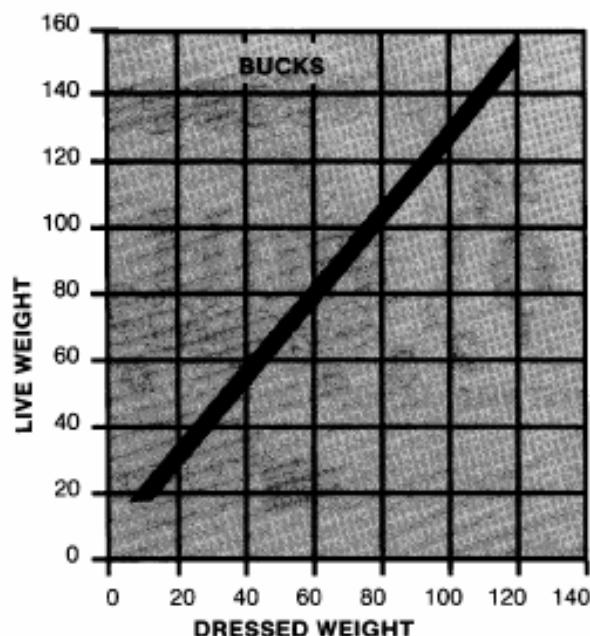

Find dressed weight of buck in figures at bottom of chart and trace line up to diagonal. From intersection, trace line to scale at left and read live weight. Reverse this procedure to determine dressed weight of live animal.

Does are lighter than bucks so a different chart must be used. As above, find dressed weight of doe in scale at bottom, trace up to diagonal, then from intersection trace line to left and read estimated live weight.

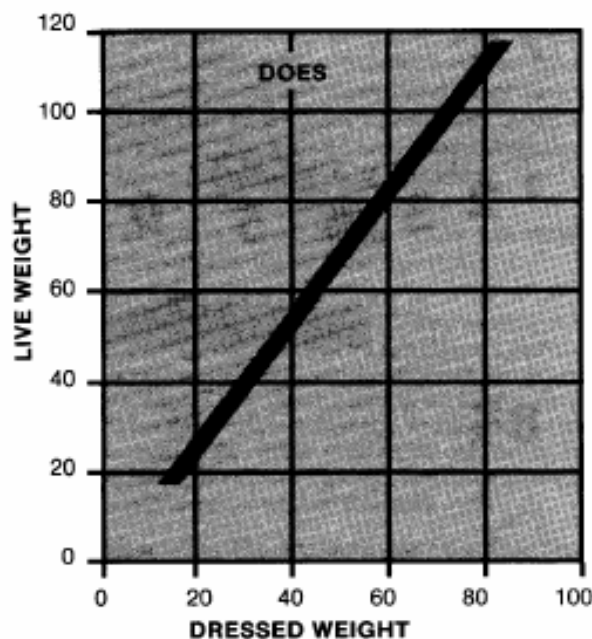

The Way to Weigh

by Charles Ramsey
and
Melvin J. Anderegg

A PICKUP with two hunters drove up to the deer check station on the Kerr Wildlife Management Area. Both hunters climbed out, and walked around to the back of the truck and began unloading a couple of deer.

The first deer, a small doe, was tossed upon the table in the check station. Area personnel field dressed the deer and recorded descriptive measurements and weights. Then the doe was loaded back into the truck.

The second deer, a large buck, was lifted onto the table and the process of measuring and recording was repeated. Since the buck was already field dressed, only a dressed weight was taken—106 pounds field dressed. How big was that deer on the hoof?

This question has been repeated so many times at the check station that two graphs were prepared to help with the answer. These graphs represent the weights taken from approximately 200 deer in good body condition killed on the Kerr Wildlife Management Area. Since these deer were typical of the Edwards Plateau, the graphs will be applicable for deer taken within the Hill country. Although not as accurate, they are also good guides for deer taken from other areas of the state.

Dressed weight means "field dressed" with head, hide, and feet left on the carcass.

Visit the outdoors each month through the full-color pages of *Texas Parks & Wildlife* magazine.

To subscribe, call 1-800-792-1112 Monday through Friday between 8 a.m. and 5 p.m.

Rates:

1 year \$10	Foreign 1 year \$12
2 years \$18	Foreign 2 years \$21
3 years \$26	Foreign 3 years \$30

(Domestic rates include APO & FPO)

TEXAS PARKS & WILDLIFE Magazine
4200 Smith School Road
Austin, Texas 78744

APPENDIX BB

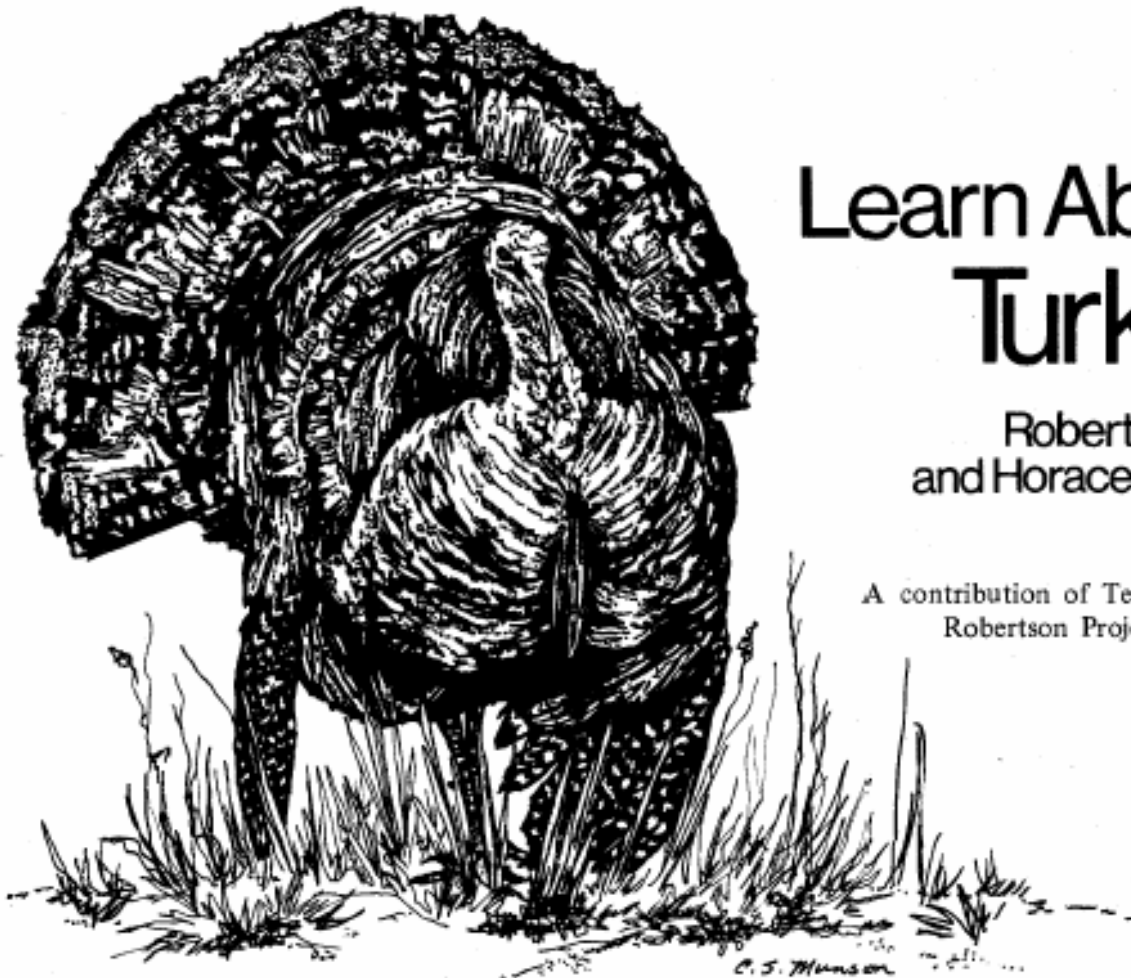

Learn About Turkey

Robert L. Cook
and Horace G. Gore

A contribution of Texas Pittman-
Robertson Project FW-14-C.

Turkey were almost exterminated in Texas by late in the 19th century. However, the first step was taken to protect these game birds in 1897 when trapping was outlawed for five months of the year. In 1903, a bag limit of 25 turkey per day throughout a five-month season was initiated. These liberal restrictions failed to help the turkey in most of its range, since there were few game wardens to enforce the laws.

In 1919, the legislature created a bag limit of three bearded gobblers per season. Increased protection by conservation-minded landowners and additional game wardens in the 1920s helped turkey populations to begin a steady increase. Also, since that time, the Texas Parks and Wildlife Department has trapped over 10,000 turkey and restocked them to suitable habitat throughout the state in an effort to restore the wild turkey to its historic range.

There are presently two varieties of wild turkey common to Texas. The Eastern turkey, *Meleagris gallopavo silvestris*, is found in the forests and dense thickets of East Texas and is rarely seen because of its wariness and scarcity. The Rio Grande turkey, *Meleagris gallopavo intermedia*, is found in most of South, Central and North Texas. The Merriam's turkey, *Melagris gallopavo merriami*, once roamed the mountains of West Texas, but were extirpated by 1907.

Attempts to restock this turkey have not been successful.

In general, the Eastern turkey is darker and larger than the more common Rio Grande variety. A mature Rio Grande gobbler averages 16 to 18 pounds, while the Eastern bird averages 19 to 21 pounds.

Biologists of the Parks and Wildlife Department are trying to save Texas' Eastern turkey and restore it to its former range. The few remaining birds are carefully protected by game wardens and landowners, and efforts to restock suitable areas with wild-trapped birds are made each year. Efforts are also being made to develop a hybrid turkey which could be satisfactorily established in portions of East Texas.

Following are some of the most often asked questions about wild turkey in Texas.

How long do wild turkey live?

Turkey live an average of two to three years; however, upon reaching maturity their life expectancy increases substantially. Most mortality occurs in poults (young-of-the-year) and yearlings. A few birds have been known to live as long as 10 years.

Where did the wild turkey come from?

Wild turkey are native to America and probably evolved from pheasantlike ancestors. American Indians ate turkey and

used the feathers to adorn themselves and their weapons. Cortez, the Spanish explorer, found the Aztecs and other Indians in Mexico in possession of domesticated wild turkey in 1519. The explorer Vasco de Gama introduced the wild turkey into Europe.

What do turkey eat?

Turkey are primarily vegetarians, although they eat many insects, snails and other invertebrates. Major food items during the spring and summer are green grasses and forbs (weeds), buds, flowers, seeds and insects. In the fall and winter, turkey take fruits, most such as pecans and acorns and green forage such as Texas winter grass, oats or wheat, depending upon availability.

How many eggs does a hen usually lay?

Ten or 11 eggs make up the average clutch laid by each hen, and it takes her about two weeks to lay them. Most eggs are fertile and will hatch upon completion of the 28-day incubation period if not destroyed or unduly disturbed.

Do most of the eggs hatch or does something happen to them before the incubation period is complete?

Overall nesting success in turkey is similar to that of most ground-nesting birds. About one-third of all eggs laid will eventually hatch. Weather is the main factor limiting Rio Grande turkey nesting success. If there is insufficient ground moisture, the eggs will get too hot and dry during incubation and the embryo will die. Studies indicate that almost one-half of all turkey nests are destroyed by predators. If weather conditions are good, however, a reasonably good turkey hatch can be expected in spite of predators and other limiting factors.

How long do the hen and young stay on the nest?

The hen and newly hatched poults stay on the nest about one full day. Poults begin to roost in trees at about two weeks of age, but can fly well for short distances at 10 days. During this critical period, predators account for many poult losses. Although a hen may have hatched nine or 10 poults, only two or three may be left at the summer's end.

Can a bearded turkey hen raise young?

Yes. They (about 15 percent of all Rio Grande hens in Texas have visible beards) are as productive as hens without beards. Beards appear on older hens and increase in size and thickness with age.

Why are some wild turkey gray or even white?

Gray or white turkey in the wild are usually genetic color aberrancies compared to the well known "black sheep." They are not domestic turkey gone wild or descendants of domestic turkey. White or gray turkey are often wilder than turkey of normal coloration.

What is the most important limiting factor on Rio Grande turkey?

Weather, especially dry weather in Texas. Droughts lasting several months may cause reductions of up to 50 percent in wild turkey flocks. During dry weather, turkey are weakened by poor forage conditions and are more susceptible to disease, parasites and predators. Most turkey eggs will not hatch in hot, dry weather and the few poults that do hatch must soon have moisture to survive. Sufficient rainfall during the late spring and early summer months is essential to good turkey production and survival.

Wouldn't a good predator control program increase turkey numbers?

Not necessarily. Wild turkey have survived and reproduced for thousands of years in spite of the presence of every known predator in North America. With good weather and range conditions, turkey have little trouble contending with pressure from predators. In addition, it is expensive and difficult to effectively reduce predator populations.

Why do we hunt turkey?

Turkey provide thousands of hours of recreation for sportsmen as well as a delicious addition to the menu. Legal hunting pressure has never been a limiting factor on turkey in Texas since less than 10 percent of the entire population is harvested by hunters annually. Turkey can withstand an annual harvest of at least 20 percent of the population. If these birds are not taken by sportsmen during the hunting season, they will eventually die and be wasted.

Shouldn't we protect hens?

To properly harvest turkey and maintain sex ratios, it is absolutely necessary to harvest both hens and gobblers. Ranchers wouldn't sell only the male offspring from their livestock herds. The same principle applies to turkey since surpluses occur in both sexes. Continual harvest of one sex will create an imbalance in the sex ratio. In addition, turkey hens are difficult to distinguish from young gobblers, and the average hunter finds it almost impossible to distinguish a bearded hen from a gobbler. As in the case with most game birds (waterfowl, quail, dove), it is practical to allow and encourage the harvest of both sexes. A reasonable either-sex harvest will not hinder turkey production.

Why hunt gobblers in the spring mating season?

Although the spring gobbler season is relatively new to most Texans, it is traditional in most southern states and is probably the most practical of all hunting seasons, since it is held after the hens have been bred and are laying or incubating eggs. Hunting game animals during their breeding season is a common and established principle to big game hunters. Because of his gobbling and strutting activities, the male turkey is easier to distinguish this time of year. Hunters can also use calls to lure gobblers within range.

Hens need to be bred only once each spring to fertilize their entire clutch of eggs and each dominant gobbler usually mates with about ten hens. Since sexes are born in equal numbers, it is easy to see how a surplus of gobblers can occur under this arrangement. After the hens are bred and no longer need the gobbler for mating, most of the gobblers could be harvested. Bag limit during the spring season in Texas is one gobbler per hunter; therefore, there is no danger of reducing the productivity of the flocks by harvesting gobblers each spring.

Should I try to restock turkey on my place?

Restocking is one of the most important factors in our turkey management program in Texas, but restocking efforts should not be made in areas that are no longer suitable for the birds. Extensive land clearing practices have eliminated thousands of acres of good turkey habitat, and continuous overgrazing by domestic livestock has rendered additional thousands of acres worthless to the wild turkey. Successful restocking attempts have been made by the Texas Parks and Wildlife Department with turkey trapped from the wild. The

trapped birds are immediately released into approved restocking areas and carefully protected for at least five years following their release. Wild turkey have the ability to survive and reproduce when relocated under such conditions. In most cases, releases of pen-raised or semidomesticated turkey into the wild have been unsuccessful and quite expensive. Releasing pen-raised birds into the wild may also invite serious disease and parasite problems unless done under carefully regulated conditions such as programs carried out by the Parks and Wildlife Department.

There are several factors which should be considered before turkeys are restocked in an area. First, why aren't turkeys there now? Is there sufficient vegetation to provide cover and food? Good turkey range should have ample numbers of mature trees as well as brush and shrubs to provide food (pecans, acorns, berries, seeds) as well as cover and roosting areas. Assuming the range provides all the natural essentials, the area must also be protected from illegal hunting such as roost shooting at night. *No one should be allowed to hunt, camp or otherwise disturb turkey within one-quarter mile of a roost site.* Finally, turkey require a large annual range, often moving eight to 10 miles from winter roost sites to summer nesting areas. Food, cover and protection must, therefore, be provided over an area of several thousand acres. If an area can provide all these essentials and is within the required rainfall belt, then serious consideration might be given the possibility of restocking turkey.

Do turkey need supplemental feed?

Supplemental feeding of any wild animal is recommended only during extended periods of stress such as prolonged drought or severe winter weather. However, in order to sustain wildlife during these critical periods, the animals must know where the supplemental feed is located and be accustomed to taking it. Therefore, feed should be provided well in advance of any anticipated critical periods. Often supplemental feed is provided just before and during hunting seasons in order to "bait" turkey to a specific site to be harvested by eager hunters. It is essential that such a feeding program be continued into January and February if turkey are going to benefit from it. Turkey prefer natural food and will not take significant quantities of artificial feed unless they really need it. In most cases, it is preferable to improve or extend the turkey's natural habitat and food supply.

Although extended periods of severe weather may justify supplemental feeding in some instances, feeding programs are expensive. Feeding areas should be kept clean and the grain must not become contaminated by the birds' droppings. For this reason, feeders should be moved short distances from time to time. The feeding area should be near trees and thick brush to provide immediate escape cover from predators.

Food plots are preferable to feeding stations for turkey and other wildlife. These plots need not be large in size; two to 10 acres will provide large quantities of forage for turkey and other wildlife if it is not grazed by domestic livestock. Turkey readily eat oats, wheat, clover, vetch or rye.

Biologists in Texas and other states have worked years to obtain answers to some of the many questions which arise concerning the restoration and management of the wild turkey. Our society continues to demand more fields for food

crops; more livestock to provide meat and other products; more lakes for recreational activities; and more land for homes, schools, factories and roads. These demands may spell eventual doom for the wild turkey unless large tracts of land are preserved as wildlife habitat. Continuing research will hopefully provide the management techniques which will ensure the survival of the wild turkey in Texas.

For those landowners and sportsmen who may be interested in feeding turkeys on their land or leases, we have included diagrammatical sketches of two feeders which have proven successful in many areas of Texas. October through March is the critical time for keeping feed available to turkey. Best feeds are milo or corn chops. Landowners who wish to feed both deer and turkey from the same feeder should consider using an elevated barrel-type automatic feeder and a mixture of whole corn and milo.



Turkey Feeder 500 pound capacity

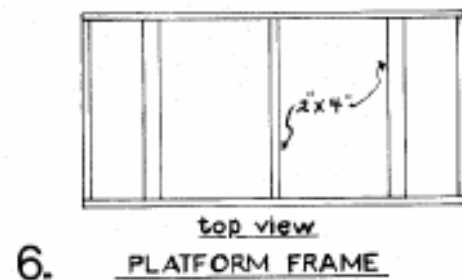
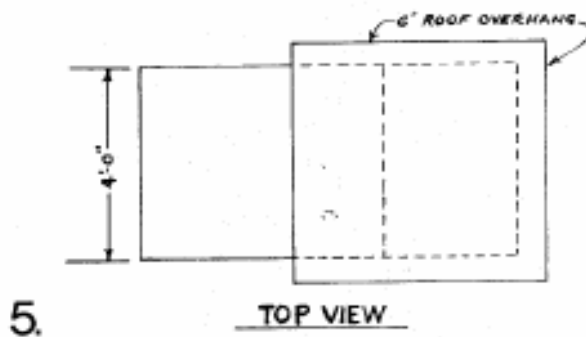
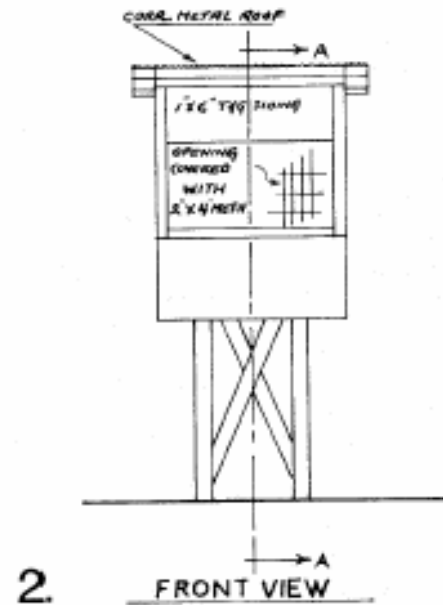
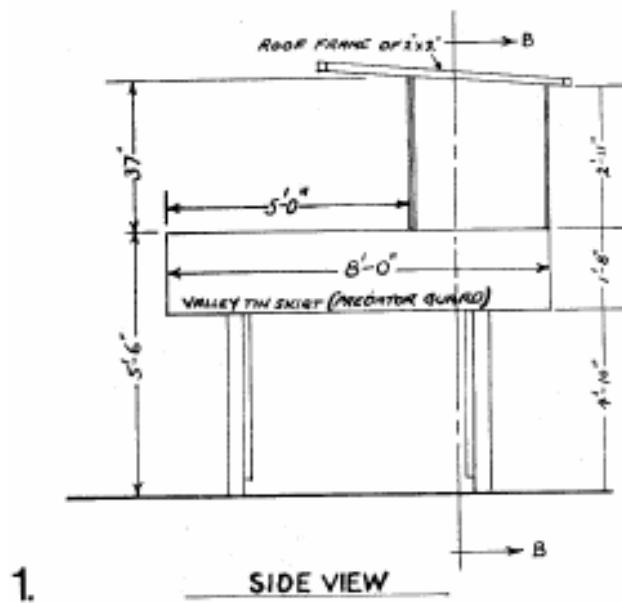

General Notes

1. Platform Covering & Exterior of Hopper of 1" x 6" T&G
2. "Weldwire" Mesh Used Over Feed Opening
3. Top of Hopper Secured By Hook & Eye at Each Side.
4. T&G Siding on Hopper Installed With Tongue Edge Up.
5. Posts Set in From Edge Of Platform To Deny Access to Predators.

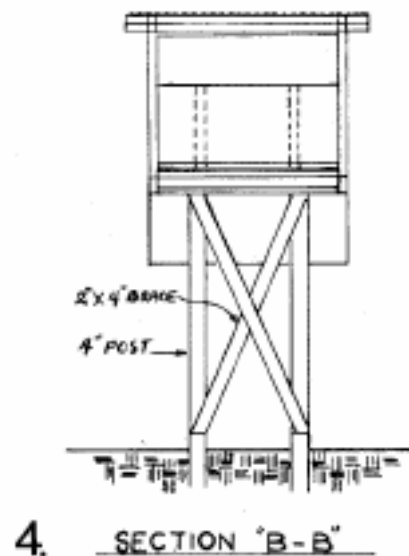
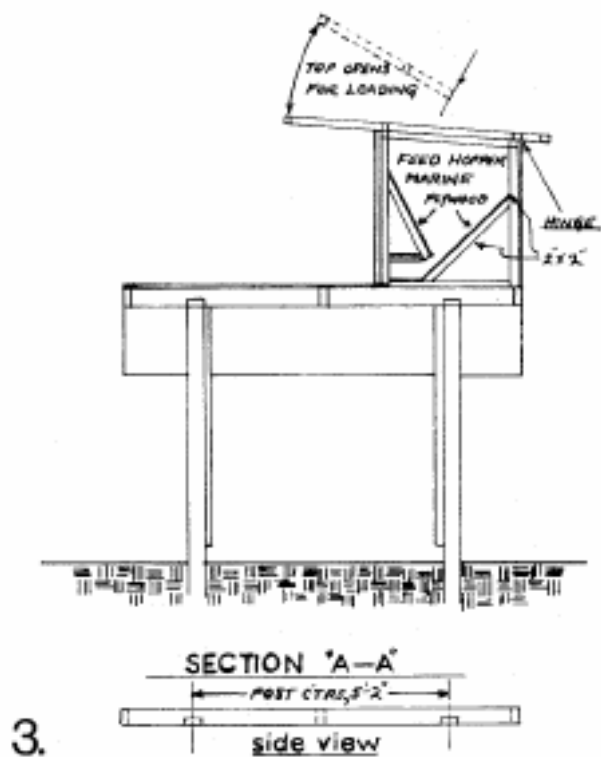

This type of feeder is being used on several wildlife management areas and on private ranches. The inset legs and valley tin around the platform practically eliminates the tremendous waste that usually accompanies the use of turkey feeders by ever-hungry raccoons.

Care should be taken not to place the feeder directly under a tree or the raccoons will soon learn to climb the tree and drop down on the feeder. While it takes a little longer for turkeys to learn to utilize this type of feeder, the savings are well worthwhile. Turkey will normally accept this feeder more readily if a few pounds of grain such as milo are scattered on the ground around the feeder at weekly intervals until turkey locate the feed in the hopper.

The materials to build this feeder cost approximately \$50.00 and if the wood is treated it will last for many years.

TURKEY FEEDER

Feeder
(55 gallon)

Inside View

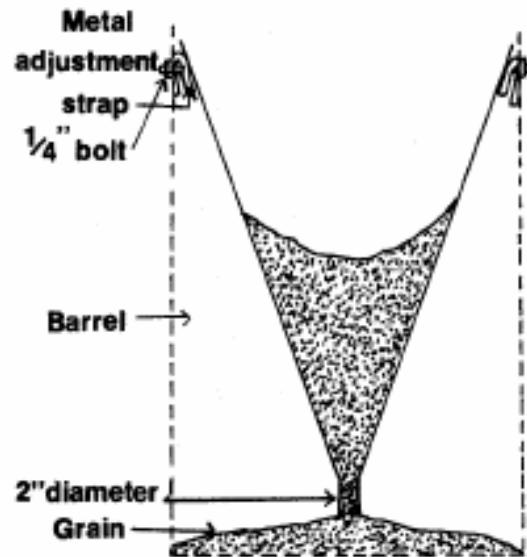
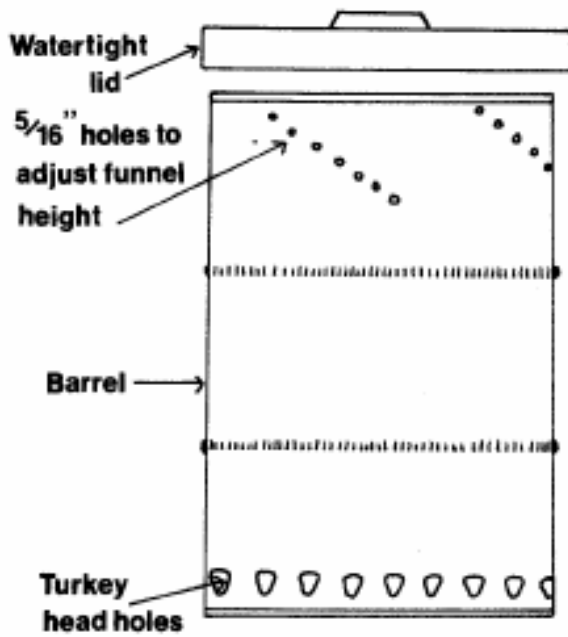

Turkey Head Holes

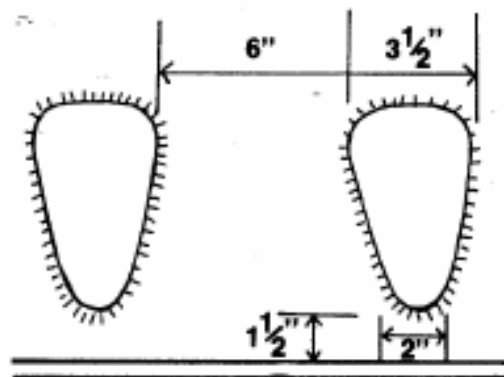

TURKEY FEEDER PLATFORM

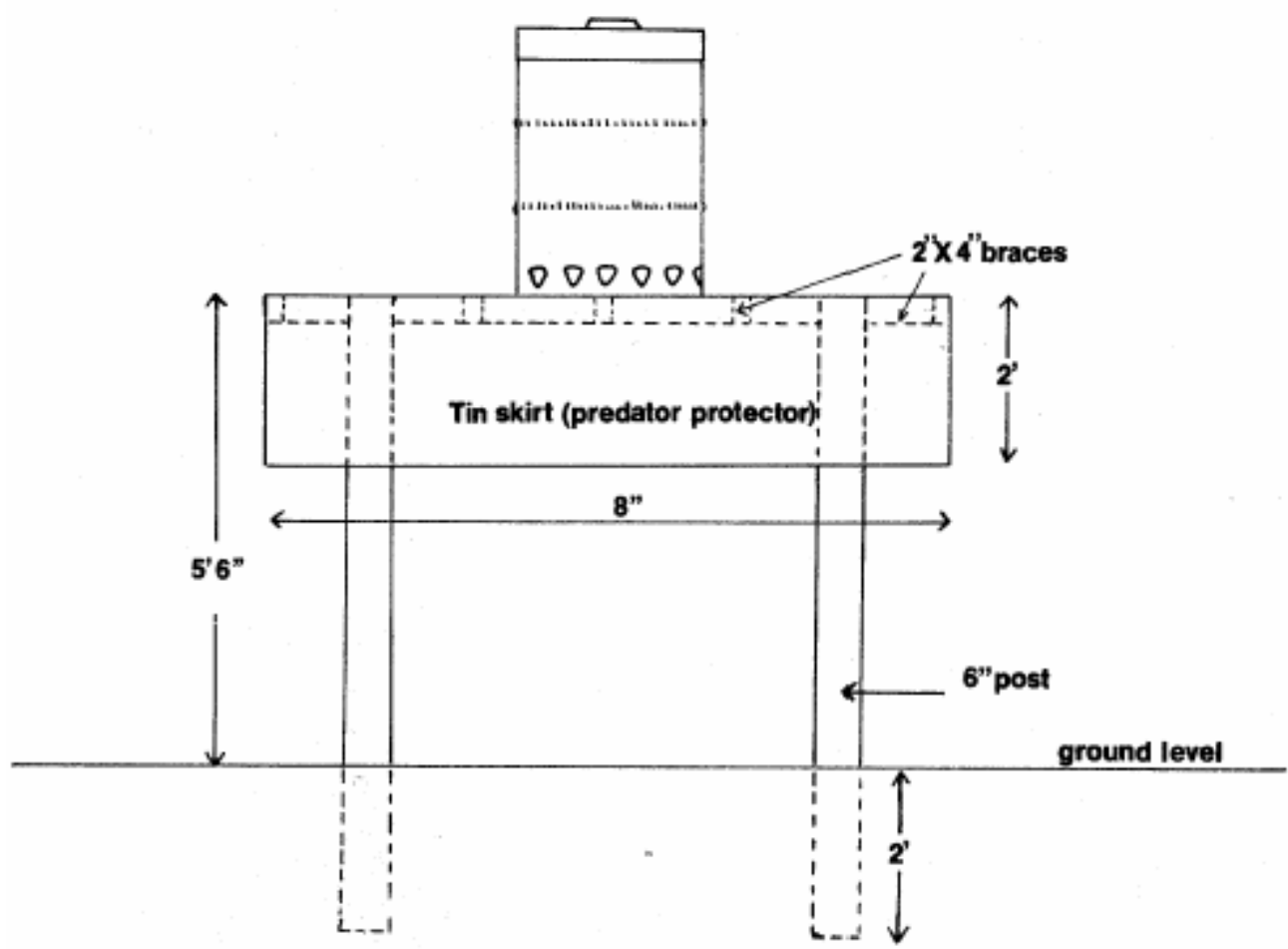

Visit the outdoors each month through the full-color pages of TEXAS PARKS & WILDLIFE

...a magazine that takes you on an outing 12 times a year. We'll bring you stories on state parks, fishing in our many freshwater lakes and saltwater bays, Texas' abundant wildlife and anything else to do with the outdoors.

It's all illustrated with some of the nation's best color photography, and at a price that's hard to beat.

You can order your subscription by calling us at 1-800-792-1112 Mon. thru Fri., between 8 A.M. and 5 P.M.

Rates:

1 year \$8
2 year \$15

Foreign 1 year \$10
Foreign 2 year \$18

(Domestic rates include APO & FPO)

TEXAS PARKS & WILDLIFE Magazine
4200 Smith School Rd.
Austin, Tx. 78744

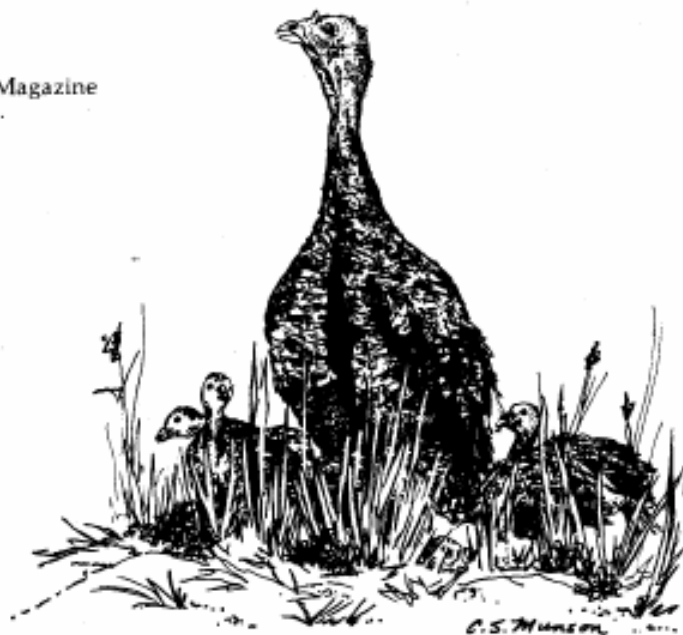

APPENDIX CC

BOBWHITE QUAIL

IN TEXAS



Habitat Needs &
Management Suggestions

by
Alfred S. Jackson
Clyde Holt
Daniel W. Lay



FOREWORD

Bobwhite quail may be found from the tip of the Panhandle to the mouth of the Rio Grande in Texas, although their principal range is considered to be from the 101st meridian eastward. Within the broad scope of this area, bobwhite's presence and abundance are dependent primarily upon the amount and quality of quail habitat which he can utilize.

Texas has more than a million hunters, and the survey conducted by the Bureau of the Census in 1960 showed that 321,000 quail hunters bagged 98 million birds. Most of these were bobwhites, and certainly this number two small game bird in Texas supplies many hours of recreation and many pounds of meat for Texas outdoorsmen.

Although climatic factors often determine the extent of bobwhite range in Texas, abnormal weather within the range may dictate the conditions upon which bob's yearly survival is dependent. Drought, floods, and other natural causes can reap a heavy toll on bobwhite populations and prove to be devastating where quail habitat is of the marginal variety. Even in high quality areas, these factors may reduce quail populations to a dangerous low. However, bobwhite is a resilient game species and his potential for reproduction permits him to make a speedy recovery, if his basic habitat requirements are maintained.

Food, water and cover are the keys to bobwhite survival. The plants providing these essentials may vary greatly from one portion of the quail range to another. Management requires that

these key plants be recognized, protected, and perhaps encouraged, if bobwhites are to be produced in huntable numbers.

The purpose of this brochure is to acquaint landowners, sportsmen and other bobwhite quail enthusiasts with some specific information which may be used to improve bobwhite's lot through management of quail habitat.

Quail can be produced on land used for the production of timber, ranching or farming, if the land operator will keep in mind that bobwhite's habitat needs must be met the year round. Bobwhite's habitat requirements may be a simple matter of protection of woody cover on prairie range; shallow discing adjoining wide fence rows on an East Texas farm; or some inexpensive food and cover plantings, with protection from grazing, in a South Texas pasture.

Knowledge of quail needs does not in itself insure bobwhite's continued welfare. This knowledge, to be helpful in wildlife management, must be applied to land-use practices found throughout the quail's range.

The basic information contained in this brochure, properly utilized, can help insure to landowners and sportsmen a continued supply of bobwhite quail. Wildlife Biologists and State Wildlife Extension Biologists with the Texas Parks and Wildlife Department are available in each region of the state to assist landowners in preparing management plans for individual tracts of land which could result in increased bobwhite numbers.

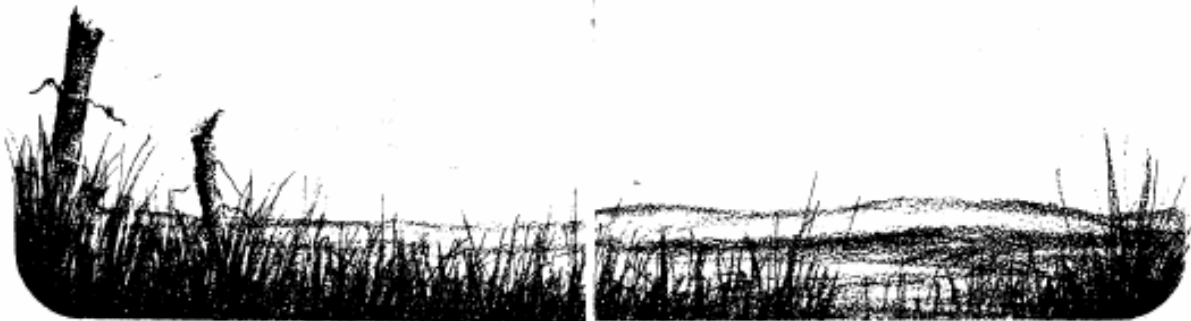

WHAT IS BOBWHITE QUAIL HABITAT?

Throughout the vastness of Texas, bobwhite habitat varies in character with the differences in soils and climate. Always, whatever the make-up, quail habitat comes down to this: a piece of ground capable of providing at least one covey with all of its life needs, season after season. Bobwhite must have a year-round adequate supply of food and reasonable protection from the hazards to his kind of living. This includes protection from enemies while feeding, resting, loafing, roosting, traveling and nesting.

QUAIL MANAGER MUST REALIZE EXACTING REQUIREMENTS

The range requirements of bobwhite quail are much more exacting than are those of any kind of domestic livestock. While ranges grazed until



they are bare are readily recognized as unsuited to bobwhites, it is less obvious to most landowners and sportsmen that the other extreme, too much thick grass, can be equally detrimental to quail habitat. The latter can be barren of available quail foods and unsuitable for quail cover.

Food and cover also must occur in a "friendly" relationship to each other if they are to comprise quail habitat. That is to say, the distance between a source of ample food and adequate cover must not be greater than bobwhites can negotiate with safety. Ideally, escape cover should be linked to food supplies with more or less continuous screening cover. The latter must not be dense enough to



prove an obstacle to the bobwhite's short-legged gait. Without a suitable space relationship, a range will not be habitable for bobwhite regardless of the quality or amount of food and cover present.

Both food and cover supply must be stable or continuously renewed during the entire year. It is not enough that food and cover be adequate for 11 months, if either is lacking during a single month. This should be an obvious fact, but it is all too often overlooked during seasonal farm and ranch operations.

WEEDS ARE ALL IMPORTANT SOURCES OF FALL AND WINTER QUAIL FOOD

Bobwhite nearly always fares well during spring and summer months. Seeds are ripening then and food supply is supplemented by a wealth of insects and green plant material. However, from the time of the first killing frost, the supply of quail food begins to diminish. All fall and winter, other birds and rodents compete with bobwhite for the summer's production of seeds. Weathering also depletes the supply.

Some staple winter foods of bobwhite quail are listed below. These species have wide distribution throughout Texas. The sportsman and landowner would do well to recognize the plants in the field and to determine which seeds are represented in the food of quail bagged during the hunting season. Seeds of some of these plants will almost always be found to predominate in the winter food of bobwhites in any part of Texas.



Doveweed—*Croton* sp.



Tick trefoil—*Desmodium* sp.

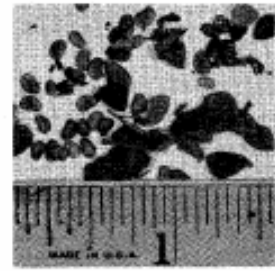

Ragweed—*Ambrosia* sp.

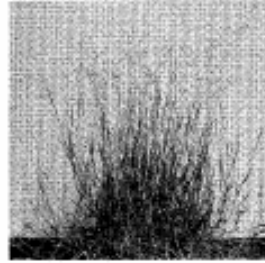
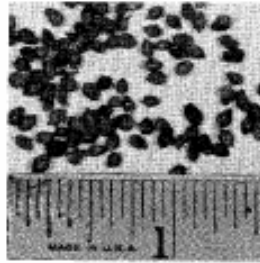

Panic grass—*Panicum* sp.

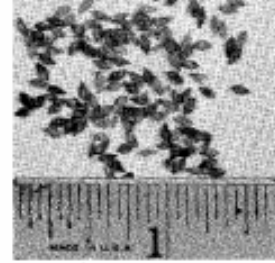

Partridge pea—*Cassia* sp.

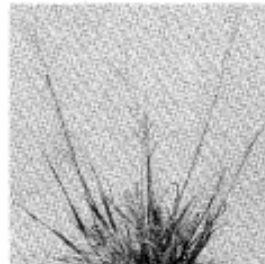
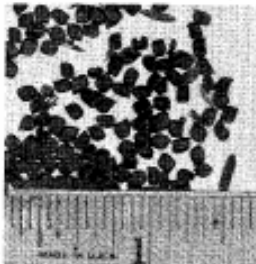

Paspalum—*Paspalum* sp.

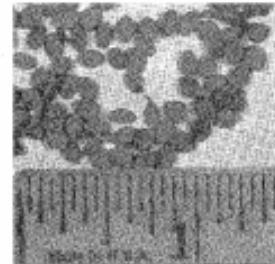

Wild bean—*Strophostyles* sp.

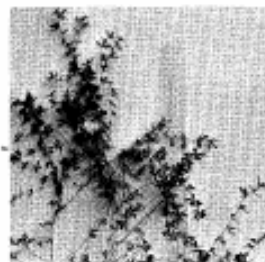
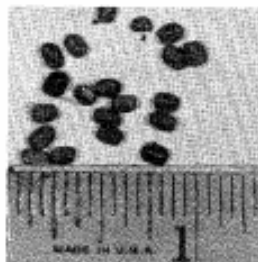

Lespedeza—*Lespedeza* sp.

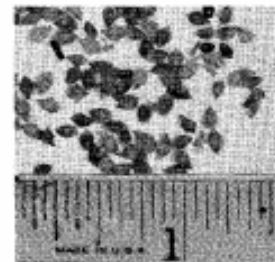

OTHER BOBWHITE FOODS

The list of plants contributing to the quail's winter diet is a long one. The number of plants represented in a series of quail craws is generally greatest at times when food supplies are critically low. When food is abundant, bobwhites, as do people, tend to eat what they like best and have least trouble finding.

A number of woody plants provide winter quail foods in the various regions of Texas. Quail readily eat the smaller acorns, such as those from post oak. To some degree, they are able to crack the larger acorns and break them into bites which can be swallowed. Mesquite beans, pine seeds, gum



elastic berries, wild grapes, French mulberries, hackberry, sumac berries and other products of woody plants occasionally are eaten by bobwhites.

Stockmen should note that grasses contribute little to food needs of bobwhites. This is because few grass seeds are large enough to provide worthwhile food. Paspalums and panic grasses are minor sources of quail food in the state as a whole, but may be important in some localities.

All farm grown grains, including corn, are acceptable to bobwhites. Where grain is left in the field, bobwhites can be expected to utilize it to an extent controlled by the cover pattern of fence rows and pasture edges.

In general, however, it can be safely said that weeds are the most widely distributed source of quail food and weeds respond most reliably to management of quail habitat.

FUNCTIONS OF COVER

The bobwhite cannot live long without cover, just as he cannot live without food. In a sense, the bobwhite's need for cover is a specialized one. However, because the uses and functions of different types of quail cover overlap to some degree, and because external factors such as weather, predation and hunting pressure are variable, bobwhite can adjust somewhat better to cover deficiency than to a shortage of food. So far, no one has been able to draw an exact line where the habitat becomes immediately untenable because of too little or too much cover.

On the other hand, bobwhites may endure a shortage of cover for a time, but the population trend will be downward unless cover deficiency is quickly corrected. The quail manager must aim not only at good cover; he must insure that the cover will not deteriorate under influence of winter storms or livestock use. As pointed out earlier, a month of cover failure can be as disastrous to a covey as can a 12-month lack.



Bobwhites need these types of cover: screening overhead cover for security while feeding and traveling, woody "tangled" cover to which the bobwhite can resort for immediate escape from an

enemy, a "living room" type of cover for dusting or resting, and nesting cover. Roosting cover is also needed; however, if the other types are present it is almost certain that roosting conditions will be no problem. Bobwhites roost on the ground, in grassy or weedy glades, in old reverting fields, on grassy hillsides and in openings in timbered areas. The location of roosts is partly a matter of weather and partly of choosing a site where food will be nearby for the early morning feeding period.

BOBWHITE COVER TAKES MANY FORMS

Types of cover having the above requisites are difficult to describe because each may have the qualities needed, yet vary in composition under influences of soils, climates and land uses. Thus, in the upper Panhandle sandhills, excellent cover may consist of sagebrush and tall grasses (feeding, roosting, nesting) and sumac and wild plum motts (escape, resting, dusting).

At the other side of the state, motts of mesquite, granjeno, guajillo, black brush, white brush or prickly pear may serve the needs for woody cover in grasslands.

On the West Texas Rolling Plains, mesquite brush is the principal woody cover. To serve as stable and safe woody cover, it must be bolstered at ground level by a stand of herbaceous cover. The tree itself is too open but, under conservative range use, it often serves as a living fence to discourage grazing and protect the needed understory of weeds and grasses.

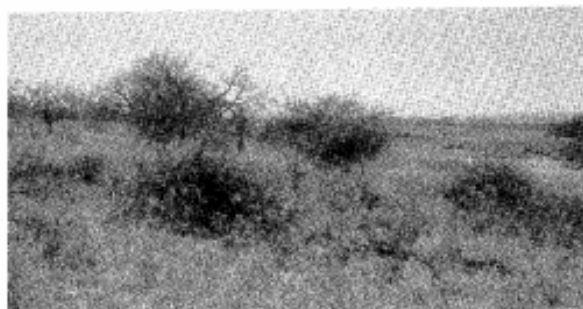

The Grand Prairie of central Texas is threaded with countless creeks whose normally dry tributaries finger out into grasslands and offer examples of almost ideal bobwhite cover; trees, thickets, motts and travel lanes of low bushes and vines form cover patterns of infinite variety.





Eastward, where rainfall is greater, quail cover becomes less of a problem. In forest edges, field fence rows and pasture margins, examples of good quail cover in abundance still can be found. In this part of Texas some of the more important cover plants are yaupon, wild grapes, rattan, wild plums, sumacs, blackberry and greenbrier. In general, the absence of cover is not a problem to the quail manager in east Texas. The problem lies in preservation of cover in a proper spatial relationship to natural foods.

In the Rolling Plains, a continuing program directed at brush eradication, if successful, will adversely effect bobwhite populations. On the other hand, sparing a strip of mesquite or shinoak 50 to 100 feet in width, and at intervals of one fourth mile would accommodate the cover needs of bobwhite, provided that a food supply was adequate and accessible.

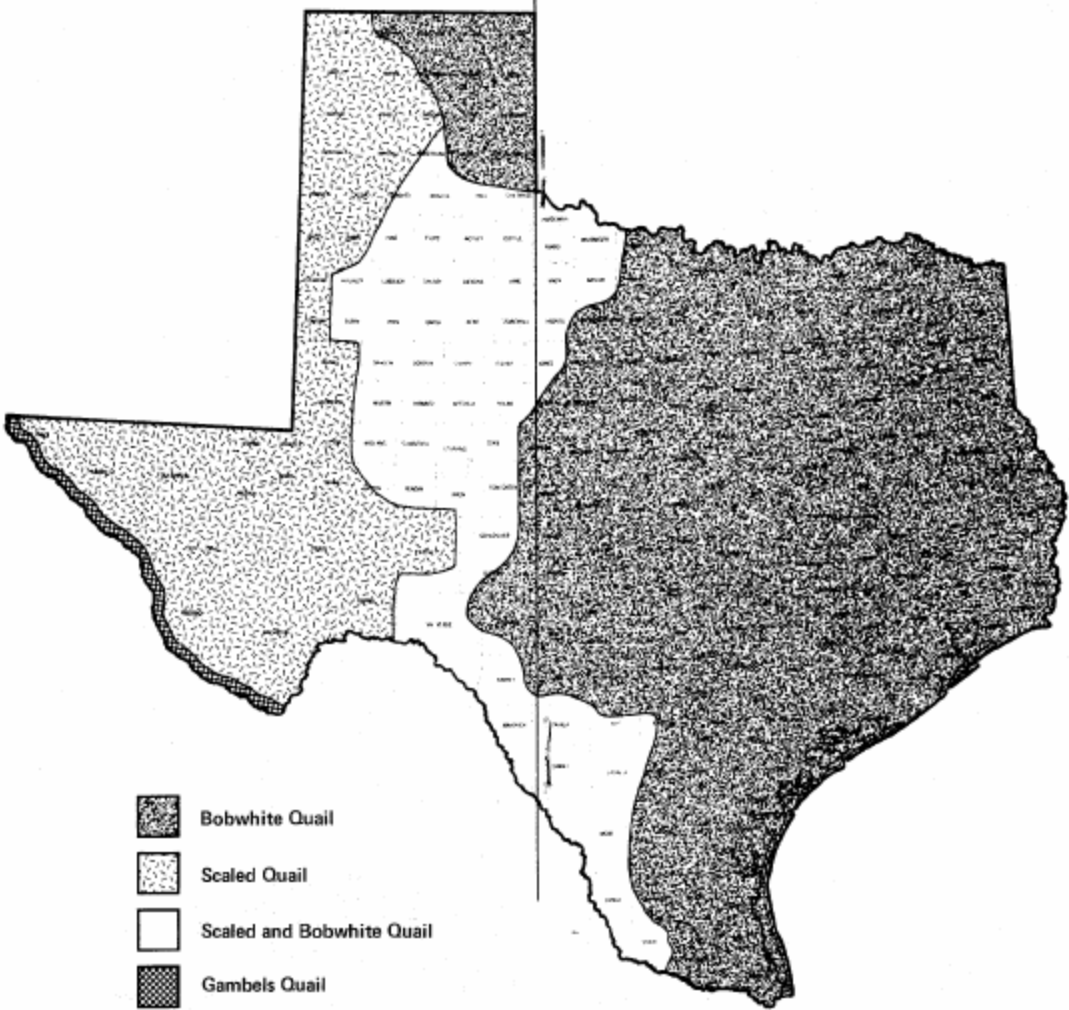
Wherever he lives or hunts, the would-be bobwhite manager should learn about cover requirements for bobwhite quail by studying ranges where coveys are located every year.





-  Bobwhite Quail
-  Scaled Quail
-  Scaled and Bobwhite Quail
-  Gambels Quail

**AVOID THESE MISTAKES IF YOU WANT
HABITAT MANAGEMENT TO BE
SUCCESSFUL**

Bobwhite requires acreage out of all proportion to his small size. The maximum population attainable is believed to be one bobwhite per acre for any large block of range such as a farm or ranch.

Because the average covey consists of from 10 to 15 bobwhites, a block of 15 acres will seldom support more than one covey. This occurs only under ideal conditions, and seldom lasts more than a year. Thus, the acreage requirements of a bobwhite covey are equal to, or greater than, the acres required per cow over most of the native grazing ranges in Texas.



Do not expect a plum thicket or grapevine to hold a covey of bobwhites if it is all the habitat in sight.

It takes time to develop bobwhite habitat. Sources of natural food cannot be developed in less than one growing season. Cover, if improvement necessitates plantings, will be difficult to develop within less than four or five years. The improvement of existing cover takes less time and, if good cover is present, it may only need matching with a food supply. This again requires as much time as it takes to grow a food supply,

or one growing season. Quail management is not a spur-of-the-moment project to be undertaken today and abandoned tomorrow.



Expect no success with bobwhites until their habitat is completed and "working".

Success of food and cover plantings depends upon the amount of preparation of the seed bed and care given young plantings. Nursery stock of woody transplants are sure to fail if planted on raw soil and left to compete with natural growth of weeds and grasses. For all food plantings, a well tilled seed bed is essential. Rows of tree or shrub transplants need a side dressing with a disc harrow or cultivator several times each season during the first three or four years.



It takes work to develop habitat from plantings.

BY-PRODUCT MANAGEMENT OF HABITAT

(Resulting From Good Land Management Practices Used Primarily for Other Purposes)

This is the most practical and economical type of quail habitat management because it serves two purposes at once.

FOOD



1. Almost any soil disturbance results in growth of the weeds which produce quail food. This principle can be utilized anywhere by controlled burning, plowing, discing, fallowing or grazing. All these practices should be carried out after the end of winter but before spring growth gets underway.



2. Conservative grazing pressure results in sustained production of food-producing plants and, at the same time, insures preservation of needed ground cover.



3. Discing, contouring or pitting rangelands brings on weed successions productive of quail food.

COVER



1. Protection of gullies to retard run-off helps develop good ground cover.
 - a. Where any pasturing of a field is done, gullies should be fenced out.

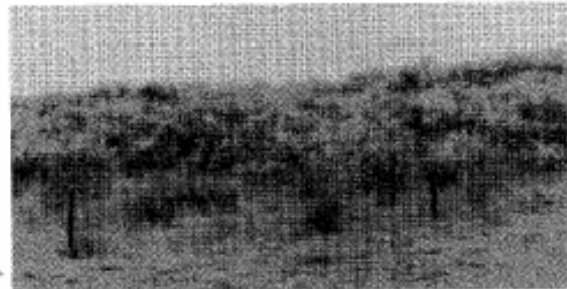

- b. Erosion often can be retarded or stopped with "thickety" plantings of woody cover in selected places.



2. Planting windbreaks or adding to existing windbreaks provides good escape cover.

- a. These should be fenced to preserve ground cover.
- b. Suitable shrub and tree species: Russian olive, black locust, eastern red cedar, desert willow, sumac and other drought resistant species are best for drier areas of Texas.
- c. Shrubbery species can be fitted into existing windbreaks and hedges which are too open.
- d. Tree and shrub plantings require tillage for at least three years. Thereafter, weeds and grasses improve this woody growth as bobwhite habitat.
- e. After woody plantings are established, weedy growth can be promoted by a single disking of the middles during March or April.



3. Planting oats or other temporary cover crops adjacent to woody cover adds to the value of cover and provides needed green food in winter.



4. Stubble left in the close vicinity of windbreaks or other woody cover adds to value of bobwhite habitat (this is especially effective in winter if there is combine waste or shocked grain left in the field).



5. Deferred or rotated grazing results in carry-over of dead grasses essential for nesting cover.



6. Use of spreader dams on livestock ranges retards run-off; it also results in good ground cover.

HABITAT MANAGEMENT PRIMARILY FOR IMPROVING CARRYING CAPACITY OF LAND

FOOD DEVELOPMENT

Any practice which sets back plant succession, including use of grazing animals within conservative limits, is beneficial to bobwhite quail if adequate cover is present.

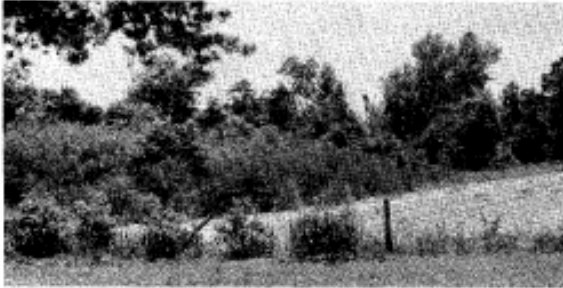

1. It is wise to develop native food by plowing, discing or burning. March and early April are the best times.
 - a. Associate foods with existing woody cover, preferably in odd corners, brushy fence rows and hedges, alluvial spots along creek courses and edges of timbered plots.
 - b. If none of the weeds listed on pages 3 and 4 emerge, it will be necessary to plant or sow locally adapted species which will provide known quail foods. These might include sorghum, alnum millet, soy beans or annual lespedeza.



2. Leaving several rows of standing field grains adjacent to windbreak plantings or brushy fence rows is an effective practice under favorable conditions. This method has the disadvantage of such food supplies attracting blackbirds and rodents which quickly consume the grain. In providing such plantings for quail food, it is well to remember that it takes a strip approximately eight feet wide and a mile long to equal an acre. Be guided accordingly and leave enough for all feathered pensioners.

COVER DEVELOPMENT

In situations where native cover is inadequate or has been destroyed, several improvements are possible.



1. Plant native or exotic shrubs proven in the locality and protect them from livestock.
 - a. For bobwhite utilization as escape or resting cover, use edge plantings along food supply or tie together scattered natural covers with hedge plantings.
 - b. Plan cover plantings to front the maximum feeding area.
 - c. Some desirable species, depending on location, are eastern red cedar, desert willow, Russian mulberry, Russian olive, squawbush, yaupon, rattan, grape, greenbrier, granjeno and prickly pear.

- d. Try for irregular or natural appearing patterns of coverts.



2. Where trees support grapevines but are too open at ground level to serve as quail cover, cut half through the tree a few feet above the ground and push it over, thus bringing living vines closer to earth.

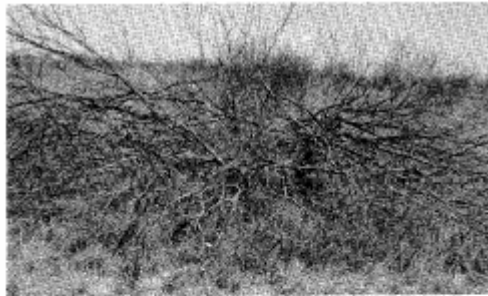

3. Mesquite brush ranges can be improved in respect to cover by half-cutting multiple trunks near ground level, allowing tips of limbs to touch the ground and serve as protection for ground cover. This method will be useless without the type of range management resulting in production of quail foods.

Before making any selection of food and cover plants, it might be profitable to ask the Texas Game and Fish Commission for advice and guidance about habitat problems.

Visit the outdoors each month through the full-color pages of

TEXAS PARKS & WILDLIFE

...a magazine that takes you on an outing 12 times a year. We'll bring you stories on state parks, fishing in our many freshwater lakes and saltwater bays, Texas' abundant wildlife and anything else to do with the outdoors.

It's all illustrated with some of the nation's best color photography, and at a price that's hard to beat.

Complete the form below and mail it with your check or money order, or we'll bill you later.

M

Name _____

Address _____

City & State _____

ZIP _____

1 year \$10 2 years \$18 3 years \$26
 Foreign Foreign Foreign
 1 year \$12 2 years \$21 3 years \$30

Payment enclosed Bill me later

Prices subject to change without notice.

For faster service call toll-free 1-800-937-9393



Texas Parks and Wildlife Department
 4200 Smith School Road
 Austin, Texas 78744

Dispersal of this publication conforms with Texas State Documents Depository Law, and it is available at Texas State Publications Clearinghouse and Texas Depository Libraries.

PWD-BK-7100-37-12/90

APPENDIX DD



Texas Parks & Wildlife Department
4200 Smith School Road
Austin, Texas 78744

Contribution of Federal Aid Project
W-127-R



PWD-BK-7100-199-4/92

Dispersal of this publication conforms with Texas State Documents Depository Law, and it is available at Texas State Publications Clearinghouse and/or Texas Depository Libraries.

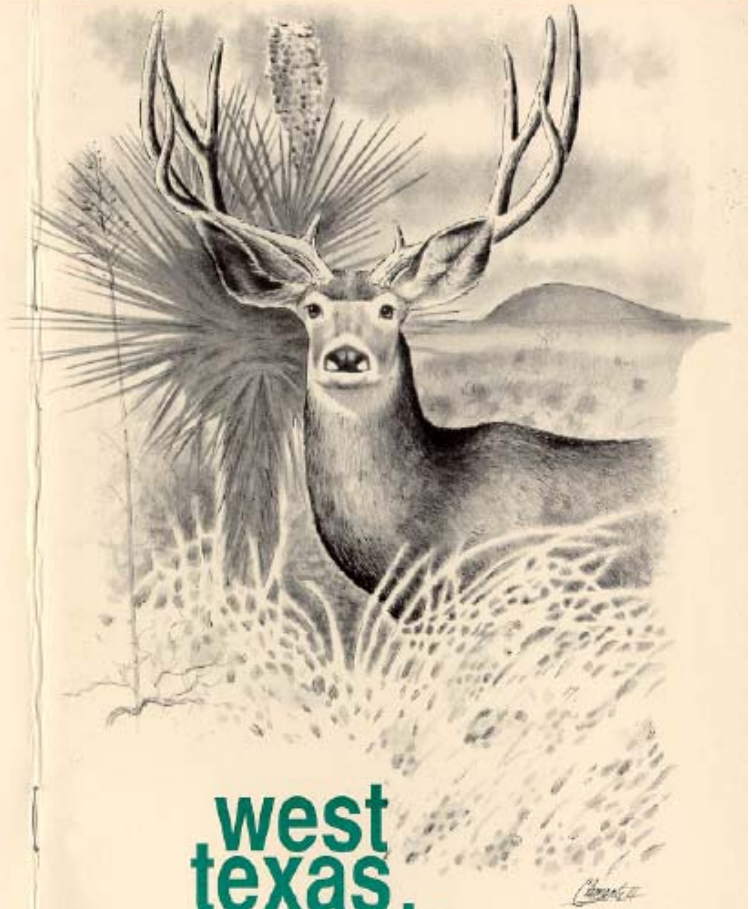

west
texas
mule
deer

west texas mule deer

by
Timothy L. Bone
and
William B. Russ

West Texas Mule Deer

by
Timothy L. Bone and William B. Russ

When the subject of deer is brought up, most Texans think of white-tailed deer. This is natural because white-tailed deer are by far the most common species of deer in Texas. Many citizens are not aware that another species of deer lives within the boundaries of their state.

The mountains and canyons of west Texas provide habitat for the desert mule deer, one of the most important big game species that the state has to offer. Established populations of desert mule deer are found in the Trans-Pecos and Panhandle regions of Texas.

Many ranchers have discovered that demand for mule deer hunting is high. Among the game species in Texas, mule deer rank 10th in hunting popularity. Hunting lease revenue generated from this game species has become an important component of ranch income.

Aesthetically, mule deer are a popular part of the natural environment in the western portion of the state. Visitors frequently stop in at Texas Parks and Wildlife Department field offices to ask biologists and game wardens where they can go to observe and photograph mule deer.

Research and management projects concerning the mule deer and its habitat requirements are conducted by wildlife biologists of the Texas Parks and Wildlife Department, federal agencies, and many universities in Texas. Research activities by wildlife biologists of the Texas Parks and Wildlife Department are 75 percent funded from federal excise taxes on firearms and ammunition. Research activities are also conducted on National Parks and private ranches.

The Texas Parks and Wildlife Department game warden field force is responsible to provide law enforcement services to protect the mule deer resource. Mule deer occur on four Department owned wildlife management areas.

Interest in mule deer is high. Biologists and game wardens in the western part of the state are often asked questions about desert mule deer. Following are some of most frequently asked questions about desert mule deer in Texas.



west texas
mule deer 2

How many kinds of mule deer are there in Texas?

Although the range of the Rocky Mountain mule deer (*Odocoileus hemionus hemionus*) may extend into the northwest Panhandle, virtually all mule deer in Texas are of the smaller subspecies (*O. hemionus crooki*), the Desert Mule Deer.

Where are mule deer located in Texas?

Desert mule deer occur in the Trans-Pecos, Edwards Plateau, High Plains, and Rolling Plains Ecological Regions (Figure 1). The Trans-Pecos population is largely continuous. The Edwards Plateau population is adjacent to the Trans-Pecos population and is confined to the Pecos River drainage. Mule deer in the Panhandle are found in isolated populations associated with the breaks and tributaries of the Brazos, Canadian, and Red Rivers and the caprock escarpment.

How many mule deer are there in Texas?

The mule deer population estimate has fluctuated between 150,000-250,000 during the last ten years. Approximately 90 percent of the mule deer in Texas occur in the Trans-Pecos and western Edwards Plateau.

west texas
mule deer 3

Figure 1 Distribution of Desert Mule Deer in Texas—1991

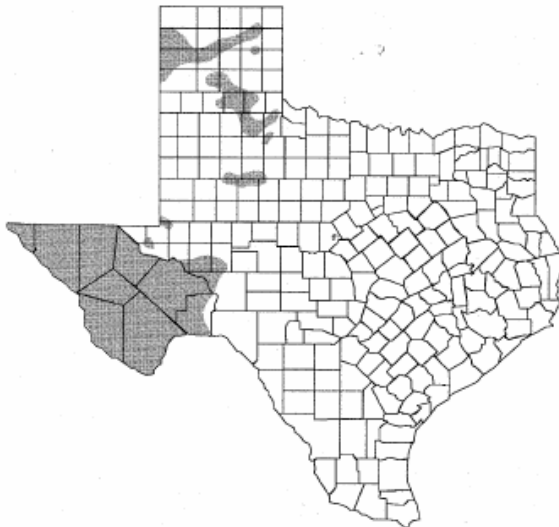

west texas
mule deer 4

Do Texas mule deer migrate?

Unlike Rocky Mountain mule deer, desert mule deer are not considered to be migratory. Desert mule deer may shift their home ranges in response to the availability of water and forage or the presence of mountain lions. The home range for most Texas mule deer does not exceed 2 square miles.

Do desert mule deer gather in large herds like Rocky Mountain mule deer?

Desert mule deer in the Trans-Pecos have been observed to form large groups in areas where the population densities are high. Herds of 20-40 deer may form during the January-March period.



west texas
mule deer 5

What is the best method of counting mule deer?

Daylight ground counts and aerial counts give the best data for fawn survival and adult sex ratios. Spotlight counts provide information on mule deer density.

What do mule deer eat?

Mule deer primarily eat browse (leaves, twigs, and young shoots of woody plants and vines) and forbs (weeds and other broad-leaved flowering plants). They eat some grass but only when it is green and succulent. Sheep, goats, and exotic big game compete directly with mule deer for preferred foods.

The following plants are examples of some Texas native desert mule deer foods that are readily taken when they are available.

Browse: lechuguilla, sotol, prickly pear pads and fruit, guayacan, oak leaves and acorns, mesquite beans and leaves, acacias, kidney-wood, juniper, condalias, mountain mahogany, silktassel, sumac species, and sand sagebrush.

Grasses: rescue grass, Texas wintergrass, fall witchgrass, panic grass, grama grasses, sedges and rushes.

Forbs: euphorbias, daleas, filaree, bladderpod, bluet, wild onion and wild mercury, mendora, lespedezas, vetches, carelessweed, partridge peas, and engleman daisy.

When is the most stressful period on mule deer?

The late winter period (mid-January through mid-March) is the most stressful for mule deer because of low forage availability. Adequate forage is usually available during spring and fall seasons.

Do mule deer need to drink water every day?

Desert mule deer can survive without drinking water every day. However, a lack of adequate drinking water effects reproduction and body condition. Constructing and adapting water facilities for wildlife use is an effective way to enhance wildlife populations and distribution in areas with limited surface water.

Can the age of a mule deer be determined?

Deer age is determined by tooth replacement and wear of the premolars and molars of the lower jaw. Unlike sheep, deer cannot be aged by their front teeth. Mule deer cannot be aged by antler characteristics.

How can mule deer and white-tailed deer be distinguished?

Mule deer have forked antler beams, larger ears, a black tipped tail, and a metatarsal gland approximately four inches long.

White-tailed deer usually have major antler points coming off a continuous main beam, smaller ears, a long broad tail that is white underneath, and a small circular metatarsal gland (Figure 2).

Mule deer usually run with the tail held down. White-tailed deer tend to run with the tail held up. Mule deer often escape in bounding leaps when they are frightened, compared to the white-tailed deer's more traditional running gait.

Figure 2 Morphological differences between mule and white-tailed deer.

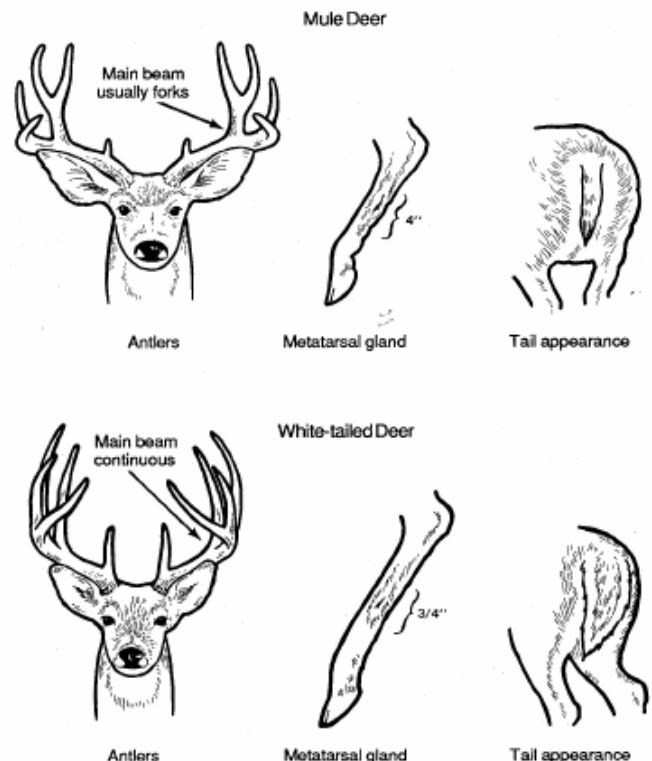

Can mule deer and white-tailed deer interbreed?

Yes, both types of parental matings have been documented (i.e., mule deer buck x white-tailed doe and mule deer doe x white-tailed buck). Hybrids can be recognized by the size of the metatarsal gland that is located on the outside of the rear leg between the hock and hoof. The metatarsal gland is typically about $\frac{3}{4}$ inch long in white-tails and about 4 inches long in mule deer. Hybrids tend to have metatarsal glands about 2 inches long.

Will white-tailed deer "drive out" the mule deer?

White-tail deer do not physically "drive out" mule deer. White-tailed deer have expanded their range and population densities into some areas that were once the sole domain of mule deer. The expansion of white-tailed deer range appears to be correlated with an increase in brush density over the last 25 years. As brush density increases, the habitat becomes more suitable for white-tailed deer and less desirable for mule deer. When occupying the same area the two species tend to segregate themselves as mule deer prefer the rougher canyons and breaks while white-tailed deer are more common in the brushy draws.

west texas
mule deer 12

What is a good buck to doe ratio?

The proper buck-doe ratio depends on overall herd numbers. Fawn production and survival is often low in a desert environment. A 1:3 ratio is desirable where the population is stable and within range carrying capacity. In areas where natural mortality is high and deer densities are low, more does may be necessary to maintain the population.

When is the breeding season?

The mule deer breeding season in Texas extends from mid-November through mid-February with the peak occurring in late-December. The gestation period is about seven months. Therefore, most fawns are born in July and August.



west texas
mule deer 13

Do doe mule deer always have twin fawns?

No. Mule deer does generally breed the first time at the age of two and give birth to a single fawn. Older does may produce twins when forage conditions are adequate.

Should spike bucks be harvested to increase the number of trophy bucks in the herd?

Deer living in a desert environment are typically on a lower nutritional plane than those from a higher rainfall zone. Spike bucks are products of youth and/or poor nutrition and/or poor genetics. Preliminary results of ongoing research indicate that most bucks that were spike antlered as yearlings will produce desirable antler growth as age increases. Culling of yearling spike mule deer should be approached with caution.

west texas
mule deer 14

When do mule deer bucks reach their greatest antler potential?

Mule deer age and antler data collected during the hunting season indicates that antler characteristics continue to improve through 7.5 years of age. If increased antler size is a management goal, then the majority of harvested bucks should be at least 5.5 years old.

Has the length of the hunting season resulted in over-harvest of mule deer bucks?

No. The percentage of bucks in the Trans-Pecos mule deer herd that have been removed by hunters has remained below 11 percent for the last 10 years with both 9-day and 16-day season lengths.



west texas
mule deer 15

Should supplemental feed be provided to mule deer?

Providing additional feed may improve antler growth, reproduction, and overwinter survival. However, feeding programs are expensive and may be cost-prohibitive for most landowners. The best way to provide proper nutrition for deer is through good range and domestic livestock management practices. If a supplemental feeding program is contemplated, contact your local biologist.

Does the Texas Parks and Wildlife Department restock mule deer?

The deer trapping and restocking program was initiated in 1938 by the Game, Fish and Oyster Commission, predecessor of the Texas Parks and Wildlife Department and continues to the present. Restocking of mule deer is done only in approved areas judged as potentially good mule deer habitat that presently has no broodstock.

west texas
mule deer 16

What can I do to increase mule deer numbers and quality?

1. Learn the habitat requirements of mule deer and become familiar with the preferred mule deer foods.
2. Learn proper range and livestock management practices and their relationship to wildlife populations.
3. Obey state laws and rules established by landowners. Do not abuse the land on which you hunt or trespass where you do not have permission.
4. Landowners and hunters can provide a significant service to the game management programs of Texas by completely and accurately providing harvest data. Accurate harvest information is vital to the formulation of effective hunting regulations, whether it is solicited by mail questionnaire or in person by biologists in the field, at check stations or cold storage facilities. These regulations will allow the maximum harvest of surplus animals without endangering the broodstock necessary to replenish those populations.



west texas
mule deer 17

To obtain assistance with mule deer management, contact the nearest Texas Parks and Wildlife Department Technical Guidance Biologist. Technical Guidance Biologists serving West Texas are listed below:

Ruben Cantu
1800 West Hwy. 90
Alpine, Texas 79830
(915) 837-5609

Gene Miller
3409 South Georgia, Suite 25
Amarillo, Texas 79109
(806) 353-3141

Fielding Harwell
309 Sidney Baker So.
Kerrville, Texas 78028
(512) 896-2500

Tommy Hailey
Ivan Star Route, Box 67
Breckenridge, Texas 76024
(817) 362-4463

APPENDIX EE

T EXAS P RONGHORNS



Texas Parks & Wildlife Department
4200 Smith School Road
Austin, Texas 78744

Fisheries & Wildlife Division
Wildlife Section
1991

Federal Aid Report Series No. 29
Contribution of Federal Aid Project
W-127-R



This publication was funded by sportsmen's dollars derived from the sale of hunting licenses and by federal excise taxes on sporting arms and ammunition as authorized by the Pittman-Robertson Act, Federal Aid in Wildlife Restoration.

PWD-BK-7100-46-10/91

Disposition of this publication conforms with Texas State Documents Depository Law, and it is available at Texas State Publications Clearinghouse and/or Texas Depository Libraries.

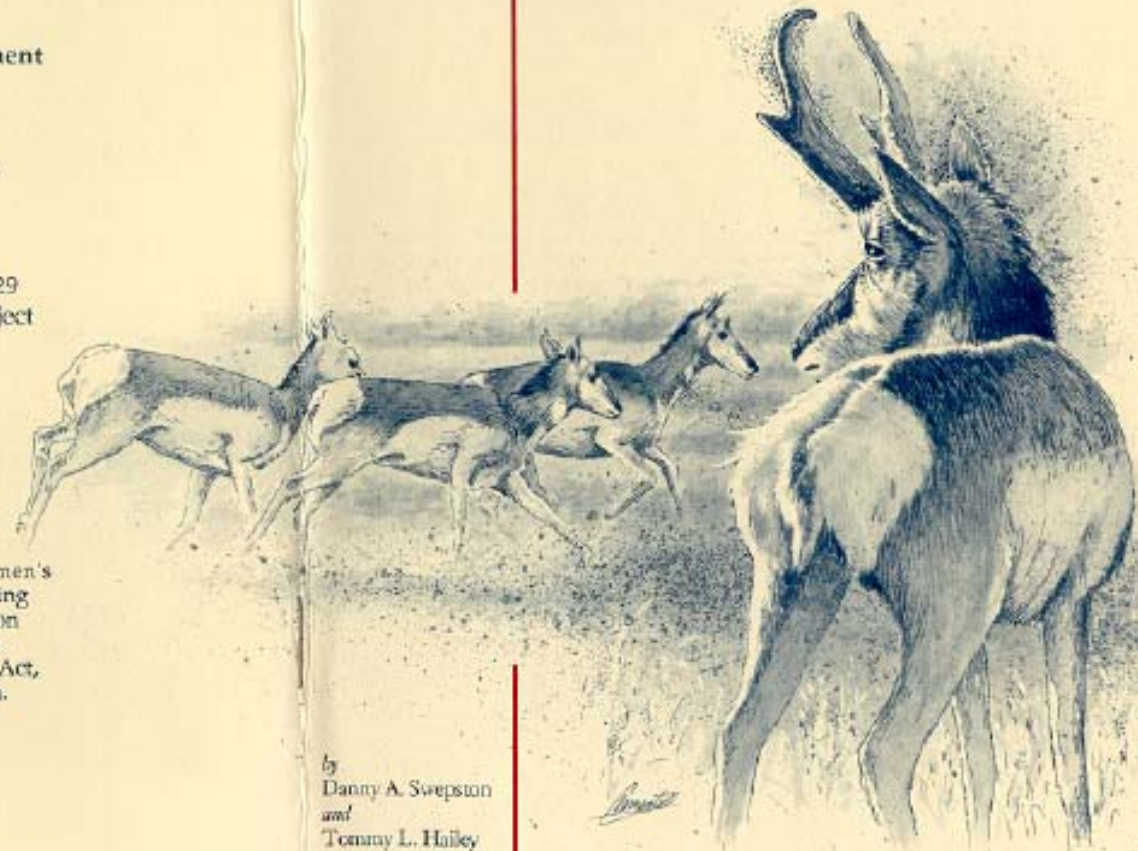

by
Danny A. Swepton
and
Tommy L. Hailey

TEXAS PRONGHORNS

By
Danny A. Swepston
and
Tommy L. Hailey



Designed, Illustrated and Printed by
CFO Division
Texas Parks & Wildlife Department

TEXAS PRONGHORNS

by
Danny A. Swepston
and
Tommy L. Hailey

Life History

The pronghorn antelope (*Antilocapra americana*) occurs only in North America. There are five sub-species of pronghorn, two of which occur in Texas (*A. a. americana*) and (*A. a. mexicana*).

Males are distinguished from females by the presence of a dark triangular-shaped cheek patch at the corner of the jaw that is lacking in females. This mark can be used to identify sex even in young antelope. Pronghorns have a tan coloration on the upper portions of their bodies with white on the face, chest, stomach and rump. The white rump patch is highly visible, and often reveals their location to observers at great distances.

Both sexes generally have horns although some females will not. Ordinarily the horns on a doe are seldom over 3 to 4 inches long. Horns on pronghorns are a mass of fused hairs which form over a bony core and are shed each year in late October and early November. Bucks with horns over 15 inches long are considered trophies.

A mature buck stands about three feet high at the shoulder and weighs about 92 pounds. The largest males in Texas rarely exceed 110 pounds. Adult females average 84 pounds. Field dressed weights are about 25 percent less.

Pronghorn antelope are adapted to survive on wide open plains. Their eyesight is so acute they can spot objects at distances that would be undetectable to the human eye without binoculars. Their eyes protrude from the head in such a way as to afford them a very broad field of vision. This exceptional vision plus their ability to reach speeds of up to 45 miles per hour are their main defenses against predators.

The breeding season in Texas occurs from mid-August through October. Female antelope usually breed the first time when 16 to 17 months of age. The gestation period is approximately 8 months (252 days) with the peak of fawning occurring between mid-May to early June. Females in excellent condition will normally have twins, but twinning is less prevalent in does producing their first fawn. Newborn antelope fawns weigh 4 to 8 pounds at birth. For the first few days the fawns are hidden, with the mother remaining nearby. The fawn will normally nurse three times a day and depends on the mother's milk for about two months before it begins to graze along with the rest of the herd. Under favorable conditions, pronghorn populations can increase rapidly, but fawn mortality is usually high. Male and female fawns are born in approximately equal numbers. Pronghorns seldom live more than nine years under natural conditions.

Because antelope populations are generally located out of the public eye, few people are aware of the basic needs of the pronghorn and how they are managed. Following are some of the more common questions asked about pronghorns in Texas.

How many antelope were there in Texas?

What is the current population?

Prior to European settlement of Texas, antelope ranged over all of Texas west of the 97th meridian (Figure 1). At the start of the 20th century antelope occurred as far north as Henrietta in northern Texas, and as far east as Alice in the southern part of the state. They reached their greatest densities in the Trans-Pecos and Panhandle Regions with numbers said to be comparable only to that of buffalo that were estimated to be in excess of several million head. Human settlement of the central and western portions of the state resulted in overgrazing of grasslands by domestic livestock, uncontrolled hunting and extensive cultivation of prairie habitat that led to a drastic decline both in the number and distribution of antelopes. The pronghorn hunting season was closed by the Texas Legislature in 1924; however, continued illegal hunting and loss of habitat prevented the herds from increasing. The first comprehensive survey of pronghorns in the state was made in 1924 and showed a population of 2,407; of which 692 occurred in the Trans-Pecos. Isolated herds of antelope were found in the Lower Plains and Panhandle counties, with a small herd persisting in Jim Hogg county in south Texas. The population in recent years (1977-1990) has varied from 12,000 to 26,870 and averages 18,500. About 70 percent of the pronghorns occur in the Trans-Pecos, 20 percent in the Panhandle and 10 percent in the Lower Plains (Figure 1).

Figure 1

Former Distribution of Pronghorn Antelope In Texas

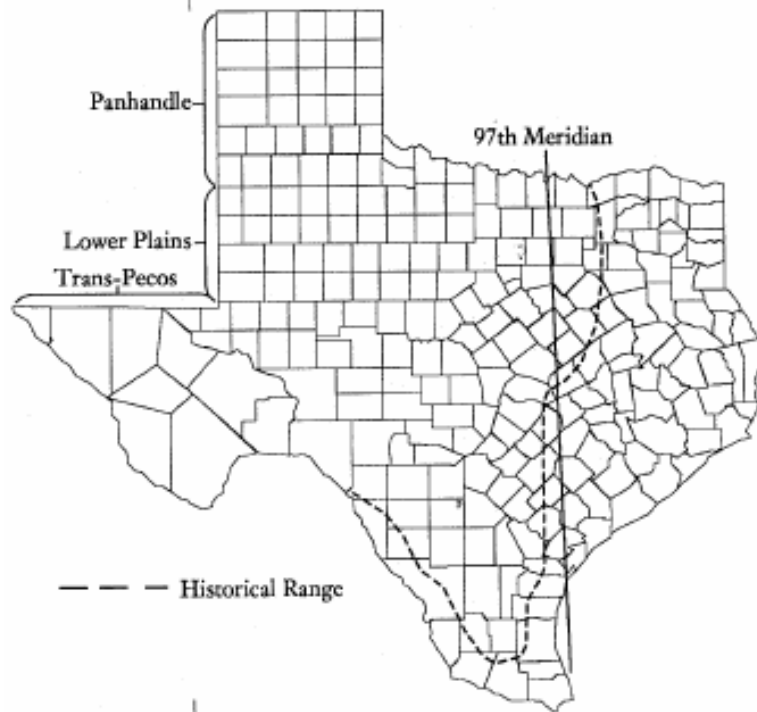

--- Historical Range

How are antelope counted?

Population estimates are obtained during aerial census conducted during June and July in areas containing the major populations. Ground counts may be conducted on small isolated herds when necessary. The information obtained includes total populations, buck:doe ratios, and percent fawn crop.

What determines how many antelope are harvested each year?

Once populations of both adults and fawns have been estimated, other factors such as sex ratios, vegetative conditions, weather conditions and management objectives are considered by the Texas Parks and Wildlife Department in issuing permits for the number of animals to be harvested during the annual hunting season. The harvest of surplus bucks through hunting is the primary management tool for the herd. The removal of mature bucks can produce trophies for the hunter, be a source of income for the landowner, and aid in maintaining a healthy herd.

The number of permits issued varies from about 900 to 2,500 annually and averages about 1,500. The harvest of pronghorns during the period of 1977-90 ranged from 458 in 1990 to 1,017 in 1987. Hunter success is high, averaging 92 percent. The harvest of pronghorns is very conservative, as reflected by the permit utilization rate that averages 48 percent.

Should antelope does be harvested?

Doe antelope can be harvested when conditions indicate possible harmful effect may result if the total herd is not reduced. When such a large surplus exists, the removal of doe antelope on particular areas prevents die-offs and tends to stabilize the population. The option of trapping surplus antelopes and removing them to another area is considered before doe permits are issued. In many cases trapping is the only means of obtaining a population reduction since obtaining an adequate doe harvest may be difficult because of limited interest from hunters.

Do antelope and livestock eat the same things?

The food habits of Texas pronghorns consist of 60-70 percent forbs (weeds and other broad-leafed flowering plants), 25-40 percent browse (leaves, twigs, young shoots of woody plants and vines) and less than 5 percent grass. They will also eat winter wheat or oats if fields are adjacent to rangeland habitat.

The degree of competition between antelope and cattle is not considered serious. However, the competition between antelope, sheep and goats can be severe and often results in the loss of antelope because of starvation. These losses can occur during times of poor range conditions such as a drought and when antelope are confined by netwire fences. The overlapping feeding habits of sheep, goats and antelope can eliminate the forbs and browse necessary for antelope survival.

Why are netwire fences a problem for pronghorns?

Pronghorn prefer to go through or under a fence. Since this is not possible with net wire fence or barbed wire fence with closely placed strands antelope can be enclosed in a death trap. Populations can be reduced to mere remnants or eliminated within a few years in wire encloses.

Will antelope transmit any kind of disease or parasites to my livestock?

Tests conducted by the Texas Parks and Wildlife Department in the Panhandle and Trans-Pecos have failed to find any evidence of brucellosis or leptospirosis in Texas pronghorns.

Internal parasites, including stomach worms, large intestinal worms and fringed tapeworms occur in antelope. External parasites that occur on Texas pronghorns include spinose ear ticks and winter ticks. Pronghorns infested with these internal and external parasites have shown no evidence of being affected by their presence. Since domestic livestock is regularly treated for both internal and external parasites, the parasites present in the antelope population should pose no problem to cattle or sheep.

W

hat are the factors that limit the growth of antelope populations?

Food— As previously stated, an antelope's diet consists primarily of forbs and browse plants with grasses taken only in small quantities. Often rainfall is insufficient or not received at the right time to produce adequate forb or browse growth. Also other factors such as the kind and number of livestock on the same range can affect the availability of antelope food items.

Water— Daily water consumption for pronghorns varies from 0.09 gallons/day to 1.19 gallons/day depending the total precipitation, evaporation, availability of succulent vegetation, and average maximum temperatures. Antelope will drink from livestock watering facilities and these need to remain usable on a year-round basis regardless of whether livestock is present or not. Generally ninety-five percent of the antelope herds are found within a 4-6 mile radius of a water source. The common occurrence of drought in Texas increases the importance of well distributed water sources.

Cover— Antelope typically inhabit low, rolling expansive terrain where their defense mechanisms of excellent eyesight and speed can be used as protection against predators. However, brushy cover is used as protection for newborn fawns, cover during prolonged periods of wind, snow and ice or as forage during prolonged droughts.

Predator— Coyote predation in Texas and adjacent states has long been considered a major factor in limiting pronghorn populations. Multiple observations over the years by Department field personnel indicate that the coyote is a formidable foe of antelope fawns and a pack of coyotes may occasionally bring down adult antelope.

Fencing/Barriers— Certain types of fences can be serious barriers to the movements of pronghorns. Providing free movement of antelope herds through fences during all seasons allows them access to various vegetative habitat types and reduces losses due to poor nutrition. Natural barriers such as large lakes or rivers, abrupt escarpments or mountain ridges, thick, high brush or trees, and deep canyons can also limit the expansion of populations.

Poaching— Poaching losses in most of the Texas antelope range is not considered high enough to have a significant effect on the population. Most poaching cases involve random shooting from county roads.



How can landowners determine how many antelope their land will support?

It is difficult to determine the number of antelope that a given area will support. The major natural determining factor of carrying capacity observed in the Trans-Pecos Region is the amount of rainfall received during August-October period. Studies have shown that the amount of rainfall received during this period will determine the availability of forage needed for pronghorns to recover their body condition after the rigors of the breeding season and for winter survival. A high percentage of bucks is lost in years with poor rainfall during this period than any other segment of the population. Also, during periods of light or below normal rainfall, does that are stressed by malnutrition may reabsorb embryos which will reduce the size of the fawn crop.



*Texas
Pronghorns 10*

What should a landowner consider before starting a predator control program?

When considering pronghorn-predator management, landowners should recognize that: (1) the quality and quantity of suitable pronghorn habitat are the overriding influence on all limiting factors. Improving the native habitat should be the primary focus in any management plan; (2) predator control is not a quick cure to be applied widespread when antelope populations are lower than desired; (3) predator control is seldom widespread or intense enough to "control" predators. Often insufficient control can stimulate predators' reproduction and result in a temporary population increase or cause an influx of predators from the surrounding "non-controlled" areas.

If it is determined that a predator control management plan is feasible, the following guidelines are recommended:

1. Consider other causes of mortality that are influencing antelope numbers.
2. Determine the pronghorn herd parameters that are desirable in terms of total numbers, rate of recruitment into the herd, age class of bucks desired, etc.
3. Determine the distribution of antelope populations on a year-round basis and the vegetative types involved.
4. Consider the cost of controlling coyotes balanced against the return expected.

*Texas
Pronghorns 11*

What can landowners do to increase antelope numbers?

Habitat

Improvement—Increase the amount of forage available for pronghorns by managing your livestock. Rotate livestock out of pastures when approximately 50 percent of the grass and forbs have been removed, use a light to moderate stocking rate and remember that sheep or goats will directly compete with antelope for available forages. Consult with local TPWD wildlife biologists or Soil Conservation Service personnel) to obtain advice on the use of other means of habitat manipulation such as prescribed burning, brush clearing, seeding of native forages or establishing food plots, and distribution of water sources.

Fencing—Several methods are used to insure the free movement of antelope where netwire fencing exist and still make it cattle-proof. Fold the bottom wire of net fence up in 100 yard lengths every 0.5 mile, leaving a space of 16 to 18 inches between the fence and ground. Replace netwire water gaps with barbed wire. Replace 100 yard sections of net wire fences every 0.5 mile with barbed wire fencing with the required space between the fence and the ground.

Supplemental **Feeding**

Antelope are very susceptible to large die-offs due to malnutrition, and may benefit greatly from feeding. Antelope will use alfalfa hay, sown winter wheat, rye or oat pastures in the winter months to provide nutrition needed that may not be available from native range. Landowners can establish food plots of these forages but should fence out livestock so that the plot will be available for antelope only. Supplemental feeds such as protein range blocks and 1/2 inch cube pellets are excellent food for antelope, if they learn to accept it as part of their diet. Feeding programs should begin in December or January and continue for several months in years when rainfall is limited in the spring and early summer. The cost of such feeding programs may be offset by higher survival rates, resulting in an increased population for larger harvests and economic gain through hunting for the landowner.

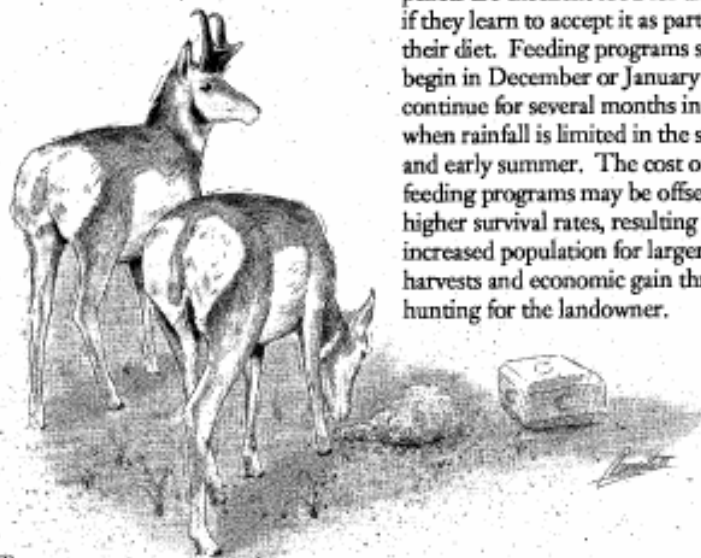

Does the Department trap antelope for restocking?

Trapping and transplanting of surplus antelope to vacant, suitable habitat has been used since 1939 to restore pronghorns to portions of their historic range. Candidate sites for restocking are obtained from landowner applications. Field inspections are conducted by TPWD wildlife biologists to determine habitat suitability. Suitable sites are approved and signed to wildlife management licenses to close the stocked areas to hunting for a specified time.

A total of 6,970 antelope has been trapped and moved to new ranges through 1990. Trapping and transplanting continue as the need arises, however the declining population in recent years has reduced the number of surplus pronghorns available for restocking.

Can antelope damage farm crops?

Some damage has been reported by farmers in the Panhandle when concentrations of pronghorns graze on winter wheat fields for extended periods of time. The type of damage reported includes wheat plants being pulled-up, trampling of plants or overgrazing in one part of the field resulting in poor grain production. Some landowners feel the pronghorns compete with cattle that also graze the same fields.

How is the age of an antelope determined?

Why is it important?

Age is determined by examination of the tooth eruption and replacement in the lower jaw. It has been found that predictable replacement of the front "milk" teeth with permanent teeth can indicate age.

Knowing the ages of antelope harvested during the hunting season is important in determining if the herd is being properly managed. If the harvest consists primarily of young bucks in the 1 $\frac{1}{2}$ to 3 $\frac{1}{2}$ age class, it usually indicates an overharvest of the buck populations with few trophy heads available to hunters. A high percentage of bucks 4 $\frac{1}{2}$ years or older indicates that there is ample bucks available to the hunter with the possibility of increasing the annual harvest.

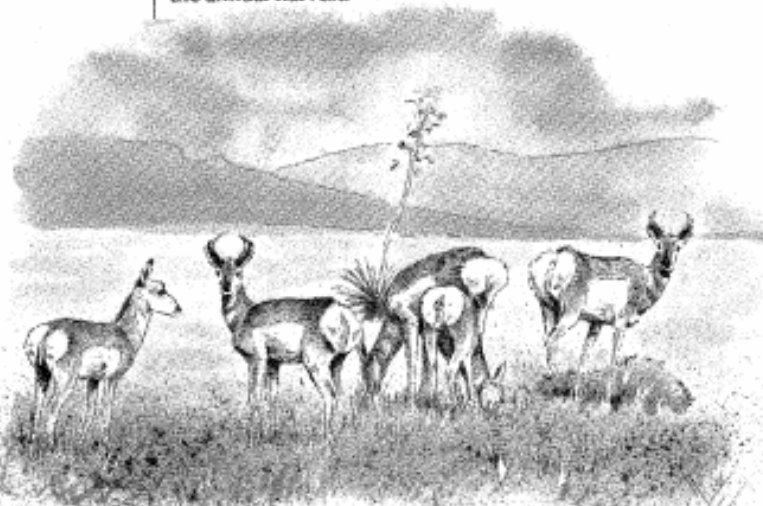

The following table and figures show the tooth eruption and replacement schedule for the front teeth in the lower jaw of the pronghorn antelope. Pronghorns can be aged up to 4 1/3 years by using the front teeth.

Table 1.

Age	Incisors		
	1	2	3
1 yr. 4 mos.	P	D	D
2 yrs. 4 mos.	P	P*	D
3 yrs. 4 mos.	P	P	P*
4 yrs. 4 mos. and over	P	P	P

D= Deciduous (milk) tooth
P = Permanent tooth
* = Variance within age class

Figure 2

Lower front teeth of 4-month old antelope – all teeth are deciduous.



Figure 3

Lower front teeth of 1 year 4 month old antelope – first incisors (middle teeth) are permanent, others are deciduous.



Figure 4

Lower front teeth of 2 year 4 month old antelope – first and second incisors are permanent, remainder deciduous.



Figure 5

Lower front teeth of 3 year 4 month old antelope – all three incisors are permanent, canines are deciduous.



Figure 6

Lower front teeth of 4 year 4 month old antelope – all teeth are permanent.



Appendix FF

Pesticides and Brush Control Texas Department of Agriculture

Pesticide Registration and Safety

The U.S. Environmental Protection Agency (EPA) and the Texas Department of Agriculture (TDA) register all pesticides used for brush control in the state of Texas. The Federal Insecticide, Fungicide and Rodenticide Act (FIFRA), the Food Quality Protection Act (FQPA), and Federal Food, Drug and Cosmetic Act (FFDCA) all regulate the use of pesticides in Texas to some degree. However, FIFRA and Texas pesticide laws and regulations are primarily involved in the registration process of brush control herbicides.



To be eligible for registration and use in Texas, pesticide products must first undergo a rigorous testing protocol required by EPA and then be registered federally. The testing protocol is extensive and must address issues such as efficacy and toxicity to non-target species. The vast majority of pesticide products that are registered in Texas are subject to over 140 scientific or toxicological tests in order to receive and maintain EPA product label approval, and subsequent Texas registration. Automatic approval does not occur for use of a pesticide in Texas if it is approved by EPA. Pesticides must meet state use and registration regulations in addition to strict EPA standards. The exact number of tests that must be performed for a pesticide to be allowed in Texas varies with its end-use, but it is extensive whatever the case. EPA evaluates a plethora of scientific studies before registering a product and uses a series of safety factors to determine the appropriate use patterns considering worst-case exposure scenarios.

Native Texas wildlife, especially threatened and endangered species, are given further consideration when performing risk assessments for the special use of pesticides in many brush control projects. Various classes of species are specifically targeted for detailed assessment, namely the chemical effects on amphibians and reptiles, birds, fish and invertebrates. The environmental fate of most compounds used in brush control is also carefully reviewed in order to protect water supplies. Factors such as degradative processes, absorption and mobility, field dissipation, as well as local ground and surface water concerns are considered in risk assessments, especially during special use considerations such as a FIFRA Section 24(c) allowances as discussed below.

Toxicity Category	Herbicide / Substance	Oral LD50	Equivalent Human Dose
I Severe Danger	Botulinus	0.00001	1 teaspoon or less
	TCDD (a dioxin)	0.1	
	Parathion	13	
	Strychnine	30	
	Nicotin	50	
II Moderate	Caffeine	200	1 teaspoon to 1 ounce
	2,4-D	375	
III Slight (caution)	Formaldehyde	800	1 ounce to 1 pint
	Aspirin, Vitamin	1700	
	Bleach	2000	
	Table	3750	
	Diuron	3750	
	Glyphosat	4320	
IV Very Slight	Imazapy	>5000	More than 1 pint
	Diesel	7380	
	Kerosen		
	Sugar		

Table 1: The equivalent human dose is that physical amount of the compound that would contain the oral lethal dose 50 (LD₅₀) amount.

In reality and for all practical purposes of assessment, the amount of pesticide that a sensitive species must be exposed to and cause a harmful effect is very unlikely to be seen with any use of a pesticide product (Table 1). Even when these species may encounter these registered pesticides in a natural setting, most of these chemicals have relatively low toxicity or similar toxicity to that of many household or natural materials (Table 2).

Table 2: Overall toxicity rating based on the LD₅₀ and the dermal response rating are from 1 to 5, with 5 being the least severe

COMMON NAME	TRADE NAME	ORAL LD50 mg/Kg	TOXICITY RATING	DERMAL RESPONSE RATING
nicotine	for comparison	50-60	2	-
paraquat	Surefire	120	3	3
caffeine	for comparison	200	3	-
diquat	Diquat	230	3	4
2,4-D	various brands	600	4	4
tebuthiuron	Spike	644	4	4
MSMA	various brands	1,800	4	4
Aspirin	for comparison	1,240	4	-
hexazinone	Velpar	1,690	4	4
dicamba	Banvel	2,900	4	4
prometon	Pramitol	2,980	4	-
atrazine	various brands	3,080	4	5
pendimethalin	Pendulum	3,277	4	4
Table salt	for comparison	3,320	4	-
diuron	Direx, Karmex	3,400	4	4
bromacil / diuron	Krovar	4,260	4	5
glyphosate	Roundup	4,320	4	5
sulfometuron methyl	Oust	>5000	5	4
imazapyr	Arsenal	>5000	5	4
imazapic	Plateau	>5000	5	5
prodiamine	Endurance	>5,000	5	4
simazine	Princep	5,000	5	4
bromacil	Hyvar	5,200	5	4
chlorsulfuron	Telar	5,545	5	5
picloram	Tordon	8,200	5	4
oryzalin	Surflan	10,000	5	4
norflurazon	Predict	>10,000	5	4
fosamine	Krenite	24,000		4

FIFRA Section 24(c) Special Registration

A FIFRA Section 24(c) is designed to expand a currently registered product label in the state of Texas for a documented special local need (SLN). A SLN means an existing or imminent pest problem within Texas for which TDA, based upon satisfactory supporting information, has determined that an appropriate federally registered pesticide product is not sufficiently available.

Documentation of need for the 24(c) registration in the form of letters from producers, grower organizations, experiment station personnel, and/or extension service personnel, must be provided to EPA. Research and/or test data, or summaries supporting efficacy and safety must be submitted. In addition, data documenting expected residue levels (when appropriate, mainly when food or feed crops are involved) must also be supplied with the application packet to EPA. Prior to issuing a Section 24(c), EPA and TDA determine that use of the product for which registration is sought will not cause unreasonable adverse effects



on man or the environment when used in accordance with labeling directions or widespread and commonly recognized practices. Endangered and threatened species are especially considered when evaluating special uses of pesticides. The U.S. Fish and Wildlife Service, Texas Parks and Wildlife Department and TDA are in regular contact concerning the well being of all native Texas species.

The Texas Department of Agriculture obtained a FIFRA Section 24(c) Special Local Need registration to use *Arsenal*[®] (active ingredient imazapyr) to control saltcedar to conserve water and protect native habitats.

In fact, in several cases, saltcedar is being controlled with *Arsenal*[®] to enhance wildlife habitat. The Canadian Municipal Water District is planning to control salt cedar beginning in September 2004 along the Canadian River. This effort is being made to stop the spread of salt cedar, which is estimated to consume almost 70,000 acre feet of water each year in the river basin, and to enhance habitat for the Arkansas River Shiner. In addition, U.S. Fish & Wildlife Service and Panhandle Water Conservation District officials have proposed a joint project to finance the control of salt cedars along the Canadian River to enhance habitat for the Arkansas River shiner.

In another instance, the U.S. Fish & Wildlife Service and Fort Worth Zoo requested that TDA change the restriction on the use of *Arsenal*[®] in Salt Creek in Culberson County to enhance habitat for the endangered Pecos Gambusia. Additionally, the Colorado River Municipal Water District has worked with U.S. Fish & Wildlife and the Texas Parks and Wildlife Department to use *Arsenal*[®] along the Colorado River to preserve habitat for the endangered Concho water snake and the endangered Texas poppy-mallow. The Concho water snake is not affected by *Arsenal*[®] because this chemical generally only affects plant species. The Texas poppy-mallow is not affected by the saltcedar spraying because its habitat is not near saltcedar due to different soil preferences between the two plant species. Additionally, GIS mapping is done before helicopter spraying of *Arsenal*[®] to pinpoint Texas poppy-mallow habitat.

Saltcedar (*Tamarisk*) Control in Texas

Saltcedar (*Tamarix spp.*) was introduced into the southwestern United States in the early 1800s from Eurasia as an ornamental shrub that aided in erosion control. A mature saltcedar may consume up to 200 gallons of water per day and is a problem for most of the western United States. Saltcedar trees occur in almost all of the water bodies of west Texas including the Pecos, Brazos, Canadian, Colorado, Rio Grande and Red rivers, and their tributaries.

Saltcedar has the ability to change its physical environment giving it a competitive advantage over native trees and shrubs. This occurs through increased surface soil salinity, lowered soil water potential and increased fire frequency. This invasive increases surface soil salinity by absorbing salts from deeper soil layers and groundwater and transporting these salts to their leaves, subsequently releasing the salts back into the surrounding soils through accumulation of leaf litter. The high tolerance for salt that saltcedar possesses allows for a competitive advantage. Increased soil salinity inhibits germination and growth of most other plant species.

The Texas Department of Agriculture is leading the Texas Riparian Invasive Plant (TXRIP) Taskforce in its endeavors to combat the spread of invasive riparian plants, especially saltcedar. This Taskforce is composed of almost every major state and federal agency with a mandate on this issue. TXRIP joins the US

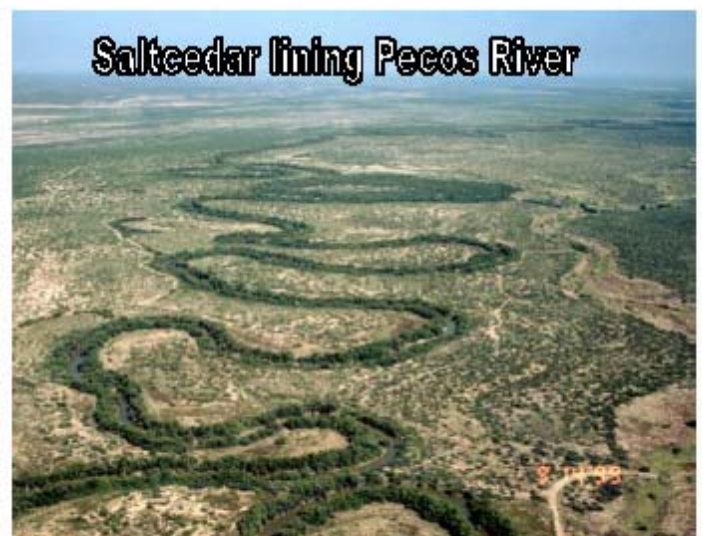

Tamarisk Coalition, the US Department of Interior, and the US Department of Agriculture in addressing this serious national problem. All scientifically tested methods for saltcedar control are assayed for use in control programs, including biological, chemical, and mechanical options.

Recent applications of federally approved herbicides, including *Arsenal*[®], has proven to be a very effective and safe tool to control saltcedar in selected segments of Texas waterways. This has spurred an interest in using this means of control in other infested water systems.



Supplemental Feeding of Deer in West Texas

Calvin Richardson
Technical Guidance Biologist



Trans-Pecos Wildlife Management Series
Leaflet No. 9

Prolonged periods of limited precipitation or “droughts” are the normal conditions in West Texas. Periods of generous rainfall and abundant forage growth occur but are the rare exception. Drought results in numerous impacts on deer and other wildlife. The two primary effects of drought on a deer herd include a reduction in fawning cover (affecting fawn survival) and a reduction in forage quantity and quality (impacting herd nutrition, reproduction, and survival). Many land managers in West Texas attempt to benefit deer on their ranch by providing supplemental feed.

Most deer managers providing supplemental feed are attempting to accomplish one of the following goals: 1) to improve nutrition and buck antler quality or 2) to increase deer numbers (or maintain deer numbers during drought). Some managers attempt to achieve both goals simultaneously which, as evidence has demonstrated, are goals that tend to conflict with one another (Verme and Ullrey 1984, Lewis 1990, Pekins and Tarr 1997, Brown 2001).

Types of Feeding Programs

The types of feeding programs for deer are almost as numerous as the ranches that provide feed. Some managers provide supplemental feed only during stress periods such as dry summers, dry winters (especially during the post-rut period), and during prolonged drought. Managers attempting to increase antler development may feed year-round or focus feeding efforts during the antler-growth months. Managers attempting to increase deer numbers may feed year-round or focus feeding efforts on reproduction (fawning season and just before conception).

Nutritional supplementation should not be confused with “baiting” (attracting deer to sites to increase harvest or temporarily concentrating deer for other purposes). Baiting is usually conducted with spin-cast feeders which periodically supply negligible amounts of corn or other feed. Nutritional supplementation, whether year-round or seasonal, normally involves free-choice feeders or feeding stations that allow the deer herd continuous access to feed with an emphasis on supplying nutrients that are lacking.

White-tailed deer readily take most kinds of supplemental forage. Mule deer are slightly more hesitant to accept artificial feeds, but mule deer in West Texas will take numerous forms of feed. Types of feed being used in West Texas include (but are not limited to) whole cottonseed, corn, peas, protein blocks, protein pellets, alfalfa pellets, alfalfa hay, peanut hay, cattle cubes, sheep and goat cubes, and waste candy products (peanut base). Supplemental-feeding programs may include mineral salt or blocks.

Potential Benefits of Supplemental Feed

Improved Nutrition

Numerous feeding programs have demonstrated that when conducted properly, supplemental feeding can improve the nutritional plane of the deer herd. Improved nutrition occurs when an adequate amount of the proper supplement (varies by season and location) is consumed by the deer herd in addition to a quality diet of native forage. Furthermore, nutritional improvement generally occurs *only* when deer numbers are controlled (i.e., the herd does not exceed the carrying capacity of the land). When deer numbers are allowed to increase in response to the supplemental feed, they can damage the habitat and eventually experience a declining nutritional plane (Lewis 1990, Schmitz 1990, Murden and Risenhoover 1996, Doenier et al. 1997, McCullough 1997). Habitat damage can also occur when a feeding program is used to maintain high deer numbers during drought.

Increased Antler Growth

Feeding programs can improve antler development if the bucks consume adequate amounts of the proper kind of feed at the right time and, most importantly, if the deer herd does not exceed the carrying capacity of the land. The percent of individual deer actually consuming feed can vary, and nutritional effects may be inconsistent by location (Verme and Ullrey 1984,

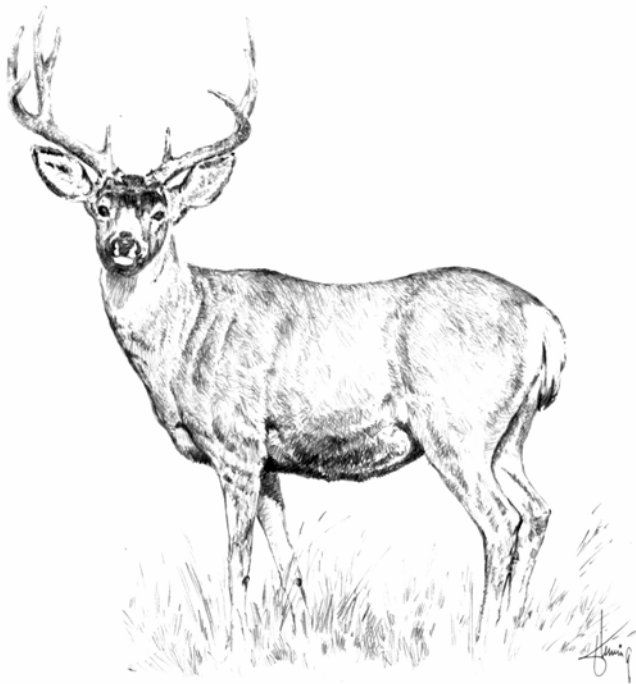

Schmitz 1990, Doenier et al. 1997, Bartoskewitz et al. 2003). Bartoskewitz et al. (2003) found that the proportion of bucks that used feeders on three South Texas ranches ranged from 23% to 48% in summer and 29-56% in winter. Of the bucks that actually consumed supplemental feed, body weights increased by 12-23%, but the effect on antler growth was inconsistent. The improvement in antler growth was 14% on one ranch and there was no significant effect on the other two ranches. Feeding programs are rarely successful in improving deer nutrition and antler growth if excessive deer numbers cause a decline in the quantity or overall composition of the native forage.

Increase in Deer Numbers

Supplemental feed can result in increased deer numbers if the proper kind of feed is provided at the right time and a substantial proportion of does are consuming the feed. Supplemented herds experience population increases partially because of increased yearling and adult survival but primarily because of increased fawn crops (improved nutrition increases doe conception rates and fawn survival). In low-fence situations deer may be attracted from surrounding properties, particularly during the initial years of a feeding program and during prolonged drought. However, an important consideration regarding feeding programs is whether or not increasing deer numbers is the best goal for the long-term health of the vegetation, the deer herd, and other wildlife species.

Improved Post-rut Buck Survival

Another goal associated with many supplemental feeding programs is to increase survival of bucks following the stress of the rut. During the breeding season, bucks may lose up to 20% of their body weight (Brown 1996). Many bucks have difficulty recovering, especially during dry winters and springs. Annual nonharvest mortality rates for white-tailed bucks have been reported in excess of 20% (Kie and White 1985, Nelson and Mech 1986, DeYoung 1989), with a substantial proportion of that occurring post-rut. In West Texas, Brunjes et al. (2005) reported average mortality rates of 20% for white-tailed bucks and 24% for mule deer bucks (included legal harvest), with most mortalities occurring during the rut and post-rut

months. It seems logical that supplemental feeds high in protein and energy would improve body condition of physically stressed bucks and increase survival until forage conditions improve. Certainly, the perception of many deer managers is that late winter/early spring feeding programs are effective in reducing buck mortality. The ability of supplemental feed to improve buck condition in winter may be hindered by a biological phenomenon—the tendency for deer (not just bucks) to reduce their forage intake during winter (French et al. 1955, Ozoga and Verme 1970, Holter et al. 1977). Reduced forage intake is associated with lower metabolic rates in winter that allow deer and other ruminants to survive under marginal forage conditions. In late winter their metabolism begins to increase in response to the lengthening period of daylight and results in increasing energy demands. Even when supplemental feed is available, buck condition may not improve substantially until hormone levels change and stimulate increased forage intake.

Potential Problems with Feeding Programs

Wildlife Movements and Distribution

The use of feeders and feeding stations has been documented as altering natural wildlife movements (Baker and Hobbs 1985, Williamson 2000, Brown 2001). Every wildlife species has specific habitat requirements and home ranges that shift seasonally in response to their needs. Although forage is only one of these habitat requirements, artificial feed can prevent deer herds and other wildlife from making natural movements which are dictated by habitat differences. Seasonal home range shifts and other natural movements by certain wildlife species have occurred for centuries because the movements directly benefit their health and survival. Altering natural movements with concentrations of feed may be causing problems that are not readily apparent. For example, feeding stations may prevent turkey flocks from moving to high quality winter roost sites, resulting in higher losses to predators. Similarly, feeders may prevent mule deer does from distributing naturally across the land and selecting the best fawning sites. Selecting inferior fawning areas near feeders may increase

predation losses. Murden and Risenhoover (1996) suggested that supplementation is disruptive to normal behavioral processes affecting the distribution of free-ranging deer on the landscape, and that these processes may be important in reducing the likelihood of deer overutilizing the more palatable, rare forage species. Under free-ranging conditions, animals normally disperse from habitats where forage resources have been depleted (Arnold and Dudzinski 1967). Supplementation tends to disrupt this natural process, allowing animals to remain in heavily utilized areas.

Disease Transmission

Supplemental feeding has been widely implicated as a causative factor that increases the occurrence of infectious and non-infectious wildlife diseases. Animals are attracted to artificial sources of feed in greater concentrations than normally occurs under natural conditions (Williams et al. 1993, Fischer et al. 1997). As animal density increases, competition for food also increases resulting in more frequent contact among individuals (Baker and Hobbs 1985, Schmitt et al. 1997). If one or more animals are harboring an infectious organism or prion, its transmission to uninfected individuals is facilitated by the increased frequency of contact among animals congregating at the feeding site (Miller et al. 1998). Frequent contact among individuals can also increase internal and external parasite loading. Although the parasites rarely kill the host animal, the physical condition of the deer (or other animal) may deteriorate to the point of increased susceptibility to predation or disease. It has also been suggested that stress from crowding weakens the immune system in some animals, increasing the likelihood of disease (Smith and Roffe 1994, Smith 2001). Depending on the nature of the disease and the feeding location, disease can be transmitted within or between species (Schmitt et al. 1997, Smith 2001), between wildlife and domestic animals (Thorne and Herriges 1992), or even between wildlife and humans (Rupprecht et al. 1995). Supplemental feeding has been suspected of contributing to the spread of tuberculosis and bluetongue in deer, chronic wasting disease in deer and elk, and brucellosis in elk and bison (Davis 1996, Williamson 2000). Moving feeders and feeding stations periodically may reduce the

risk of disease spread, but nothing can be done to prevent the unnatural concentration of animals that occurs in a feeding program.

Non-infectious illnesses can also occur when wild species are provided feeds that are incompatible with their digestive function (Wobeser and Runge 1975), feeds of poor nutritional quality (Ohio Wildlife Center 2000), or spoiled feeds that become toxic (Perkins 1991, Davis 1996, Breed 2002). For deer and other ruminants to effectively digest new forages and absorb nutrients, “microbial adaptation” in the rumen is essential which requires a gradual shift in the diet. Sudden and dramatic diet shifts seldom occur under natural conditions, but feeding programs that are initiated and/or discontinued abruptly can result in malnutrition and digestive illnesses despite an abundance of forage. This is why emergency winter feeding of deer in northern regions often fails to prevent death, despite high quality forage in the digestive tract (Nagy et al. 1967).

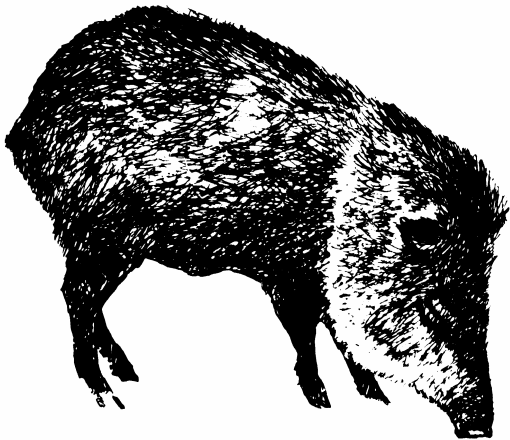

Non-target Species

The potential effects of providing artificial feed to wildlife usually extend well beyond the targeted species, especially if feed is provided over a prolonged period. Supplemental feed not only attracts deer but also non-target species (i.e., javelinas, feral hogs, aoudads, other exotics), including large predators as well as smaller predators (i.e., skunks, raccoons, foxes) that can impact ground-nesting birds. Mountain lions, bobcats, and coyotes quickly learn to take advantage of deer concentrations near feeders and feeding stations, which can negate the intended goals of some feeding programs. In

deer feeding programs that concentrate non-target species such as turkeys and quail, managers may be unintentionally increasing predation or the risk of disease for these and other bird species. Cooper and Ginnett (2000) found that feeders attracted nest predators and decreased survivorship of simulated ground nests within 400 yards of feeders. Furthermore, if plant materials are provided for artificial feed, there is increased likelihood of invasion by exotic plant species (Kosowan and Yungwirth 1999, Spurrier and Drees 2000).

The Wrong Supplement

Many supplemental feeding programs are conducted without a basic knowledge of the seasonal nutrient requirements of deer. If the supplement provided does not focus on the nutrients that are limiting on a ranch during a specific season, the program may be largely ineffective. Ironically, habituation by deer (or other species) to the “wrong” kind of supplemental feed can lead to nutritional deficiencies. For any animal, nutritional requirements vary by age, sex, and season. Deer and other wildlife species are constantly shifting their consumption of native forages to match their changing nutrient needs with corresponding changes in availability of forage types in the habitat. When large amounts of supplemental feed are consumed, a deer’s nutritional intake will be limited, to some degree, by the nutrients in the feed, which is usually less diverse and less complete than the combination of nutrients that can be obtained through native vegetation. For example, cottonseed is high in crude protein and energy (fats), but it contains few of the essential macro- and micro-minerals required by deer for physiological growth and development (including antler growth). If a comprehensive mineral mix is not provided in addition to cottonseed, the resulting deer diet may be mineral-deficient.

Impacts on Native Forage

One of the most serious and least recognized problems associated with supplemental feeding is the overuse of forage plants, particularly preferred woody plants and perennial forbs. The most common result of feeding programs is a substantial increase in deer numbers to the point of overpopulation. White-tailed and mule deer

are both very capable of reproducing beyond the carrying capacity of the habitat. Under natural conditions in West Texas, predators and periodic drought normally prevent deer herds from increasing beyond the land's carrying capacity. Intensive feeding programs usually result in increased reproduction and recruitment that exceeds mortality, ultimately producing herd growth that can exceed the carrying capacity within a few years. Additionally, feeding programs can attract deer from surrounding properties, at least during the initial years of the program and especially during prolonged drought. Excessive deer numbers resulting from one or both sources will result in overbrowsing of forage plants, especially the high quality forage plants (Murden and Risenhoover 1996). Because of severe and persistent droughts in West Texas, mortality of shrubs or portions of shrubs is a natural occurrence. However, mortality increases substantially for preferred shrubs and perennial forbs that are heavily browsed by excessive deer numbers. More importantly, preferred plants are not replaced through reproduction because seedlings are highly palatable and unable to survive browsing by excess animal numbers.

Even when deer numbers are kept within the carrying capacity of the land, overbrowsing tends to occur near feeding locations because of deer concentrations (Doenier et al. 1997, Williamson 2000, Ginnett et al. 2001). Doenier et al. (1997) found that winter supplementation in Minnesota increased browsing pressure within 900 yards of feeders, which resulted in loss of desirable forage species and increases in less desirable plant species. Ginnett et al. (2001) found browsing pressure to be 7 times as heavy near feeders compared to non-fed areas.

One of the greatest myths about supplemental feeding is that deer will consume supplemental feed instead of native vegetation. Numerous studies have documented heavy utilization of native forage despite the unlimited availability of high quality feed rations (Verme and Ullrey 1984, Schmitz 1990, Murden and Risenhoover 1996, Doenier et al. 1997, Bartoskewitz et al. 2003). Murden and Risenhoover (1996) documented an 8% increase in dry-matter intake by supplemented deer compared to a non-

supplemented herd. Furthermore, when provided a high-quality supplement, deer increased their use of rare, preferred forages and consumed proportionately less of the common forage species. This type of foraging pattern would have an obvious detrimental effect on the plant species composition if it occurred over an extended period.

Economics of Feeding

The high cost associated with supplemental feeding programs is another potential disadvantage. Regardless of the benefits (more deer, larger antlers, etc.), it is difficult if not impossible to recover the costs associated with an intensive feeding program (feed, feeders, storage, distribution) through increased lease fees or additional paying hunters. Numerous feeding operations have been examined in various regions of the state and none have proven feasible when based strictly on economics. It is certainly true that many landowners consider this fact about feeding programs an important barrier to their implementation. However, some "financially flexible" landowners are not concerned about whether the practice is economical, provided it helps them to accomplish certain deer management goals. Therefore, the problem of economic feasibility is not reason enough to prevent some managers from implementing a feeding program.

Why is Carrying Capacity Important?

No concept is more important for ranchers and deer managers to understand than *carrying capacity*. Carrying capacity applies to animals, plants, and people. One of the more common definitions for carrying capacity as it applies to animals, is "the number of animals that a habitat can support without causing habitat deterioration." The carrying capacity for a deer herd does not remain at a constant level in any region of Texas, but it is especially a moving target in the Trans Pecos where habitat conditions fluctuate dramatically. In fact, oscillations in animal numbers are not only natural but necessary in West Texas to prevent herds from exceeding the carrying capacity and causing long-term damage to the habitat.

The most important phrase associated with the definition of carrying capacity is **“without causing habitat deterioration.”** Of the four habitat components (food, water, cover, space), large grazers and browsers have the ability to impact the forage resource more than any other. Plants can be grazed and browsed to a certain extent without impacting the photosynthetic process (green leaves harnessing sunlight) that replenishes the root system and maintains plant health. When grazing/browsing animals exceed the carrying capacity, plant parts are consumed faster than they can be replaced. Overuse reduces photosynthesis and the health of the root system and overall plant. Continued overuse often results in plant mortality. Unhealthy plants are especially susceptible to mortality during extended drought, a frequent occurrence in the Trans Pecos. More importantly, excessive grazing/browsing severely reduces seed production and seedling establishment. Seedlings tend to be highly palatable and are unable to survive repetitive bites.

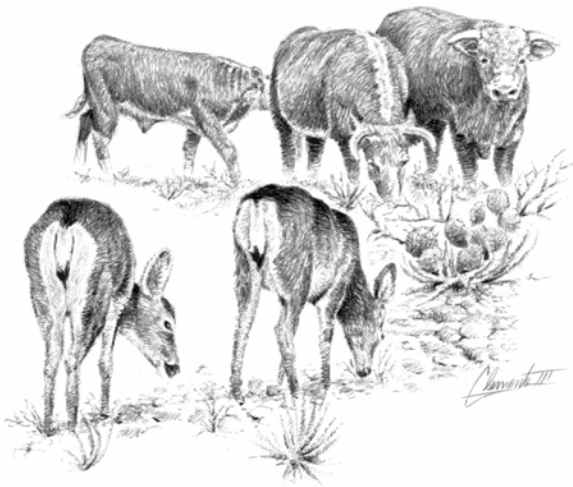

When grazers/browsers exceed the carrying capacity, forage overuse results in two general processes of habitat deterioration—a shift in the plant species composition and soil exposure and loss. The first process (shifting plant composition) occurs because highly preferred plants are consumed more heavily than less desirable plants. Excessive browsing results in mortality of desirable mature plants and prevents reproduction (reduced seed production and increased mortality of seedlings). The most preferred plants gradually represent a declining component of the plant community. Less

preferred woody plants (creosote, tarbush, mesquite, catclaw, javelinabush), forbs (broomweed), and grasses (threeawn, burrograss, fluffgrass) receive less grazing and browsing pressure, and are able to survive and reproduce unhindered. They gradually increase their representation in the plant community, effectively reducing the carrying capacity for livestock, deer, and other wildlife.

The second process resulting from excessive grazing/browsing is soil exposure and erosion. When perennial grasses and forbs are continually overused, the root systems deteriorate in health, and plant mortality occurs (especially during prolonged drought). When grasses and forbs die, topsoil is exposed to the elements. Highly valuable soil is lost to wind erosion and sheet/rill erosion during rainfall events. Soil exposure also results in crusting or “capping” of the soil surface, which interferes with seed germination and infiltration of rainfall. Additionally, soil temperatures on bare ground can become so high that it can prevent seed germination. As bare soil increases, there is less vegetation to intercept precipitation and funnel it down into the soil profile. Instead, most of the precipitation runs across the surface (sheet erosion) until it reaches a gully (rill erosion), then a draw and so on. Within hours (sometimes minutes), the vast majority of the precipitation has left the overgrazed rangeland in the form of runoff. Ultimately, there is less moisture available for plant growth and seed germination. More importantly, denuded rangelands result in less infiltration into the soil profile and reduced percolation into the underground waterways and aquifers. This is a primary cause for the reduced and/or halted flow of many springs and creeks in West Texas.

Considerations for a Feeding Program

For managers deciding whether or not a feeding program is appropriate for their ranch, consideration of the following factors is critical to the decision-making process:

- Develop very specific goals for the deer herd. The goals must be realistic and should be measurable (able to identify progress toward goals).

- Practical deer management goals cannot be developed without detailed information about the deer herd (population and nutritional indices) and thorough knowledge about the local limitations of the land.
- Annual deer surveys are important to understand trends in deer numbers and herd composition. Just as important is understanding the biases associated with each survey technique (Richardson 2002).
- Knowledge of annual fawn crops is essential, as well as understanding the true local influences on fawn survival (nutrition, fawning cover, predators, etc.).
- Understanding the current nutritional plane of the deer herd, the nutritional trend, and factors influencing nutrition among years. This can be determined by annual collection of harvest records by age class to include body condition, field-dressed weights, antler measurements, and lactation rates (if does are harvested).
- Knowledge of diversity and condition of deer forage plants, as well as reasons for low abundance, declining condition, etc. This is one of the most important and yet most often ignored steps in the process of assessing whether or not a feeding program is appropriate for a given ranch.
- Livestock cannot be managed independently of the deer herd because they both consume many of the same plants, especially as forage conditions deteriorate (and can have other impacts such as reduced fawning cover). If there are too many animals on the ranch, reducing animal numbers will provide far greater long-term benefits to the soil, plants, and wildlife than maintaining high animal numbers and providing supplemental feed.
- If a feeding program increases deer numbers beyond the carrying capacity of the ranch, do you have the ability to reduce deer numbers? More importantly, are you *willing* to reduce deer numbers?

Using the above process to understand the local deer herd and the limitations operating on the herd will often indicate that deer numbers are in balance with the habitat, and that improvements

in habitat quality (fawning cover, water, forage abundance and diversity) will produce an increase in deer numbers and quality. For managers that choose to initiate a supplemental feeding program, implementation of one or both of the following strategies will help to avoid the trap that most managers fall into with their feeding operations (little or no improvement in quality because of excessive deer numbers):

1) Contact a local TPWD biologist to help monitor deer numbers and forage conditions. When preferred plants begin to receive forage use in excess of 50% of the current year's growth, the herd is nearing carrying capacity of the habitat. When the deer herd is increasing and consistently producing high fawn crops (60-90%), a substantial doe harvest will be necessary to prevent overpopulation and habitat deterioration. A supplemented deer herd with high fawn survival will require an annual harvest of 20-25% of the doe segment to prevent further increases in deer numbers. For managers that wait too long (deer have already exceeded the carrying capacity), a harvest in excess of 30% of the doe segment will be required to reduce deer numbers.

2) If improving antler quality is the goal, restrict feeding efforts to the antler growing months to avoid producing excessive deer numbers. Antler growth (size) is influenced most by nutritional intake just prior to antler drop and during the first 2/3's of the antler development process. The last 1/3 of antler growth is primarily a period of mineral deposition (Muir et al. 1987). Feeding during late summer (fawning) and late fall/early winter (conception) will substantially increase conception rates and fawn survival, ultimately resulting in a population increase. A situation of increasing deer numbers generally conflicts with the goal of improving antler quality. The most common barrier in feeding programs to improving deer nutrition is excessive deer numbers.

An Ecologically and Economically Sound Management Strategy

The best long-term strategy for maintaining a healthy deer population with good body

condition, adequate fawn survival, and quality antler development while avoiding habitat deterioration involves the following practices:

- Maintain animal numbers (wildlife and livestock) at or below the carrying capacity of the land (can fluctuate dramatically among years). This requires knowledge of preferred forage species, and annual monitoring of forage use and deer herd nutritional indices (weights, antlers, etc.).
- Maintain abundant fawning cover through appropriate animal numbers and proper grazing management.
- For mule deer, periodic brush management may improve habitat quality (e.g., to control encroachment of mesquite, juniper, tarbush, creosotebush, etc.). No method of brush management is more natural and beneficial to plants and animals than periodic fire.
- Maintain well-distributed and wildlife-friendly water sources. Overflows and seeps that produce green vegetation are particularly valuable during drought.
- Maximize the benefits of precipitation by preventing runoff. By far, the best means of preventing runoff is to maintain good ground cover. Perennial, warm-season grasses (blue grama, bluestems, sideoats grama, tobosagrass, etc.) are more efficient than any other vegetation category in capturing rainfall and allowing infiltration into the soil horizon.

The Trans-Pecos region is unique, with frequent drought and dramatic fluctuations in forage conditions and carrying capacity for grazers and browsers. The limitations associated with West Texas require a patient and flexible manager. Managers who lack these traits are often more successful in areas with greater, more consistent rainfall. In West Texas, the best strategy for the long-term, well being of the deer herd, the habitat, and other wildlife species is to allow the number of grazers/browsers to fluctuate with changing weather and forage conditions. Managers may argue that hunting lease income will be reduced if deer numbers are allowed to decline. However, a thorough cost/benefit analysis of a feeding program will generally

discount that argument, and certainly, long-term damage to the habitat (by maintaining excessive animal numbers during drought) will reduce potential income from deer and livestock in the future.

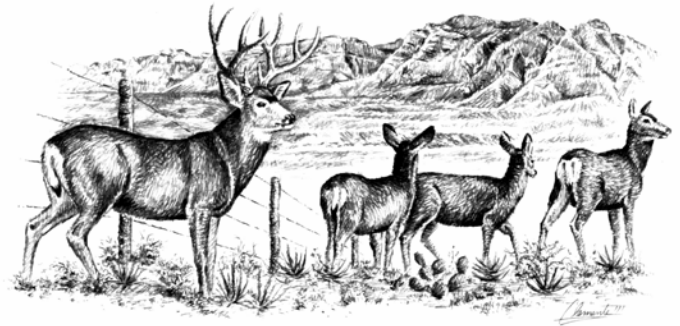

Acknowledgements: *I appreciate the helpful suggestions and comments provided on this management leaflet by the following Texas Parks & Wildlife Department personnel: Tim Bone, Ruben Cantu, Philip Dickerson, Mike Hobson, Mike Sullins, Misty Sumner, and Billy Tarrant.*

Literature Cited

- Arnold, G. W., and M. L. Dudzinski. 1967. Studies on the diet of the grazing animal, III. The effects of pasture species and pasture structure on the herbage intake of sheep. *Asst. J. Agric. Res.* 18: 657-666.
- Baker, D. L., and N. T. Hobbs. 1985. Emergency feeding of mule deer during winter: tests of a supplemental ration. *J. Wildl. Manage.* 49:934-942.
- Bartoskewitz, M. L., D. G. Hewitt, J. S. Pitts, and F. C. Bryant. 2003. Supplemental feed use by free-ranging white-tailed deer in southern Texas. *Wildl. Soc. Bull.* 31:1218-1228.
- Breed, A. 2002. Mycotoxins in wildlife. *Newsletter of the World Assoc. of Wildl. Veterinarians.* 12: 3-5.
- Brown, R. D. 1996. Nutrition requirements of white-tailed deer. Pages 1-6 in C. W. Ramsey, ed., *Supplemental feeding for deer: Beyond dogma.* Texas A&M Univ., College Station. 153 pp.
- Brown, R. D. 2001. The dangers of using supplemental feeding to increase carrying capacity of land for white-tailed deer. *Southeast Deer Study Group (oral presentation).* Feb. 19, 2001. 9 pp.

- Brunjes, K. J., W. B. Ballard, M. H. Humphrey, F. Harwell, and P. R. Krausman. 2005. Home range size and survival of male sympatric mule and white-tailed deer in Texas. *Southwest Nat.* (In Press).
- Cooper, S. M., and T. F. Ginnett. 2000. Potential effects of supplemental feeding of deer on nest predation. *Wildl. Soc. Bull.* 28:660-666.
- Davis, D. S. 1996. Aflatoxins and disease concerns. Pages 143-145 in C. W. Ramsey, ed., *Supplemental feeding for deer: Beyond dogma*. Texas A&M Univ., College Station. 153pp.
- DeYoung, C. A. 1989. Mortality of adult male white-tailed deer in south Texas. *J. Wildl. Manage.* 53: 513-518.
- Doenier, P. B., G. D. DelGiudice, and M. R. Riggs. 1997. Effects of winter supplemental feeding on browse consumption by white-tailed deer. *Wildl. Soc. Bull.* 25:235-243.
- Fischer, J. R., D. E. Stallknecht, M. P. Luttrell, A. A. Dhondt, and K. A. Converse. 1997. Mycoplasmal conjunctivitis in wild song-birds: The spread of a new contagious disease in a mobile host population. *Emerging Infectious Diseases* 29: 118-122.
- French, C. E., L. C. McEwen, N. D. Magruder, R. H. Ingram, and R. W. Swift. 1955. Nutritional requirements of white-tailed deer for growth and antler development. *Bull.* 600. University Park: Pennsylvania Agric. Exp. Stn. 50 pp.
- Ginnett, T. F., M. K. Owens, S. M. Cooper, and R. M. Cooper. 2001. Effects of deer feeders on home range size, use of space, and vegetation utilization of white-tailed deer. Pages 46-47 in *Texas Chapter The Wildlife Society Annual Meeting Abstracts*. College Station, Texas.
- Holter, J. B., W. E. Urban, Jr., and H. H. Hayes. 1977. Nutrition of northern white-tailed deer throughout the year. *J. Anim. Sci.* 45: 365-376.
- Kie, J. G., and M. White. 1985. Population dynamics of white-tailed deer (*Odocoileus virginianus*) on the Welder Wildlife Refuge, Texas. *Southwest Nat.* 30: 105-118.
- Kosowan, A., and F. Yungwirth. 1999. Canada thistle survey summary. East Boreal Ecoregion, Saskatchewan Environment.
- Lewis, T. L. 1990. The effects of supplemental feeding on white-tailed deer in northwestern Wisconsin. PhD. Thesis, Univ. of Wisconsin, Madison, Wisconsin.
- McCullough, D. R. 1997. Irruptive behavior in ungulates. Pages 69-98 in W. J. McShea, H. B. Underwood, and J. H. Rappole, eds., *The science of overabundance: Deer ecology and population management*. Smithsonian Inst. Press, Washington, D. C. 402 pp.
- Miller, M. W., M. A. Wild, and E. S. Williams. 1998. Epidemiology of chronic wasting disease in captive Rocky Mountain elk. *J. Wildl. Dis.* 34: 532-538.
- Muir, P. D., A. R. Sykes, and G. K. Barrell. 1987. Calcium metabolism in red deer offered herbages during antlerogenesis: Kinetic and stable balance studies. *J. Agric. Sci.* 109: 357-364.
- Murden, S. B., and K. L. Risenhoover. 1996. Forage used by white-tailed deer: Influence of supplemental feeding. Pages 131-141 in C. W. Ramsey, ed., *Supplemental feeding for deer: Beyond dogma*. Texas A&M Univ., College Station. 153 pp.
- Nagy, J. G., G. Vidacs, and G. M. Ward. 1967. Previous diet of deer, cattle, and sheep and ability to digest alfalfa hay. *J. Wildl. Manage.* 31: 443-447.
- Nelson, M. E., and L. D. Mech. 1986. Relationship between snow depth and gray wolf predation on white-tailed deer. *J. Wildl. Manage.* 50: 471-474.
- Ohio Wildlife Center. 2000. Dealing with nuisance waterfowl. (see www.ohiowildlifecenter.org)
- Ozoga, J. J., and L. J. Verme. 1970. Winter feeding patterns of penned white-tailed deer. *J. Wildl. Manage.* 34: 431-439.
- Pekins, P. J., and M. D. Tarr. 1997. The impact of winter feeding on the population dynamics of white-tailed deer in northern New Hampshire. Final Report, Fed. Aid in Wildl. Restor. Study W-12-R, Proj. 3, Job 2. New Hampshire Fish and Game Dept., Concord. 58pp.
- Perkins, J. R. 1991. Supplemental feeding. Texas Parks and Wildlife Dept., Wildlife Division, PWD BK W7100-033. Austin. 19 pp.
- Rupprecht, C., J. S. Smith, M. Fekadu, and J. E. Childs. 1995. The ascension of wildlife rabies: a cause for public health concern or intervention? *Emerging Infectious Diseases* 1: 107-114.
- Richardson, C. L. 2002. Comparison of deer survey techniques in west Texas. Pages 61-71 in L. A. Harveson, P. M. Harveson, and C. L. Richardson, eds. *Proceedings of the Trans-Pecos Wildlife Conference*. Sul Ross State Univ., Alpine, Texas.
- Schmitt, S. M., S. D. Fitzgerald, T. M. Cooley, C. S. Bruning-Fann, L. Sullivan, D. Berry, T. Carlson, R. B. Minnis, J. B. Payeur and J. Silarskie. 1997. Bovine tuberculosis in free-ranging white-tailed deer from Michigan. *J. Wildl. Dis.* 33:749-758.
- Schmitz, O. J. 1990. Management implications of foraging theory: evaluating deer supplemental feeding. *J. Wildl. Manage.* 54: 522-532.
- Smith, B. L. 2001. Winter feeding of elk in western North America. *J. Wildl. Manage.* 65: 173-190.
- Smith, B. L., and T. Roffe. 1994. Diseases among elk of the Yellowstone Ecosystem, USA in W. van Hoven, H. Ebedes, and A. Conroys, eds., *Wildlife ranching: a celebration of diversity—Proc. of the 3rd Int. Wildl.*

Ranching Symp. Pretoria: Center for Wildl. Manage.
Univ. of Pretoria.

- Spurrer, C., and L. Drees. 2000. Hostile takeovers in America: invasive species in wildlands and waterways. Transactions of the 65th North American Wildlife and Natural Resources Conference 65: 315-325.
- Thorne, E. T., and J. D. Herriges, Jr. 1992. Brucellosis, wildlife and conflicts in the Greater Yellowstone area. Trans. No. Amer. Wildl. And Natur. Resour. Conf. 57: 463-465.
- Verme, L. J., and D. E. Ullrey. 1984. Physiology and nutrition. Pages 91-118 in L. K. Halls, ed. White-tailed deer ecology and management. Stackpole Books, Harrisburg, Pa.
- Williams, E. S., E. T. Thorne, S. L. Anderson, and J. D. Herriges. 1993. Brucellosis in free-ranging bison (*Bison bison*) from Teton County, Wyoming. J. Wildl. Diseases 29: 118-122.
- Williamson, S. J. 2000. Feeding wildlife—just say no. Wildl. Manage. Inst., Washington, D.C., 43 pp.
- Wobeser, G., and W. Runge. 1975. Rumen overload and rumenitis in white-tailed deer. J. Wildl. Manage. 39: 596-600.

Trans-Pecos Vegetation: A Historical Perspective

Calvin Richardson
Technical Guidance Biologist



Trans-Pecos Wildlife Management Series
Leaflet No. 7

The Trans-Pecos region is the only part of Texas where mountain and desert habitats are found. This unique combination contributes to the tremendous vegetation diversity in the region, which includes at least 268 grass species and 447 species of woody plants. The vegetation diversity is also influenced by the Edwards Plateau eco-region in portions of Terrell, Pecos, and Brewster counties. In addition, there are vegetational influences in the northeast Trans Pecos by the plains ecosystem and in the southeast Trans Pecos by the Tamaulipan Province (south Texas plains). Like other ecosystems, the Trans-Pecos region is dynamic and has experienced gradual shifts in climate and vegetation. For example, there is strong paleoecological evidence that much of the Trans-Pecos region was once covered (approx. 11,000 years ago) by a mesic woodland (Van Devender 1995). However, the vegetation and wildlife has changed more rapidly in composition, abundance, and distribution over the past 120 years than at any other time in recorded history. The major influences behind these dramatic changes were (and continue to be) livestock grazing and the suppression of fire combined with frequent drought.

Vegetation Changes

Considerable information about historical Trans-Pecos landscapes (prior to Anglo settlement) has been accumulated from survey records, journals, photographs, and various other records from early explorers of the region. All early accounts provide evidence that the Trans-Pecos grasslands were quite expansive and that grasslands were lightly interspersed with shrubs and desert succulents (Bartlett 1854, Parry 1857, Echols 1860, Bray 1901, Cottle 1931, Humphrey 1958, Wondzell 1984, Hall 1990). Waste-high grass was reported along Terlingua Creek and in Tornillo Flats (Echols 1860), where eroded desert exists today. Extensive grass cover was described in the Big Bend area about 1900 when high numbers of livestock were being grazed in the region (Langford and Gipson 1952). In 1885

Terlingua Creek was described as a running creek full of beaver and lined with cottonwood trees (Wauer 1973, Wuerthner 1989). Evidently, mesquite was not nearly as abundant or widespread as today, existing only as scattered shrubs among the grasslands and occurring in small isolated stands (Humphrey 1958, Johnston 1963). There is no mention of the dense stands of whitethorn acacia or catclaw mimosa that dominate some areas of the Trans Pecos today. One account in the early 1850's from the Pecos River near Horsehead Crossing noted that there were no trees or shrubs along the banks of the river (Humphrey 1958). Today, the Pecos River at Horsehead Crossing is choked with saltcedar, mesquite, and other woody plants.

By all accounts, it is evident that desert grasslands throughout the southwestern United States,

including the Trans-Pecos Region, have changed since Anglo settlement. Furthermore, it is well documented that grasslands have decreased and given way to increases in woody plant abundance and bare ground in some areas (Cottle 1931, Parker and Martin 1952, Buffington and Herbel 1965, Grover and Musick 1990). Prominent woody invaders and increasers of the low elevation desert grasslands include creosotebush, tarbush, mariola, whitethorn acacia, honey mesquite, and cacti. Prominent woody invaders and increasers of the higher elevation plains grasslands include juniper, catclaw mimosa, sacahuiste, cane cholla, adolpia, and prickly pear species. Numerous studies have been conducted to evaluate the causes responsible for the rapid changes in the vegetative communities. Most investigators attribute the increase in shrubs to overgrazing of grasslands by livestock, and considerable evidence has been cited in support of this concept (Humphrey 1958, York and Dick-Peddie 1969, Grover and Musick 1990, Gillis 1991). Several additional factors have been hypothesized as contributing significantly to vegetation changes in semi-desert grasslands. The factors most often considered, in addition to heavy grazing, are changes in climate, suppression of grassland fires, short and long drought periods, plant competition, and erosion of topsoil in areas where vegetation has been removed. All of these factors probably have been and are contributing to a reduction in desert grasslands and an increase in shrubs.

Healthy grassland savannas exist today on sites where wildfires have occurred or where prescribed burning is practiced, as well as on ranches that have been conservatively grazed and properly managed for decades. Most of these healthy grassland savannas occur at moderate to high elevations (cooler temperatures and greater average rainfall) in Hudspeth, Jeff Davis, Presidio, and Brewster counties.

Early Ranching Activity

Livestock grazing in the southwestern United States dates back to the 1500's (Humphrey 1958, Bahre 1991). In the mid-1500's cows, sheep, and horses were brought into the southwest from Mexico. Some of the animals were lost or strayed and gave rise to feral herds that grazed the region. The number of cattle, sheep, and horses

increased steadily after 1598, although for many years Indian hostility forced the herders to concentrate their grazing activity near the towns of El Paso, Santa Fe, Taos, and Tucson (Humphrey 1958). Spanish missionaries and farmers gradually increased the number of sheep and goats along the Rio Grande between El Paso and present day Presidio, herding sheep into the Trans-Pecos high country during the summer (Carlson 1982). The number of sheep and goats gradually declined after 1767, when the Spanish decided to retreat from most of Texas and New Mexico. In the Big Bend region, Milton Faver was reportedly the first Anglo rancher, who moved into southern Presidio County in 1857. He subsequently built a sizeable cattle herd (10,000-20,000 head), along with 5,000 sheep and 2,000 goats.

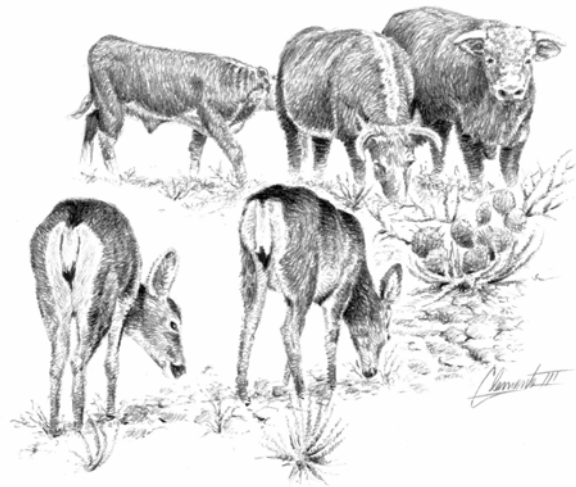

Extensive ranching in the Trans-Pecos began in the early 1880's when the first Anglo Americans settled in the Big Bend region. Livestock numbers peaked in the late 1880's soon after completion of the Texas and Pacific Railroad (in 1883) through the region. By 1885 relatively large herds of livestock were being raised in the Trans-Pecos. But it was not long before drought and severe winters (1885-1895) drastically reduced the herds. Many of the cattle companies that began their operations in the 1880's were out of business by 1905. Range conservation and management was born subsequent to the "apalling" losses of cattle from drought and starvation, the lowered rangeland productivity, and "the associated evils of soil erosion, water loss, and encroachment by noxious weeds" (Gould 1951).

Given the descriptions of the vegetation by early explorers, it is not difficult to understand what attracted these early ranchers to the Trans-Pecos region. For example, Juan Mendoza in 1864 (in present day Presidio County) describes "a beautiful plain, with plentiful pasturage of couch grass." Captain John Pope in 1854 described the Trans-Pecos area as ". . . destitute of wood and water, except at particular points, but covered with a luxuriant growth of the richest and most nutritious grasses known to this continent. . . The gramma-grass, which exists in the most profuse abundance over the entire surface of these tablelands is nutritious during the whole year, and . . . seem intended by nature for the maintenance of countless herds of cattle" (Weniger 1984). What the early ranchers could not have understood is the complexity of interacting factors that allowed this sensitive ecosystem to support the vast expanses of grasslands and grassland-savannas. The first settlers were probably unaware of the brutal droughts that frequently occur in this region. They probably did not comprehend the critical role of periodic natural fires in maintaining the health and integrity of the grassland systems. Finally, a concept they could not have understood is that an ecosystem maintained by frequent drought, periodic fire, and very low numbers of grazing animals is not capable of supporting high numbers of grazing animals on a continuous or long-term basis without rangeland degradation.

To provide some idea of the livestock densities that were grazed in the region, some specific examples are described below (present day stocking recommendations normally range from 75 to 200+ acres/animal unit³):

- In 1881 the Iron Mountain Ranch near Marathon was stocked with 27,000 head of sheep on 45,000 acres, a stocking rate of 8.3 acres/animal unit (Clayton 1993).
- In the mid-1880's, Lawrence Haley was running 15,000 sheep on 37,000 acres south of Alpine, a stocking rate of 12.3 acres/animal unit (Carlson 1982).

³ 5 sheep = 1 animal unit, 6 goats = 1 animal unit, 1 cow = 1 animal unit, 1 horse = 1.5 animal units

- In the mid-1890's, the Downie Ranch in Pecos County was stocked with 20,000 head of cattle, 80,000 sheep, 2,000 goats, 500 horses on 234 sections, a stocking rate of 4.1 acres/animal unit (Downie 1978).
- In the mid-1890's, the Western Union Beef Company stocked 400 sections near Fort Stockton with 30,000 head of cattle (8.5 acres/animal unit), but only 22,000 head (11.6 acres/animal unit) could be found in 1897 after the Indians, rustlers, and predators had their share (Downie 1978).

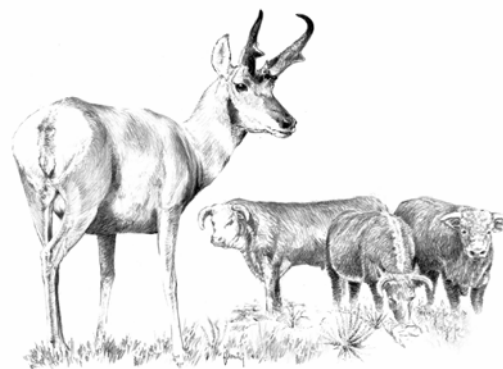

The high stock densities during the 1880's and 1890's certainly had an impact on vegetation and on rangeland productivity, including soil erosion - as was indicated by descriptions of drought and starving animals. However, high stocking rates in many areas of the Trans Pecos during the next 4 or 5 decades continued to deteriorate rangelands and permanently reduce rangeland productivity. Sheep and goat numbers in the Trans Pecos gradually increased during the early 20th century and peaked in the 1940's. The sheep and goat industries in West Texas remained strong through the 1950's and 1960's and then steadily declined.

Suppression of Grassland Fires

Historically, fire played a major role in shaping and maintaining the Trans-Pecos grasslands (Wright and Bailey 1982, McPherson 1995, Frost 1998, Van Auken 2000), just as fire has influenced and maintained other grasslands of North America. Although periodic fire is an integral component of healthy rangelands, it is not the only process that has shaped the grasslands and savannas of the desert Southwest. Frequent drought, insects, disease, rodents, rabbits, and other browsers/grazers serve a role in

maintaining grassland integrity by interacting with fire to control woody plants. In the absence of fire, grasslands gradually revert to dominance by woody plants. In arid environments, grass plants can often survive during drought and they thrive during periods of good rainfall with 2 very important provisos: 1) the density of shrubs and succulents (cholla, yucca, cacti, etc.) does not become excessive and 2) top-removal of grass plants does not occur too frequently.

Fire is a natural mechanism for controlling encroachment by woody plants and succulents, involving only periodic top-removal of herbaceous vegetation (7-12 year frequency in the higher elevations; 10-20 year frequency in the desert grasslands). If woody plants are allowed to increase, their deep, spreading root systems eventually out-compete grasses with the interacting effect of repeated droughts. If grass plants are continually defoliated (e.g., continuous heavy grazing), the photosynthetic structures (green leaves) are not allowed to replenish root with starches and carbohydrates. The result is declining root health, weakened plants, and eventual mortality, especially during drought. In addition, excessive grazing pressure prevents reproduction of herbaceous plants, especially problematic in areas of frequent and persistent drought.

The greatest impact of reduced herbaceous cover, whether through overgrazing, woody plant competition, or their combined effect, is exposure of bare soil. When the soil surface is not covered by grasses/forbs and exposed to the elements (wind and rainfall), erosion is inevitable. The immediate effect of increasing bare ground is substantial loss of water that otherwise would be conserved through soil infiltration, deep percolation, and absorption by grass roots. The loss of grass cover and increasing loss of water through runoff (reduced percolation into water table) is the primary reason that Trans-Pecos springs and creeks described in historical documents have dried up (the increasing number of water wells developed for irrigation, livestock, and human use also contributed to the problem). Another "immediate" effect is that exposed soil quickly becomes encrusted or "capped," which hinders water infiltration, moisture retention, and seed germination. The long-term effect of increasing bare ground is soil loss through erosion, which reduces the capability of the land

to support vegetation and permanently decreases the carrying capacity of the land for livestock and wildlife.

A less apparent effect of fire suppression and heavy grazing pressure in West Texas is a gradual shift in species composition of herbaceous plants. Deep-rooted perennial bunchgrasses (blue grama, sideoats grama, bluestems, Arizona cottontop, tanglehead, green sprangletop, tobosagrass) gradually give way to less desirable, shallow-rooted species (threeawn, burrograss, fluffgrass, red grama, slim tridens). Not only do the leafy bunchgrasses receive more pressure through repeated selection by grazers, but perennial bunchgrasses are fire tolerant (fire dependent, to some extent). The growing points of most bunchgrasses are protected beneath the soil, and periodic fire tends to stimulate seed germination of perennial, warm-season bunchgrasses. Timely grazing deferment and periodic fire can reverse this trend in the species composition of herbaceous plants. Although shallow-rooted species are better than bare soil, the value of maintaining deep-rooted bunchgrasses is 2-fold: 1) bunchgrasses support greater livestock numbers and greater wildlife numbers and diversity, and 2) bunchgrasses are superior in maintaining the soil hydrology (better water infiltration, retention, and deep percolation)

Today, the most common barrier to wildfire in desert grasslands is inadequate quantity and continuity of fine fuels. Livestock grazing over the past 120 years has reduced the herbaceous biomass enough to prevent the spread of fire in most years. Other constraints on the use of fire as a management tool include lack of knowledge about fire benefits, lack of experienced assistance, liability concerns, potential threat to ranch facilities and structures, and short-term financial considerations associated with grazing deferment before and after the fire. Opportunities currently exist for use of prescribed fire in desert grasslands to prevent further shrub invasion and, to some degree, reverse the trend. In many areas of the Trans-Pecos, however, a major reclamation program involving brush control and grazing deferment would be required to partially restore desert grasslands before fire could be implemented in a management program.

Current Habitat Management Practices



For long-term benefits to wildlife in West Texas, no habitat management practices are more important than those that restore and/or maintain healthy, native, herbaceous vegetation. Every wildlife species in the Trans-Pecos, whether a game or nongame species, depends upon grasses and forbs to satisfy at least one essential requirement-- whether it's nesting cover, fawning cover, nutritious "greens," seeds, insects, or a source of water. Just as important, grasses and forbs stabilize the soil and conserve precious moisture that comes infrequently. And certainly not least, herbaceous plants provide fuel for prescribed fire, the only "natural" tool and the lowest cost practice for long-term prevention of shrub encroachment.

The emphasis on the restoration and maintenance of herbaceous cover (grasses and forbs) does not diminish the importance of trees, shrubs, and desert succulents. Prior to settlement in the late 1800's, woody plants and succulents were sparsely scattered across the desert grasslands, with increased abundance along wet draws, rocky outcroppings and steep slopes. Their extensive root systems serve the important function of stabilizing soil on these potentially erosive sites (these areas seldom burn and are unable to support protective stands of grass). Woody plants also provide valuable food and cover for many wildlife species and livestock. Woody plants shift from a valuable habitat component to an ecosystem threat only when one or more of the "balancing" processes are removed (e.g., fire or herbaceous vegetation via overgrazing).

Maintenance of healthy grasslands and savannas in West Texas is best accomplished through periodic fire and timely light to moderate grazing, limited to years during and after favorable rainfall. Prescribed fires promote perennial forbs and perennial, warm-season bunchgrasses and

prevent detrimental increases in woody shrubs. Repeated prescribed fires during the proper season (late spring or early summer) can inflict mortality on woody species that have already encroached in desert grasslands (restoration will initially require greater fire frequency than that occurring historically for grassland maintenance). Light to moderate grazing during favorable years, using no more than 1/3 of grass production (Holechek et al. 1994), will allow use of excess forage production without weakening root systems and causing plant mortality during drought years. Flexibility with livestock numbers and grazing deferment are critical tools in managing vegetation in the Trans Pecos where weather fluctuations are more dramatic than in any other region of Texas.

Degraded rangelands where soils and water (precipitation) are being lost annually can often be improved through a number of soil and water conservation techniques. Erosion control techniques such as water diversions and sediment traps should be implemented. Header dams, rangeland ripping (Ueckert and Petersen 2002), and berms are water conservation techniques that can partially restore the hydrology on specific sites and initiate seed germination. Other habitat improvement practices that may apply to specific situations in the Trans Pecos include the following:

- Mechanical brush management
- Chemical brush management
- Riparian habitat management (fencing to control time/intensity of grazing; native shrub and tree planting; control invading shrub species)
- Grazing management (light to moderate grazing in favorable years; pasture deferment)
- Water distribution
- Improved water access for birds and small mammals
- Windmill/trough overflows to create oases of green forbs/grasses, seeds and insect production
- Irrigated food plots
- Fence modification to allow unimpeded movement of pronghorn antelope and bighorn sheep
- Reduction of deer in certain areas where numbers are high

- Reduction of exotic or feral animals that are impacting and/or competing with native species



Acknowledgements: The following individuals provided helpful comments and suggestions on this management leaflet in draft: Ruben Cantu (TPW), Philip Dickerson (TPW), Scott Lerich (TPW), Steve Nelle (NRCS), Mike Sullins (TPW), Misty Sumner (TPW), and Jason Wrinkle (TNC).

Literature Cited

- Bahre, C. J. 1991. A legacy of change. Univ. of Arizona Press, Tucson.
- Bartlett, J. R. 1854. Personal narrative of explorations and incidents in Texas, New Mexico, California, Sonora, and Chihuahua.
- Bray, W. L. 1901. The ecological relations of the vegetation of western Texas. *Bot. Gaz.* 32: 99-123.
- Buffington, L. C., and C. H. Herbel. 1965. Vegetation changes on a semidesert grassland range from 1858 to 1963. *Ecological Monographs* 35: 139-164.
- Carlson, P. H. 1982. Texas Woollybacks: The Range Sheep and Goat Industry. Texas A&M Univ. Press, College Station.
- Clayton, L. 1993. Historic Ranches of Texas. Univ. of Texas, Austin.
- Cottle, H. J. 1931. Studies in the vegetation of southwestern Texas. *Ecology* 12: 105-155.
- Downie, A. E. 1978. Terrell County, Texas, its past- its people. Rangel Printing, San Angelo, Tex.
- Echols, W. H. 1860. Camel expedition through the Big Bend country. U.S. 36th Congress, 2nd Session, Senate Ex. Doc., doc. 1, pt. 2, U.S. Serial Set No. 1079, pp. 36-50.
- Frost, C. C. 1998. Presettlement fire frequency regimes of the United States: a first approximation. Pages 70-81 in T. L. Pruden and L. A. Brennan, eds. Fire in ecosystem management: shifting the paradigm from suppression to prescription. Tall Timbers Fire Ecology Conference Proceedings, No. 20. Tall Timbers Research Station, Tallahassee, FL.
- Gillis, A. M. 1991. Should cows chew cheatgrass on commonlands? *Bioscience* 41:668-675.
- Gould, F. W. 1951. Grasses of the Southwestern United States. Univ. of Arizona Press, Tucson.
- Grover, H. D., and H. B. Musick. 1990. Shrubland encroachment in southern New Mexico, U.S.A.: An analysis of desertification processes in the American Southwest. *Climatic Change* 17: 305-330.
- Hall, S. A. 1990. Pollen evidence for historical vegetational change, Hueco Bolson, Texas. *Tex. J. Sci.* 43: 399-403.
- Holechek, J. L., A. Tembo, A. Daniel, M. J. Fusco, and M. Cardenas. 1994. Long-term grazing influences on Chihuahuan Desert rangeland. *The Southwestern Naturalist* 39: 342-349.
- Humphrey, R. R. 1958. The desert grassland: A history of vegetational change and an analysis of causes. *Bot. Review* 24: 193-252.
- Johnston, M. C. 1981. Past and present grassland of southern Texas and northeastern Mexico. *Ecology* 44:456-466.
- Langford, J. O., and F. Gipson. 1952. Big Bend, a homesteader's story. Univ. of Texas Press, Austin.
- McPherson, G. R. 1995. The role of fire in desert grasslands. Pages 130-151 in M. P. McClaran and T. R. Van Devender, eds. *The Desert Grassland*. The Univ. of Arizona Press, Tucson.

- Parker, K. W., and S. C. Martin. 1952. The mesquite problem on southern Arizona ranges. Circular No. 908. U.S. Department of Agriculture, Washington, D.C.
- Parry, C. C. 1857. *In* Emory, W. H. 1855. United States and Mexican Boundary Survey. U.S. 34th Congress, 1st and 2nd Session, Senate Ex. Doc., doc. 108, vol. 2, pt. 1, U.S. Serial Set. No. 833, pp. 9-26.
- Ueckert, D. N., and J. L. Petersen. 2002. Water conservation for restoration of wildlife habitats. Pages 101-114 *in* L. A. Harveson, P. M. Harveson, and C. L. Richardson, eds. Proceedings of the Trans-Pecos Wildlife Conference. Sul Ross State Univ., Alpine.
- Van Auken, O. W. 2000. Shrub invasions of North American semiarid grasslands. *Annu. Rev. Ecol. Syst.* 31: 197-215.
- Van Devender, T. R. 1995. Desert grassland history. Pages 68-99 *in* M. P. McClaran and T. R. Van Devender, eds. *The Desert Grassland*. The Univ. of Arizona Press, Tucson.
- Wauer, R. H. 1973. *Naturalist's Big Bend*. Texas A&M Univ. Press, College Station.
- Weniger, D. 1984. *The Explorers' Texas: The Lands and Waters*. Vol 1. Eakin Press, Austin, Tex.
- Wondzell, S. M. 1984. Recovery of desert grasslands in Big Bend National Park following 36 years of protection from grazing by domestic livestock. M. S. Thesis, New Mexico State Univ., Las Cruces.
- Wright, H. A., and A. W. Bailey. 1982. *Fire ecology: United States and Southern Canada*. John Wiley and Sons, New York.
- Wuerthner, G. 1989. *Texas' Big Bend country*. American Geographic Publishing, Helena, Mont.
- York, J. C., and W. A. Dick-Peddie. 1969. Vegetation changes in southern New Mexico during the past 100 years. Pages 157-166 *in* W. G. McGinnies and B. J. Goldman, eds., *Arid Lands in Perspective*. Univ. of Arizona, Tucson.

Appendix II

Minimum Requirements for Supplemental Shelter for the Trans-Pecos

NEW: Summary guidance for supplemental shelter intensity levels. The following documents are intended for guidance only, and represent what would be the desired number of supplemental shelters for various species that a landowner should strive for. Because each individual property is different and effective use of supplemental shelter for wildlife enhancement will vary based on individual site characteristics, these numbers should be used as guidance only. Additional information is available from your local biologist or on the TPWD web site at www.tpwd.state.tx.us/wildscapes. Be sure to study the general guidelines for agricultural tax valuation based on wildlife management. See Wildlife Management Activities And Practices: Comprehensive Wildlife Management Planning Guidelines for your region. It's the book to which this is an appendix.

Species:	Shelter type:	Minimum no. per area of suitable habitat:
Kestrels, E. Bluebird, Tufted Titmouse, Bewick's Wren, Carolina Chickadee, Flycatchers, Flickers, Barn Owls, Flying Squirrels, Fox and Gray Squirrels, Wood Ducks, Whistling Ducks	Nest Box	1 per 3 acres of mid-grass prairie or timberland. Maximum number in the aggregate: 40
Wood Ducks, Whistling Ducks, Barn Owls, Crested Flycatchers, Squirrels, Chickadees, Titmice, Wrens, Parula Warblers	Nest Box	1 per 8 acres of bottomland and riparian habitat. Maximum number in the aggregate: 20
Woodpeckers, Titmice, Wrens, Whistling Ducks, Flycatchers	Nest Box	1 per 10 acres of Native Brush or Shrub. Maximum number in the aggregate: 20
Purple Martins	Martin House	1 site per 30 acres, 8 cavities per site. Maximum number of sites: 6
Bats	Bat House	3 per 100 acres. Minimum: 3, maximum: 12
Screech Owls	Nest Box	1 per 10 acres. Maximum: 20